

## INSTALLATION INSTRUCTIONS

### In-Line Fan

Model No. FV-10NLF1E FV-20NLF1 FV-30NLF1 FV-40NLF1

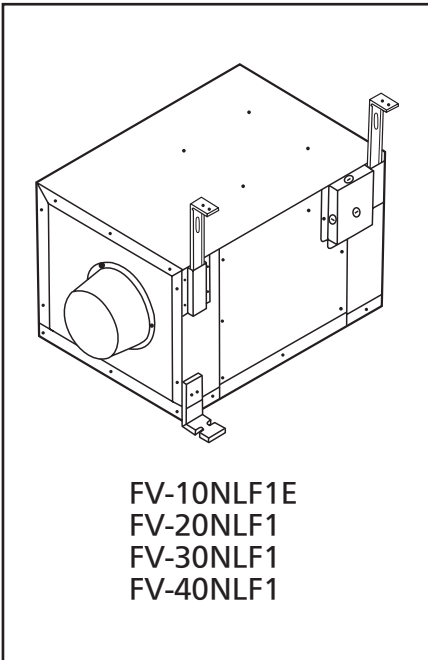

#### Contents

GENERAL SAFETY INFORMATION .....	2~3
DESCRIPTION .....	4
UNPACKING .....	4
SUPPLIED ACCESSORIES .....	4
DIMENSIONS.....	5
INSTALLATION I (HORIZONTALLY BETWEEN JOISTS).....	5~7
INSTALLATION II (ON CEILINGS/JOISTS) .....	7
INSTALLATION III (VERTICALLY ON JOISTS OR PILLARS) ....	8
MAINTENANCE .....	9
PRACTICAL GUIDE TO INSTALLATION.....	9
SPECIFICATIONS.....	10
PRODUCT SERVICE .....	10

#### READ AND SAVE THESE INSTRUCTIONS

Thank you for purchasing this Panasonic product.  
Please read these instructions carefully before attempting to install, operate or service the Panasonic product. Failure to comply with instructions could result in personal injury or property damage. Please explain to users how to operate and maintain the product after installation, and this booklet should be presented to users.  
Please retain this booklet for future reference.

---

# GENERAL SAFETY INFORMATION



---

## For Your Safety





To reduce the risk of injury, loss of life, electric shock, fire, malfunction, and damage to equipment or property, always observe the following safety precautions.

### Explanation of symbol word panels

The following symbol word panels are used to classify and describe the level of hazard, injury, and property damage caused when the denotation is disregarded and improper use is performed.







 <b>WARNING</b>	Denotes a potential hazard that could result in serious injury or death.
 <b>CAUTION</b>	Denotes a hazard that could result in minor injury.

The following symbols are used to classify and describe the type of instructions to be observed.

	This symbol is used to alert users to a specific operating procedure that must be followed in order to operate the unit safely.
	This symbol is used to alert users to a specific operating procedure that must not be performed.
	This symbol is used to alert users not to disassemble the equipment.
	This symbol is used to alert users to make sure of grounding when using the equipment with the grounding terminal.







## **WARNING**

To reduce the risk of fire, electric shock or personal injury, observe the following:













-  Use this unit only in the manner intended by the manufacturer. If you have any questions, contact the manufacturer.
-  Installation work and electrical wiring must be done by qualified person(s) in accordance with all applicable codes and standards, including fire-rated construction.  
Sufficient air is needed for proper combustion and exhausting of gases through the flue (chimney) of fuel burning equipment to prevent backdrafting. Follow the heating equipment manufacturer's guidelines and safety standards such as those published by the National Fire Protection Association (NFPA), the American Society for Heating Refrigeration and Air Conditioning Engineers (ASHRAE) and the local code authorities.
-  When cutting or drilling into a wall or ceiling, do not damage electrical wiring and other hidden utilities.
-  Ducted fans must always be vented to the outdoors.
-  Do not use this unit with any solid-state control device.
-  Before servicing or cleaning unit, switch power off at service panel and lock the service disconnecting mains to prevent power from being switched on accidentally. When the service disconnecting mains cannot be locked, securely, fasten a prominent warning device, such as a tag, to the service panel.

# GENERAL SAFETY INFORMATION

## WARNING

-  Not to be installed in a ceiling thermally insulated to a value greater than R40. (This is required for installation in Canada only.)
-  Never place a switch where it can be reached from a tub or shower.
-  A statement to the effect that when the product is to no longer be used, it must not be left in place but removed, to prevent it from possibly falling.
-  Do not disassemble the unit for reconstruction. It may cause fire or electric shock.
-  Ceiling joist must be subjected to static load more than five times the weight of the product.
-  This product must be grounded.

## CAUTION

-  Do not install this In-Line Fan where the temperature may exceed 60°C (140°F).
-  Make certain that the service supply voltage is 120V, 60Hz.
-  Follow all local electrical and safety codes as well as the National Electrical Code (NEC) and the Occupation Safety and Health Act (OSHA).
-  Always switch the power source off before working on or near the fan or motor.
-  Protect the electrical wires from sharp edges, oil, grease, hot surfaces, chemicals, or other objects.
-  Do not bend the electrical wires.
-  Do not install the unit where ducts are configured as shown in Fig.A.
-  Provide suction parts with proper ventilation.
-  For general ventilating use only. Do not use to exhaust hazardous or explosive materials or vapours.
-  Before installation, confirm that the unit is facing the right direction. (Fig.B)
-  Do not drop the unit, put it on the hanger securely.
-  The special-purpose or dedicated parts, such as mounting fixtures, must be used if such parts are provided.

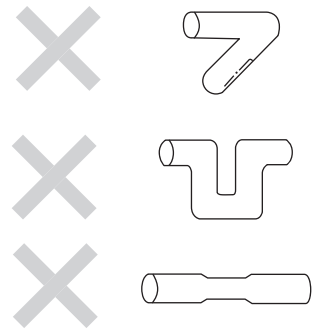

Fig.A

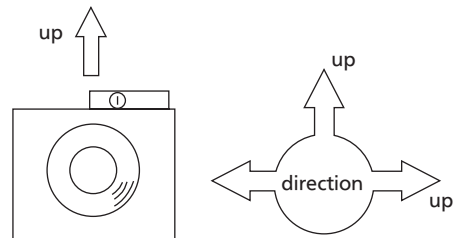

Fig.B

---

## DESCRIPTION

---

These Panasonic In-Line Fan models use a sirocco fan driven by a capacitor motor. The motor is designed to have an extended service life with reduced energy consumption, and a reduced noise level. It also incorporates a thermal cutout for safety.

---

## UNPACKING





---

Unpack and carefully remove unit from carton.  
Refer to the supplied accessories list to verify that all parts are present.

---

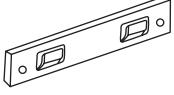
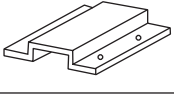
## SUPPLIED ACCESSORIES

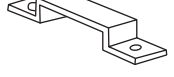
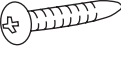
---

Part name	Illustration	Quantity
Bracket		2
Hanger		1
Bracket cover		2
Installation bracket		2
Extension bracket		2
Holder (Assembled on body)		2
Long screw		10
Self-tapping screw		12
Short screw		4

# DIMENSIONS

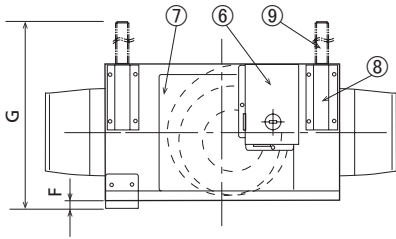
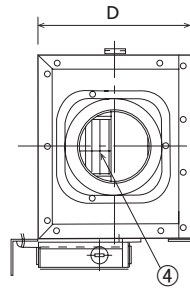
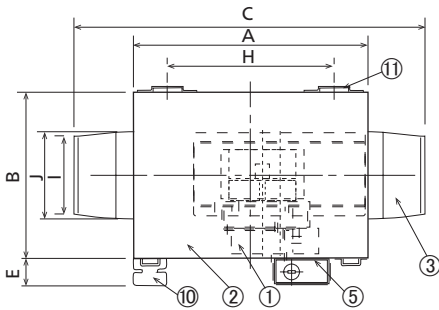

No.	Part name	No.	Part name
①	Motor	⑦	Inspection panel
②	Body	⑧	Bracket cover
③	Adapter	⑨	Installation bracket
④	Fan		Extension bracket
⑤	Junction box	⑩	Bracket
⑥	Junction box cover	⑪	Holder

Dimensions: mm(inch)

Model No.	A	B	C	D	E	F	G	H	I	J
FV-10NLF1E	340 (13 3/8)	240 (9 7/16)	440 (17 5/16)	200 (7 7/8)	38.1 (1 1/2)	8 (5/16)	321-581 (12 5/8-22 7/8)	242 (9 17/32)	∅97 (∅3 13/16)	∅112 (∅4 13/32)
FV-20NLF1	340 (13 3/8)	240 (9 7/16)	550 (21 21/32)	240 (9 7/16)	38.1 (1 1/2)	8 (5/16)	321-621 (12 5/8-24 7/16)	242 (9 17/32)	∅142 (∅5 19/32)	∅158 (∅6 7/32)
FV-30NLF1	390 (15 11/32)	270 (10 5/8)	600 (23 5/8)	280 (11 1/32)	38.1 (1 1/2)	8 (5/16)	321-661 (12 5/8-26)	242 (9 17/32)	∅142 (∅5 19/32)	∅158 (∅6 7/32)
FV-40NLF1	420 (16 17/32)	340 (13 3/8)	560 (22 1/6)	280 (11 1/32)	38.1 (1 1/2)	8 (5/16)	321-661 (12 5/8-26)	242 (9 17/32)	∅195 (∅7 11/16)	∅211 (∅8 5/16)

## INSTALLATION I (HORIZONTALLY BETWEEN JOISTS)

1. Disconnect the power to the receptacle before starting the installation.
2. Fix the hanger to the ceiling joist. Keep distance "A" between the hanger and ceiling board (table 1). Use two long screws to fasten the hanger. (Fig.1)

Dimension: mm(inch)

MODEL	FV-10NLF1E	FV-20NLF1	FV-30NLF1	FV-40NLF1
A	165 (6 1/2)	165 (6 1/2)	185 (7 1/4)	215 (8 1/2)

(table 1)

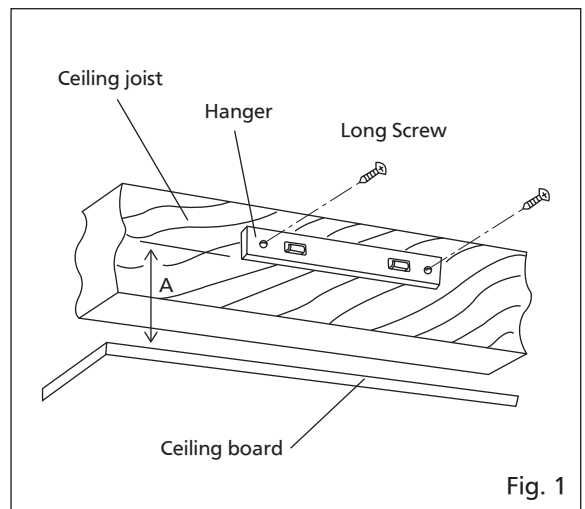

Fig. 1

# INSTALLATION I (HORIZONTALLY BETWEEN JOISTS)

- After confirming the direction that the unit will be facing, attach the bracket and bracket cover to the unit with self-tapping screws. (Fig.2)



The holder was assembled on the back side of the unit. (no shown in Fig.2)  
 Attach the unit body horizontally to the panel of your choice.  
 For best results, the bracket and bracket cover should be attached vertically.  
 The holder and the bracket should be installed on the same side of the joist.

- Insert installation bracket into bracket cover.

If joist space is greater than distance B at the center (table 2), attach installation bracket and extension bracket as shown below.

Dimension: mm(inch)

MODEL	FV-10NLF1E	FV-20NLF1	FV-30NLF1	FV-40NLF1
B	381 (15)	421 (16 1/2)	461 (18 1/8)	461 (18 1/8)

(table 2)

- Insert the holder, located on the unit, into the hanger. (Fig.3)
- Attach the In-Line Fan to a joist or a pillar with the long screws. (Fig.4)
- Remove junction box cover and secure conduit or wire holder to junction box cover knockout hole. (Fig.5)
- Using wire nuts, connect house power wire as shown in the wiring diagram.
- Replace junction box cover.



Mount junction box cover carefully so that wires are not pinched.

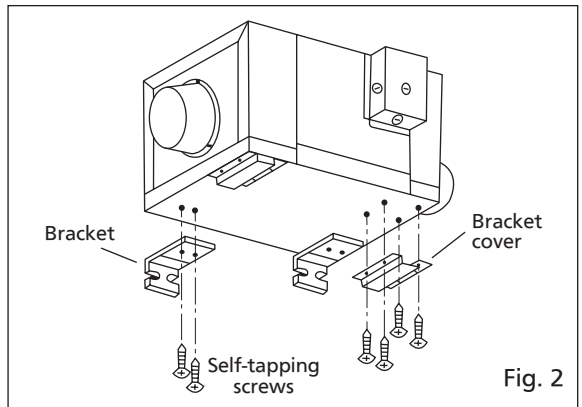

Fig. 2

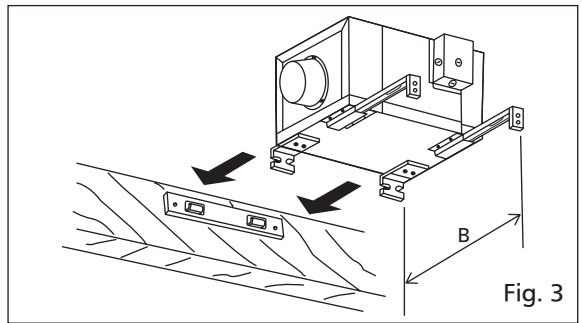

Fig. 3

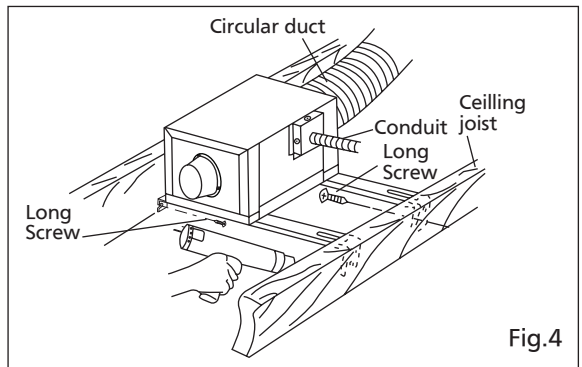

Fig.4

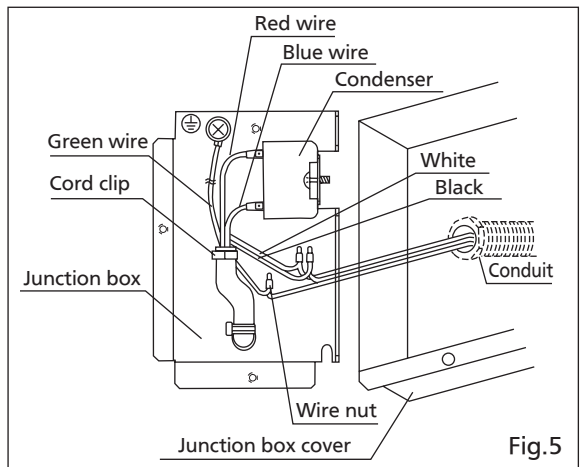
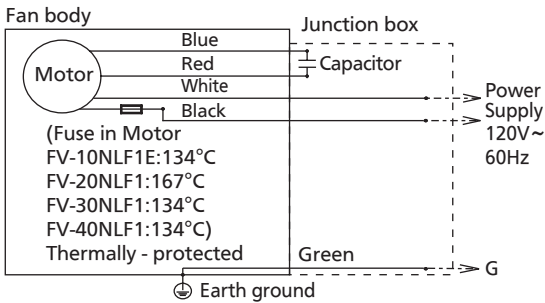

Fig.5

# INSTALLATION I (HORIZONTALLY BETWEEN JOISTS)

## Wiring Diagram



10. Install circular ducts (on both ends) and secure them with tape or clamps.  
Consult table 3 for the appropriate duct sizes.

Dimension: mm(inch)

MODEL	FV-10NLF1E	FV-20NLF1	FV-30NLF1	FV-40NLF1
duct $\varnothing$	102 (4)	152 (6)	152 (6)	203 (8)

(table 3)

11. Connect power line to receptacle after finishing duct work.

## INSTALLATION II (ON CEILINGS/JOISTS)

1. Attach installation bracket and bracket to the unit body. (Fig.6)



- Insert the installation bracket into the bracket cover attached to the panel.

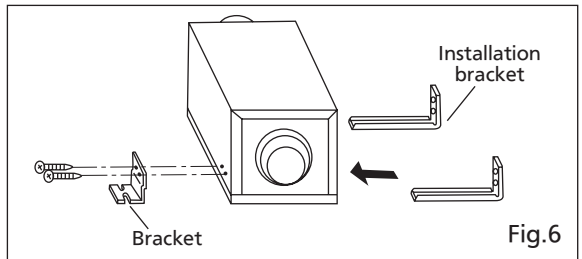

2. Extend installation bracket and put the unit on the ceiling or joist. Secure with long screws. (Fig.7)
3. Remove junction box cover and secure conduit or wire holder to junction box cover knockout hole. (Fig.5)
4. Using wire nuts, connect house power wire as shown in the wiring diagram on page 7.
5. Replace junction box cover.

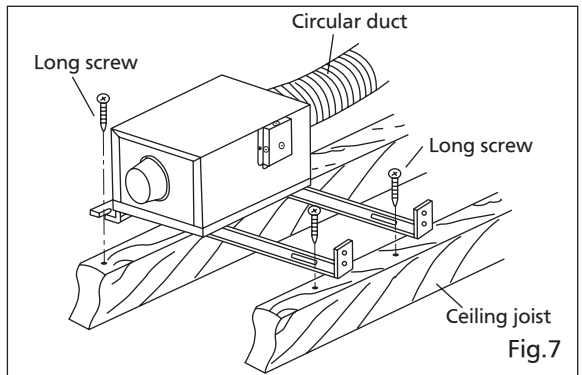

- Mount junction box cover carefully so that wires are not pinched.

6. Install circular ducts (on both ends) and secure them with tape or clamps.  
Consult table 3 for the appropriate duct sizes.

Dimension: mm(inch)

MODEL	FV-10NLF1E	FV-20NLF1	FV-30NLF1	FV-40NLF1
duct $\varnothing$	102 (4)	152 (6)	152 (6)	203 (8)

(table 3)

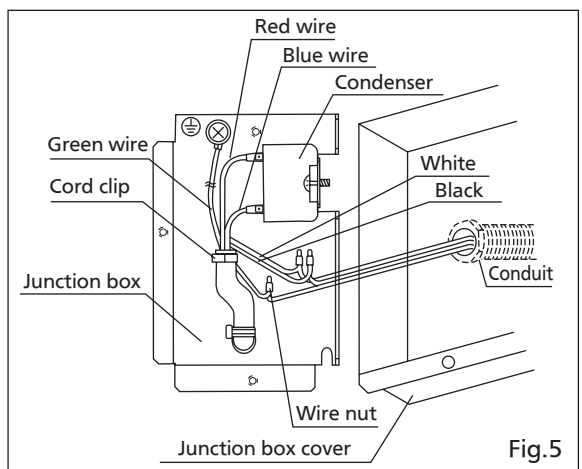

# INSTALLATION III (VERTICALLY ON JOISTS OR PILLARS)

Installing the In-Line Fan requires an accessible area (attic or air extraction apparatus)

1. Install the In-Line Fan using the first step described in INSTALLATION II.
2. Extend installation bracket and hang the unit on the joist or pillar. Fix with the long screws. (Fig.8)

## CAUTION



Be careful not to drop the unit.

3. Remove junction box cover and secure conduit or wire holder to junction box cover knockout hole. (Fig.5)
4. Using wire nuts, connect house power wire as shown in the wiring diagram.
5. Replace junction box cover.

## CAUTION



Mount junction box cover carefully so that wires are not pinched.

## Wiring Diagram

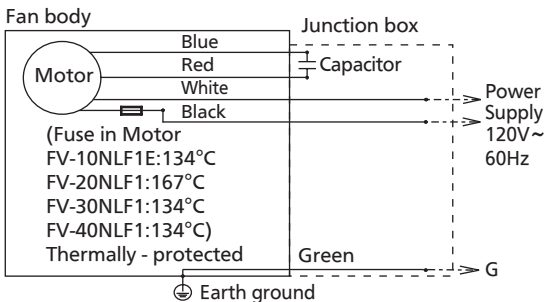

6. Install circular ducts (on both ends) and secure them with tape or clamps. Consult table 3 for the appropriate duct sizes.

Dimension: mm(inch)

MODEL	FV-10NLF1E	FV-20NLF1	FV-30NLF1	FV-40NLF1
duct $\varnothing$	102 (4)	152 (6)	152 (6)	203 (8)

(table 3)

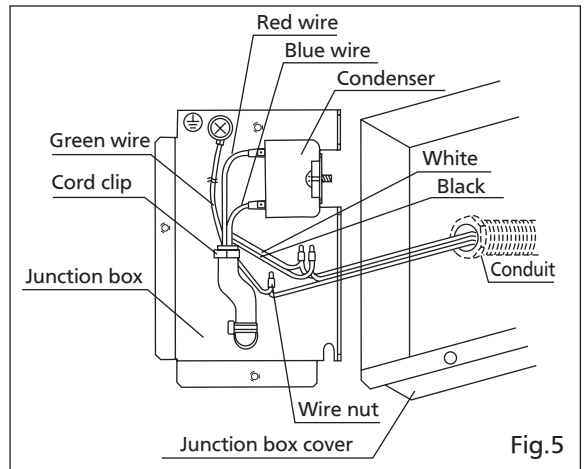
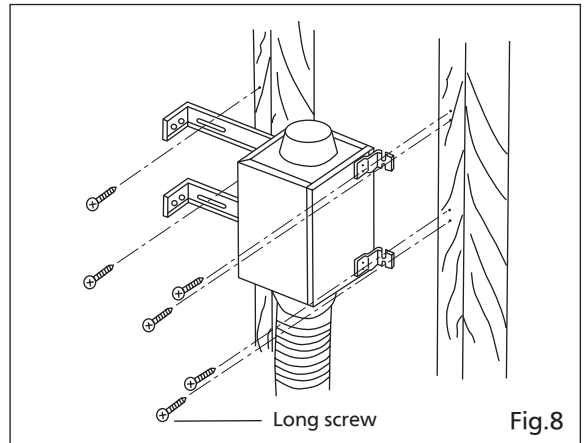
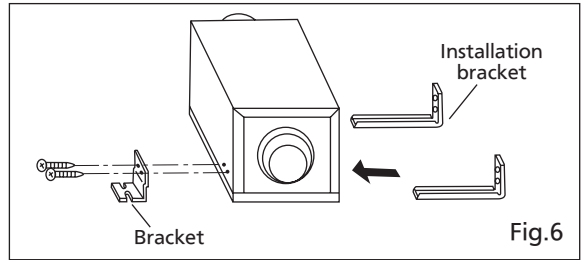



# MAINTENANCE

## ! WARNING

! Disconnect power line before proceeding with repairs or maintenance.

## ! CAUTION

- ⊘ Never use benzene based thinner or similar chemicals for cleaning the In-Line Fan.
- ⊘ Do not allow water to come into contact with the motor.
- ⊘ Do not immerse resin parts in water where the temperature is over 60°C (140° F).

1. Remove inspection panel (take off the screws and pull). (Fig.9)
2. Clean inspection panel (do not immerse in water), wipe dry with cloth.
3. Remove dust and dirt inside the fan's body using a vacuum cleaner. (Fig.10)
4. Using a cloth dampened with kitchen detergent, remove any dirt from the fan's body. Wipe dry with a cloth (do not wipe thermal insulation parts inside body with dampened cloth).
5. Replace inspection panel.

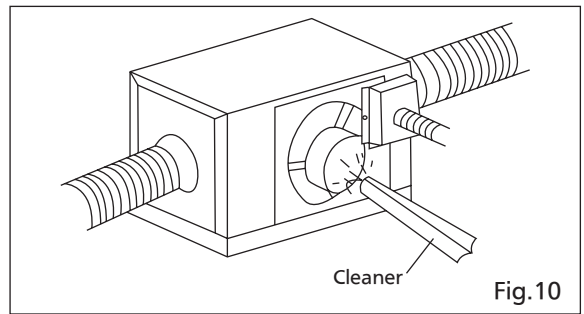
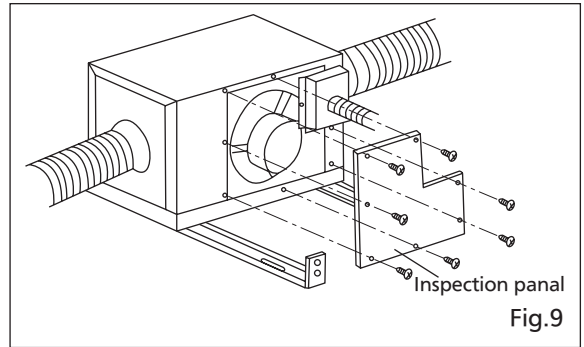

# PRACTICAL GUIDE TO INSTALLATION

Properly insulate the area around the fan to minimize building heat loss and gain. (Fig.11) Loose fill or batt insulation can be placed directly over the fan housing in the attic. Our fans and fan/light combination units do not create excessive heat that is a common problem with recessed light fixtures or some competitor's fan/light combination. Our efficient, cool-running motors and our fluorescent lamps do not create enough ambient heat to be subjected to these limitations. The ducting from this fan to the outside of the building has a strong effect on the air flow, noise and energy use of the fan. Use the shortest, straightest duct routing possible for best performance, and avoid installing the fan with smaller ducts than recommended. Insulation around the ducts can reduce energy loss and inhibit mold growth. Fans installed with existing ducts may not achieve their rated air flow.

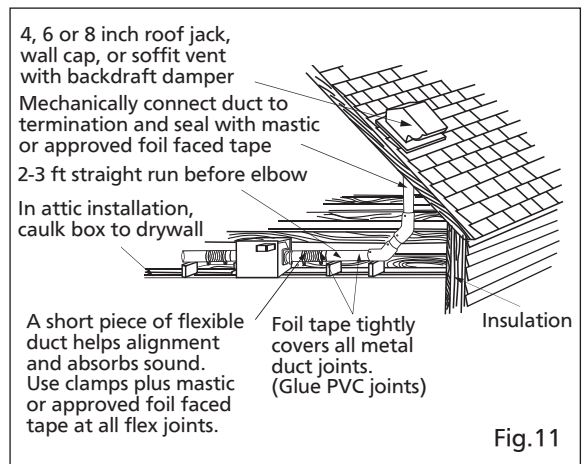

---

## SPECIFICATIONS

---

Model No.	Air direction	V	Hz	Power consumption (W)	Speed (PRM)	Air delivery (CFM)	Weight Kg (lb.)
FV-10NLF1E	Exhaust	120	60	30	1510	120	6.3(13.9)
FV-20NLF1				57	1260	240	7.5(16.5)
FV-30NLF1				98	1340	340	10.9(24.1)
FV-40NLF1				132	1150	440	11.9(26.3)

\*Power consumption, speed and air delivery values have been measured at 5mm WG (0.2" WG).

---

## PRODUCT SERVICE

---

### Warning Concerning Removal of Covers.

The unit should be serviced by qualified technicians only.

Your product is designed and manufactured to ensure a minimum of maintenance.

Should your unit require service or parts, call Panasonic Call Center at 1-866-292-7299(USA)

Or 1-800-669-5165(Canada).

---

Panasonic Corporation of North America

Two Riverfront Plaza, Newark, NJ 07102

[www.panasonic.com](http://www.panasonic.com)

Panasonic Canada Inc.

5770 Ambler Drive, Mississauga, Ontario L4W 2T3

[www.panasonic.ca](http://www.panasonic.ca)

© Panasonic Corporation 2002-2015

Printed in China