

## Intelli-Balance™ 200 Energy Recovery Ventilator

### Intelli-Balance™ 200

FV-20VEC1: Energy Recovery Ventilator (ERV)



#### HEALTHY AIR, HEALTHY HOME

True Flow rating at **0.4"** static pressure provides powerful airflow to assure code compliant, healthy homes.

[See PQ Curves]

- Multi-speed selector (60 to 200CFM) provides customizable supply and exhaust airflow to create balanced, positive or negative pressure within a residential or commercial space.
- Two (2) powerful ECM motors with Smart Flow™ technology ensure predictable airflow outputs up to .40 " w.g. of static pressure.
- Occupant controllable Boost function provides increased ventilation on demand.
- Designed for single family dwellings and new airtight envelopes built to meet energy efficiency standards.
- Engineered for use in any North America Climate Zone .
- Core material permeated with anti-mold treatment.
- Built-in ASHRAE 62.2 intermittent timing function helps ensure code compliance and simplifies the installation process.
- MERV 13 filter included for superior air filtration; MERV 13, MERV 8 and HEPA filter replacements available.
- Connect to existing ductwork or use as a standalone, whole-house ventilation solution.
- Can be used to meet Green Building Standards and contribute to better HERS/ERI scores.
- Compatible with the intelligent Cosmos™ Healthy Home System to help automatically maintain a healthy indoor environment.
- Powder coat finish for a professional look from a professional installer. No fingerprints or rust.

#### ADDITIONAL BENEFITS

- Optional LCD Wired Wall Control Panel (FV-SW20VEC1) provides ERV status, indoor and outdoor air temperatures, and humidity.
- High efficiency capillary core recovers heat and balances moisture, inside to outside
- Three installation options - floor, wall or ceiling (chain mount and brackets included)
- Adjustable supply and return air adapters provide greater Installation flexibility
- Separate control of supply and exhaust airflow. Four integrated 6" duct adapters (2 exhaust, 2 supply)
- Includes static pressure access ports with balancing instructions on the ERV for simplified commissioning
- Meets Ontario, ENERGY STAR®<sup>1</sup> and Novoclimat requirements<sup>2</sup>
- 6 Year Warranty on ECM motor, 3 Years on all other parts

<sup>1</sup> Meets strict energy efficiency guidelines set by Natural Resources Canada and is ENERGY STAR® certified for the Canadian market only

<sup>2</sup> Meets established energy efficiency standards in Canada for climate Zone 1 - fewer than 6,000 heating degree days (HDD)

# The power of performance, with exclusive smart sensing technology

## Intelli-Balance™ 200



FV-20VEC1



<sup>2</sup>Meets strict energy efficiency guidelines set by Natural Resources Canada and is ENERGY STAR® certified for the Canadian market only.

### COST EFFECTIVE, CODE COMPLIANT ERV FOR ANY CLIMATE ZONE

When large gatherings require more ventilation, call on Intelli-Balance 200 with BOOST to increase airflow. Intelli-Balance™ 200 is a powerful, high performance, high efficiency, Energy Recovery Ventilator (ERV) designed to meet ASHRAE 62.2 requirements. This unique and cost effective ERV was engineered for total versatility and installation flexibility, in any climate zone.

Built-in controls minimize the time it takes to determine desired airflow, as well as verify and maintain performance. Intelli-Balance™ 200 allows you to simply design and specify your ventilation system requirements, improving IAQ and reducing ventilation costs.

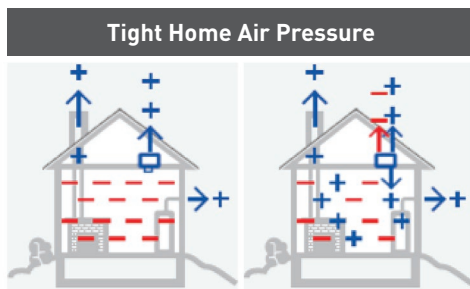
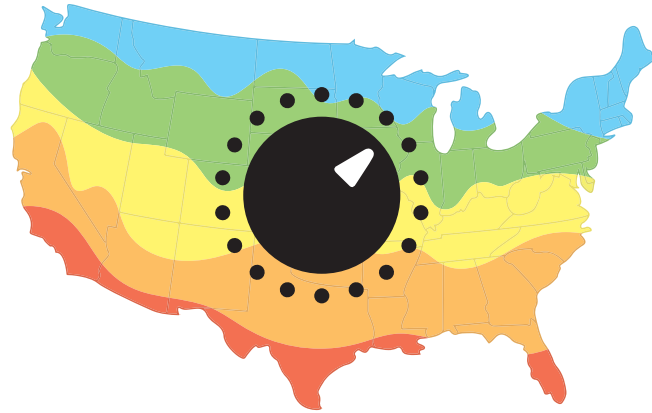

WITHOUT ERV

WITH ERV



Multi-Speed Selector

### BALANCED VENTILATION

Tightly built homes and buildings utilizing exhaust only fans can create negative pressure. Intelli-Balance™ 200 solves this by allowing the installer to adjust supply air to replace exhausted air, helping to balance air pressure within the home.

Panasonic Intelli-Balance™ 200 ERV uses four integrated 6" round duct adaptors. The Panasonic Intelli-Balance™ 200 ERV low speed, continuous run setting helps remove moist, stale air and replace it with fresh air. Exchanging stale air with fresh has been shown to reduce aerosolized virus and bacteria counts.

Intelli-Balance™ 200 can be installed on the floor, and wall or ceiling mounted (chain mount and brackets included), and does not require connection to the Central HVAC or the addition of a condensation line. This allows it to be installed in many places throughout the home to meet space and design requirements.

### ECM MOTOR TECHNOLOGY

Intelli-Balance™ 200 uses two (2) ECM brushless motors with built-in SmartFlow™ technology for precision ventilation. When the ERV senses static pressure, its speed is automatically increased to ensure desired output; regardless of a complicated duct run. This feature provides peace of mind, as the installer doesn't have to worry about compromising the ERV's performance. Both ECM motors are rated for continuous run and are totally enclosed to ensure long-life and continuous, quiet operation. Each motor is equipped with a thermal cutoff fuse.

### MULTI-SPEED SELECTOR

Intelli-Balance™ 200 includes a built-in Multi-speed selector that provides the unique ability to select your required supply (60-80-100-120-140-160-180-200 CFM) and exhaust airflow (60-80-100-120-140-160-180-200 CFM), with the simple turn of a dial. This truly customizable airflow capability allows the installer to create balanced, positive or negative pressure within the envelope.

### Accessories (Sold Separately):

**FV-FL1320VE1:** MERV 13 Optional Replacement Filter

**FV-FL0820VE1:** MERV 8 Optional Replacement Filter

**FV-FLHP20VE1:** HEPA Optional Replacement Filter



**Supply Air Filter (SA)** MERV 13 filter (included)

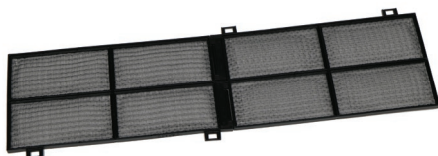

**Return Air Filter**



**Capillary Core**

## ASHRAE 62.2 INTERMITTENT TIMING FUNCTION

The adjustable Minutes Per Hour (Min/Hr) timer allows the user to set the number of minutes per hour the ERV should run. This gives scalability of air flow relative to property size; from the smallest multi-family to larger single family applications. This ensures consistent and controlled ventilation throughout the day for compliance with ASHRAE 62.2. Factory default setting is 60 Min/Hr.

## FILTERS & MAINTENANCE

Intelli-Balance™ 200 has two filters that clean the exhaust and supply air before passing through the ERV core, extending the life of the core. A hinged access panel allows for quick and easy maintenance and filter checks. A convenient indicator light and unobtrusive alarm signal from the access panel, and notification on the LCD wall control, will help inform the homeowner when it's time to check and clean the filters. Both filters should be vacuumed with a soft brush attachment every 2-3 months or as needed, and the supply air filter should be inspected every 90 days and replaced every 6 months to maintain the ERV's peak performance.

## CAPILLARY CORE

Indoor and outdoor air pass through Panasonic's patented capillary core designed to transfer heat and moisture. This process tempers supply air while balancing moisture levels inside to outside. The core's high latent energy (moisture) transfer makes Intelli-Balance 200 ideal for use in most climate zones, as it helps expel moisture during incidences of high relative humidity (RH) and helps return moisture back inside during the winter for a healthier, more comfortable living environment. Core material permeated with anti-mold treatment to help prevent mold in the home.

## WHOLE HOUSE ERV

Intelli-Balance™ 200 is a ceiling, floor or wall mount Energy Recovery Ventilator (ERV) that's ideal for meeting whole house ventilation requirements under ASHRAE 62.2. Intelli-Balance™ 200 is also an ideal choice when partnered with mini-splits or VRF Heat Pumps for fresh, balanced air with energy recovery which makes it a very affordable, cost-effective IAQ solution.

**Ideal for:** Single Family Homes ( $\leq$  7500 sq. ft., up to 7 bedrooms) / Condominiums / Apartments / Housing Authority Properties / Hotels / Studio apartments (based on ASHRAE 62.2 2010 standard.)

## ASHRAE 62.2 2010 AND 2013 STANDARD

The American Society of Heating, Refrigerating and Air Conditioning Engineers (ASHRAE) set a standard for whole house ventilation, requiring continuous mechanical ventilation be 7.5 CFM per bedroom (master bedroom X 2) plus 1 CFM per 100 square feet, with sound not to exceed 1.0. ASHRAE 62.2-2013 requires a ventilation rate of 7.5 CFM per person plus 3 CFM per 100 square feet. Please check with your local jurisdiction to determine which ventilation standard you should follow. Panasonic Intelli-Balance™ 200 ERV is an affordable, efficient way to meet the ASHRAE 62.2 standard.

## OPERATION

The Intelli-Balance™ 200 can operate in areas where temperatures can drop as low as -22°F (-30°C). The Intelli-Balance™ 200 features a defrost cycle function that activates when outdoor temperature drops to 14°F, (-10°C). This helps protect the capillary core from frost build up, and maintain effective operation.



### Adjustable Supply and Return Air Adaptors

Adjustable supply and return air adaptors provide **greater installation flexibility.**

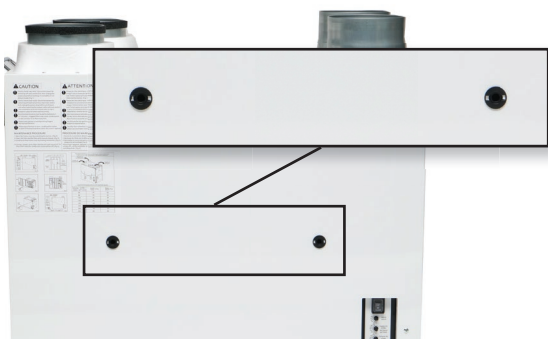

Static Pressure Access Ports

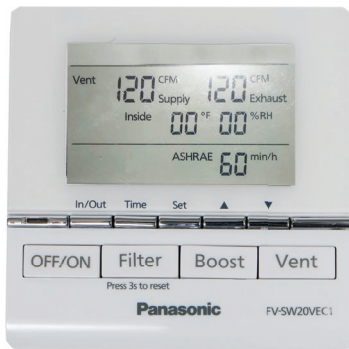

LCD Wall Control



## INSTALLATION

**Mounting:** Intelli-Balance™ 200 can easily be installed on the floor, from the ceiling or on the wall using the included chain mount or cleat hanger bar. Various mounting cleat positions allow for multiple wall installation configurations. Intelli-Balance™ 200 can also be chain mounted and suspended. Adjustable brackets and screws are provided to secure the unit to the joist on 4 corners.

**Wiring:** Power consumption at 200CFM, is 129 Watts at .4 static pressure with a power rating of 120/60 V/Hz.

**Duct:** Insulated 6" duct is recommended.

**Static Pressure Access Ports:** Intelli-Balance™ 200 incorporates static pressure ports for measuring the differential pressure of fresh air and exhaust air for balancing airflows.

## LCD WALL CONTROL

The all-new ERV LCD Wall Control puts total control and monitoring of Intelli-Balance 200 at your fingertips. Easy operation from nine push buttons and an LCD display gives homeowners instant access to custom ventilation control settings and real-time air flow and temperature monitoring.

### Functions & Settings

- Power on/off
- Air volume for supply and exhaust
- ASHRAE intermittent timer and air volume
- BOOST mode control
  - Sets supply and exhaust air to constant 200 CFM
  - Timer for BOOST activation adjustable from 10-60 minutes
- Filter reset

### Display information

- Indoor/outdoor temperature and humidity
- Filter maintenance reminder
- ASHRAE air volume and boost timer
- Cosmos mode indicator
- Defrost mode indicator
- Supply and exhaust air volume
- System fault codes

## COSMOS Healthy Home System (available in the USA only)

The Cosmos Healthy Home System monitors indoor air quality 24 x 7. Cosmos activates ventilation fans automatically and removes contaminated air from your home and brings in fresh air from outside.

Coming Soon: The Intelli-Balance™ 200 is Cosmos compatible by using an optional Cosmos communication module and will have several control functions through the Cosmos mobile application.

**FV-20VEC1 200 CFM 6" Ducts**

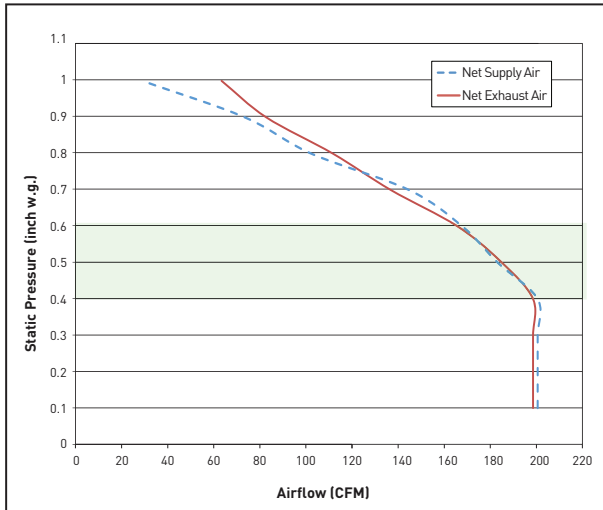

**FV-20VEC1**

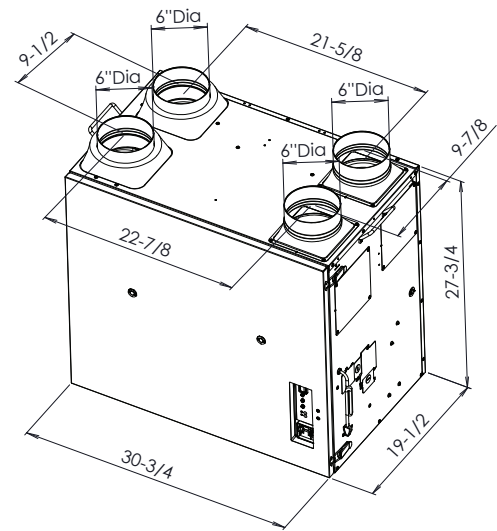

Intelli-Balance™ 200	FV-20VEC1
<b>Characteristics</b>	<b>COLD/TEMPERATE CLIMATE</b>
Static pressure in inches w.g.	0.4
Net Exhaust Air Volume (CFM)	200
Net Supply Air Volume (CFM)	200
Power Consumption (Watts)	129
Power Rating (V/Hz)	120/60
ENERGY STAR® Certified	Yes*

Energy Performance								
MODE	Supply Temperature		Net Air Flow		Power Consumed (Watts)	Sensible Recovery Efficiency	Apparent Sensible Effectiveness	Net Moisture Transfer
	°F	°C	L/S	CFM				
Heating	32	0	32	67	22	83%	86%	81%
	32	0	59	124	46	77%	79%	73%
	32	0	80	170	92	73%	77%	78%
	-13	-25	31	66	46	67%	69%	70%
	-13	-25	50	107	104	61%	64%	64%
Cooling						Total Recovery Efficiency		
	95	35	34	71	25	70%		
	95	35	64	135	56	61%		

Intelli-Balance Accessory Kits					
Model No.	Description	Inlet Grille	Backdraft Damper	Clamp	Y-Adapter
FV-NLF04G	4" Inlet Grille + Metal Plate	1 (4")	-	-	-
FV-NLF06G	6" Inlet Grille + Metal Plate	1 (6")	-	-	-
PC-NLF04S	4" Single Inlet Kit	1 (4")	1 (4")	6	-
PC-NLF06S	6" Single Inlet Kit	1 (6")	1 (6")	6	-
PC-NLF04D	4" Double Inlet Kit	2 (4")	2 (4")	12	1 (4"- 4" x 2)
PC-NLF06D	6" Double Inlet Kit	2 (6")	2 (6")	12	1 (6"- 6" x 2)
PC-NLF64D	6" - 4" Double Inlet Kit	2 (4")	2 (4")	12	1 (6"- 4" x 2)
PC-NLF86Y	8" - 6" Y-Adapter	-	-	-	1 (8"- 6" x 2)
FV-NLF46RES	Recessed Inlet integrated dual 4" or 6" duct adaptor	-	-	-	-

\* Meets strict energy efficiency guidelines set by Natural Resources Canada and is ENERGY STAR® certified for the Canadian market only



**Panasonic Canada Inc.**  
5770 Ambler Drive  
Mississauga, Ontario L4W 2T3  
[na.panasonic.com/ca/ventilation](http://na.panasonic.com/ca/ventilation)

**For Order Information**  
Phone: 1-800-669-5165  
[EPSorders@ca.panasonic.com](mailto:EPSorders@ca.panasonic.com)