

Service Manual

Air Conditioner

Outdoor Unit
CU-3E19RBU
CU-4E24RBU

Destination
U.S.A.
Canada

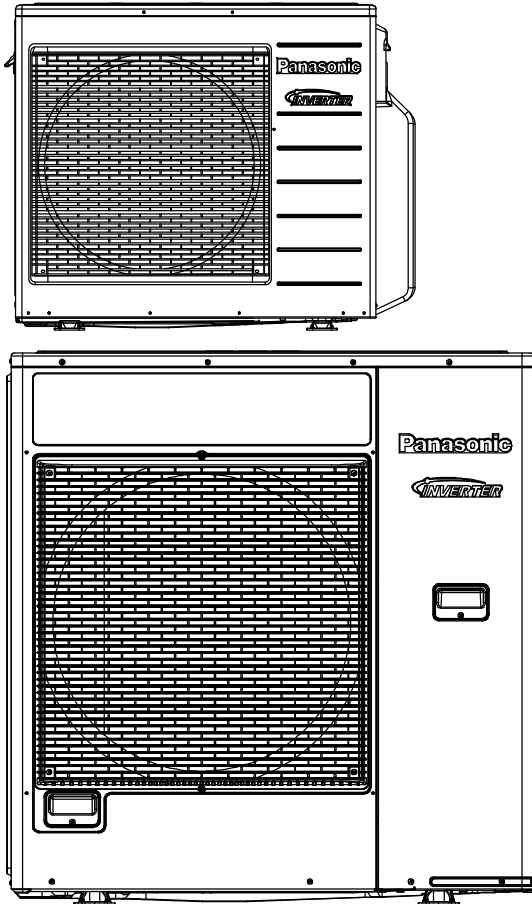

Please file and use this manual together with the service manual for Model No. CS-E9RKUAW CS-E12RKUAW CS-E18RKUAW, CS-E24RKUAW, CS-ME7RKUA, CS-E12RB4UW, CS-E18RB4UW, CS-ME5RKUA, Order No. PAPAMY1501049CE, PAPAMY1503094CE, PAPAMY1503095CE, PAPAMY1505112CE.

WARNING

This service information is designed for experienced repair technicians only and is not designed for use by the general public. It does not contain warnings or cautions to advise non-technical individuals of potential dangers in attempting to service a product. Products powered by electricity should be serviced or repaired only by experienced professional technicians. Any attempt to service or repair the product or products dealt with in this service information by anyone else could result in serious injury or death.

IMPORTANT SAFETY NOTICE

There are special components used in this equipment which are important for safety. These parts are marked by  in the Schematic Diagrams, Circuit Board Diagrams, Exploded Views and Replacement Parts List. It is essential that these critical parts should be replaced with manufacturer's specified parts to prevent shock, fire or other hazards. Do not modify the original design without permission of manufacturer.

PRECAUTION OF LOW TEMPERATURE

In order to avoid frostbite, be assured of no refrigerant leakage during the installation or repairing of refrigerant circuit.



Panasonic[®]

TABLE OF CONTENTS

	PAGE		PAGE
1. Safety Precautions	3	13.12 IPM (power transistor) Protection Control	47
2. Specifications	5	13.13 Compressor Protection Control (Gas leak detection control 1)	47
2.1 CU-3E19RBU	5	13.14 Compressor Protection Control (Gas leak detection control 2)	47
2.2 CU-4E24RBU	7	13.15 Valve close detection control.....	48
3. Dimensions	16	13.16 Compressor discharge high pressure protection control	48
3.1 CU-3E19RBU	16	14. Servicing Mode	49
3.2 CU-4E24RBU	16	14.1 CU-3E19RBU	49
4. Refrigeration Cycle Diagram	17	14.2 CU-4E24RBU	51
4.1 CU-3E19RBU	17	15. Troubleshooting Guide	53
4.2 CU-4E24RBU	18	15.1 Self Diagnosis Function.....	53
5. Block Diagram	19	15.2 Self-diagnosis Method.....	55
5.1 CU-3E19RBU	19	16. Disassembly and Assembly Instructions	79
5.2 CU-4E24RBU	20	16.1 Outdoor Unit Removal Procedure (CU-3E19RBU).....	79
6. Wiring Connection Diagram	21	16.2 Outdoor Unit Removal Procedure (CU-4E24RBU).....	81
6.1 CU-3E19RBU	21	17. Technical Data	84
6.2 CU-4E24RBU	22	17.1 CU-3E19RBU	84
7. Electronic Circuit Diagram	23	17.2 CU-4E24RBU	108
7.1 CU-3E19RBU	23	18. Exploded View and Replacement Parts List	191
7.2 CU-4E24RBU	24	18.1 CU-3E19RBU	191
8. Printed Circuit Board	25	18.2 CU-4E24RBU	194
8.1 Main Printed Circuit Board	25		
8.2 Noise Filter Printed Circuit Board.....	27		
8.3 Display Printed Circuit Board	28		
9. Installation Information	29		
9.1 CU-3E19RBU	29		
9.2 CU-4E24RBU	30		
10. Installation Instruction	31		
10.1 CU-3E19RBU	31		
10.2 CU-4E24RBU	36		
11. Operation Control	41		
11.1 Cooling Operation.....	41		
11.2 Heating Operation	42		
12. Simultaneous Operation Control	43		
13. Protection Control	44		
13.1 Freeze Prevention control (Cool)	44		
13.2 Dew Prevention control (Cool)	44		
13.3 Electronic Parts Temperature Rise Protection 1 (Cool).....	44		
13.4 Electronic Parts Temperature Rise Protection 2 (Cool).....	44		
13.5 Cooling overload control (Cool).....	45		
13.6 Heating overload control (Heat)	45		
13.7 Extreme Low Temperature Compressor low pressure protection control (Heat)	46		
13.8 Deice Control.....	46		
13.9 Time Delay Safety Control (Restart Control).....	46		
13.10 30 seconds Force Operation	46		
13.11 Total Current Control.....	46		

1. Safety Precautions





- Read the following “SAFETY PRECAUTIONS” carefully before perform any servicing.
- Electrical work must be installed or serviced by a licensed electrician. Be sure to use the correct rating of the power plug and main circuit for the model installed.
- The caution items stated here must be followed because these important contents are related to safety. The meaning of each indication used is as below. Incorrect installation or servicing due to ignoring of the instruction will cause harm or damage, and the seriousness is classified by the following indications.

 WARNING	This indication shows the possibility of causing death or serious injury.
 CAUTION	This indication shows the possibility of causing injury or damage to properties.



- The items to be followed are classified by the symbols:

	This symbol denotes item that is PROHIBITED from doing.
---	---







- Carry out test run to confirm that no abnormality occurs after the servicing. Then, explain to user the operation, care and maintenance as stated in instructions. Please remind the customer to keep the operating instructions for future reference.

 WARNING	
1. Do not modify the machine, part, material during repairing service.	
2. If wiring unit is supplied as repairing part, do not repair or connect the wire even only partial wire break. Exchange the whole wiring unit.	
3. Do not wrench the fasten terminal. Pull it out or insert it straightly.	
4. Engage dealer or specialist for installation and servicing. If installation or servicing done by the user is defective, it will cause water leakage, electrical shock or fire.	
5. Install according to this installation instructions strictly. If installation is defective, it will cause water leakage, electric shock or fire.	
6. Use the attached accessories parts and specified parts for installation and servicing. Otherwise, it will cause the set to fall, water leakage, fire or electrical shock.	
7. Install at a strong and firm location which is able to withstand the set's weight. If the strength is not enough or installation is not properly done, the set will drop and cause injury.	
8. For electrical work, follow the local national wiring standard, regulation and the installation instruction. An independent circuit and single outlet must be used. If electrical circuit capacity is not enough or defect found in electrical work, it will cause electrical shock or fire.	
9. This equipment is strongly recommended to install with Earth Leakage Circuit Breaker (ELCB) or Residual Current Device (RCD). Otherwise, it may cause electrical shock and fire in case equipment breakdown or insulation breakdown.	
10. Do not use joint cable for indoor/outdoor connection cable. Use the specified indoor/outdoor connection cable, refer to Installation Instruction CONNECT THE CABLE TO THE INDOOR UNIT and connect tightly for indoor/outdoor connection. Clamp the cable so that no external force will be acted on the terminal. If connecting or fixing is not perfect, it will cause heat up or fire at the connection.	
11. Wire routing must be properly arranged so that control board cover is fixed properly. If control board cover is not fixed perfectly, it will cause heat-up or fire at the connection point of terminal, fire or electrical shock.	
12. When install or relocate air conditioner, do not let any substance other than the specified refrigerant, eg. air etc. mix into refrigeration cycle (piping). (Mixing of air etc. will cause abnormal high pressure in refrigeration cycle and result in explosion, injury etc.).	
13. Do not install outdoor unit near handrail of veranda. When installing air-conditioner unit at veranda of high rise building, child may climb up to outdoor unit and cross over the handrail and causing accident.	
14. This equipment must be properly earthed. Earth line must not be connected to gas pipe, water pipe, earth of lightning rod and telephone. Otherwise, it may cause electric shock in case equipment breakdown or insulation breakdown.	
15. Keep away from small children, the thin film may cling to nose and mouth and prevent breathing.	
16. Do not use unspecified cord, modified cord, joint cord or extension cord for power supply cord. Do not share the single outlet with other electrical appliances. Poor contact, poor insulation or over current will cause electrical shock or fire.	
17. Tighten the flare nut with torque wrench according to specified method. If the flare nut is over-tightened, after a long period, the flare may break and cause refrigerant gas leakage.	

 **WARNING**

- | | |
|--|---|
| 18. For R410A models, when connecting the piping, do not use any existing (R22) pipes and flare nuts. Using such same may cause abnormally high pressure in the refrigeration cycle (piping), and possibly result in explosion and injury. Use only R410A materials.
Thickness of copper pipes used with R410A must be more than 1/32" (0.8mm). Never use copper pipes thinner than 1/32" (0.8mm).
It is desirable that the amount of residual oil is less than 0.0014 oz/32.8 ft (40 mg/10m). |  |
| 19. During installation, install the refrigerant piping properly before run the compressor. (Operation of compressor without fixing refrigeration piping and valves at opened condition will cause suck-in of air, abnormal high pressure in refrigeration cycle and result in explosion, injury etc.). | |
| 20. During pump down operation, stop the compressor before remove the refrigeration piping. (Removal of refrigeration piping while compressor is operating and valves are opened condition will cause suck-in of air, abnormal high pressure in refrigeration cycle and result in explosion, injury etc.). | |
| 21. After completion of installation or service, confirm there is no leakage or refrigerant gas. It may generate toxic gas when the refrigerant contacts with fire. | |
| 22. Ventilate if there is refrigerant gas leakage during operation. It may cause toxic gas when refrigerant contacts with fire. | |
| 23. Do not insert your fingers or other objects into the unit, high speed rotating fan may cause injury. |  |
| 24. Must not use other parts except original parts described in catalog and manual. | |
| 25. Using of refrigerant other than the specified type may cause product damage, burst and injury etc. | |

 **CAUTION**

- | | |
|--|---|
| 1. Do not install the unit at place where leakage of flammable gas may occur. In case gas leaks and accumulates at surrounding of the unit, it may cause fire. |  |
| 2. Carry out drainage piping as mentioned in installation instructions. If drainage is not perfect, water may enter the room and damage the furniture. | |
| 3. Tighten the flare nut with torque wrench according to specified method. If the flare nut is over-tightened, after a long period, the flare may break and cause refrigerant gas leakage. | |
| 4. Do not touch outdoor unit air inlet and aluminium fin. It may cause injury. |  |
| 5. Select an installation location which is easy for maintenance. | |
| 6. Pb free solder has a higher melting point than standard solder; typically the melting point is 50°F – 70°F (30°C – 40°C) higher. Please use a high temperature solder iron. In case of the soldering iron with temperature control, please set it to 700 ± 20°F (370 ± 10°C). Pb free solder will tend to splash when heated too high (about 1100°F / 600°C). | |
| 7. Power supply connection to the room air conditioner.
Power supply cord shall be UL listed or CSA approved 3 conductor with minimum AWG12 wires.
Power supply point should be in an easily accessible place for power disconnection in case of emergency.
In some countries, permanent connection of this air conditioner to the power supply is prohibited.
Fix power supply connection to a circuit breaker for permanent connection.
Use NRTL approved fuse or circuit breaker (rating refers to name plate) for permanent connection. | |
| 8. Do not release refrigerant during piping work for installation, servicing, reinstallation and during repairing a refrigerant parts.
Take care of the liquid refrigerant, it may cause frostbite. |  |
| 9. Installation or servicing work: It may need two people to carry out the installation or servicing work. | |
| 10. Do not install this appliance in a laundry room or other location where water may drip from the ceiling, etc. |  |
| 11. Do not sit or step on the unit, you may fall down accidentally. |  |
| 12. Do not touch the sharp aluminum fins or edges of metal parts.
If you are required to handle sharp parts during installation or servicing, please wear hand glove.
Sharp parts may cause injury. |  |

2. Specifications

2.1 CU-3E19RBU

Item		Unit	OUTDOOR UNIT	
Indoor Unit Combination			1.6kW + 2.0kW + 2.0kW	
Power Source			1 Phase, 208-230V, 60Hz (Power supply from outdoor unit)	
Cooling Operation	Capacity	kW	5.58 (1.8 ~ 7.3)	
		BTU/h	19000 (6100 ~ 24800)	
	Electrical Data	Running Current	A	7.4 - 6.7
		Power Input	kW	1.51 (0.36 ~ 2.42)
		EER	W/W	3.68 (5.00 ~ 3.02)
	BTU/hW		12.55 (16.95 ~ 10.25)	
Noise	Sound Pressure Level	dB-A (H/L)	50 / -	
	Sound Power Level	dB (H/L)	66 / -	
Heating Operation	Capacity	kW	7.65 (1.6 ~ 8.3)	
		BTU/h	26000 (5500 ~ 28400)	
	Electrical Data	Running Current	A	10.1 - 9.1
		Power Input	kW	2.06 (0.32 ~ 2.30)
		COP	W/W	3.70 (5.00 ~ 3.61)
	BTU/hW		12.60 (17.20 ~ 12.35)	
Noise	Sound Pressure Level	dB-A (H/L)	52 / -	
	Sound Power Level	dB (H/L)	68 / -	
Maximum Current		A	15.0	
Starting Current		A	10.1	
Circuit Breaker Capacity		A	30	
Dimension	Height	mm (inch)	795 (31-5/16)	
	Width	mm (inch)	875 + 95 (34-15/32) + (3-3/4)	
	Depth	mm (inch)	320 (12-5/8)	
Net Weight		kg (lb)	72 (159)	
Connection Cable			3 + 1 (Earth) min AWG16	
Pipe Length Range (1 room)		m (ft)	3 ~ 25 (9.8 ~ 82.0)	
Maximum Pipe Length (Total Room)		m (ft)	50 (164.0)	
Refrigerant Pipe Diameter	Liquid Side	mm (inch)	6.35 (1/4)	
	Gas Side	mm (inch)	9.52 (3/8)	
Compressor	Type		Hermetic Motor / Rotary	
	Motor Type		Brushless (4-poles)	
	Rated Output	W	1.30k	
Air Circulation	Type		Propeller Fan	
	Motor Type		DC Motor (8-poles)	
	Rated Output	W	60	
Fan Speed	High (Cooling / Heating)	RPM	580 / 650	
Heat Exchanger	Type		Plate fin configuration forced draft type	
	Tube Material		Copper	
	Fin Material		Aluminum (Blue Coated)	
	Row / Stage		2 / 36	
	FPI		19	
Air Volume	High (Cooling / Heating)	m ³ /min (ft ³ /min)	41.0 (1447) / 46.3 (1634)	
Refrigerant Control Device			Expansion Valve	
Refrigerant Oil			FV50S	

Item		Unit	OUTDOOR UNIT		
Refrigerant (R410A)		g (oz)	2.64k (93.2)		
			Dry Bulb	Wet Bulb	
Indoor Operation Range	Cooling	Maximum	°C (°F)	32 (89.6)	23 (73.4)
		Minimum	°C (°F)	16 (60.8)	11 (51.8)
	Heating	Maximum	°C (°F)	30 (86.0)	—
		Minimum	°C (°F)	16 (60.8)	—
Outdoor Operation Range	Cooling	Maximum	°C (°F)	46 (114.8)	26 (78.8)
		Minimum	°C (°F)	-10 (14.0)	—
	Heating	Maximum	°C (°F)	24 (75.2)	18 (64.4)
		Minimum	°C (°F)	-15 (5.0)	-16 (3.2)

Multi Indoor RPM		CS-ME5RKUA		CS-ME7RKUA		CS-E9RKUAW		CS-E12RKUAW		CS-E18RKUAW	
Mode	Fan Tap	rpm	Airflow (m ³ /min)	rpm	Airflow (m ³ /min)	rpm	Airflow (m ³ /min)	rpm	Airflow (m ³ /min)	rpm	Airflow (m ³ /min)
COOL	SHi	1080	11.71	1110	12.10	1140	12.21	1280	13.35	1370	18.96
	Hi	990	10.70	1020	11.10	1050	11.20	1160	12.00	1330	18.40
	Me	820	8.80	840	9.08	850	8.96	940	9.54	1160	16.03
	Lo	660	7.00	660	7.06	660	6.83	720	7.08	990	13.65
	Lo-	570	6.00	570	6.06	570	5.83	580	5.51	900	12.40
HEAT	SSH	1210	12.70	1240	13.11	1270	13.21	1370	14.29	1460	20.46
	SHi	1120	11.70	1150	12.10	1180	12.20	1300	13.50	1370	19.20
	Me	950	9.79	960	9.97	980	9.96	1140	11.71	1210	16.97
	Lo	780	7.89	780	7.96	780	7.72	980	9.92	1060	14.87
	Lo-	690	6.88	690	6.95	690	6.71	890	8.91	960	13.48

Note

- Specifications are subject to change without notice for further improvement.

2.2 CU-4E24RBU

Item		Unit	OUTDOOR UNIT	
Indoor Unit Combination			1.6kW + 1.6kW + 2.0kW + 2.0kW	
Power Source			1 Phase, 208-230V, 60Hz (Power supply from outdoor unit)	
Cooling Operation	Capacity		kW	7.02 (3.0 ~ 9.2)
			BTU/h	24000 (10200 ~ 31400)
	Electrical Data	Running Current	A	9.9 - 8.9
		Power Input	kW	1.91 (0.53 ~ 2.87)
		EER	W/W	3.66 (5.66 ~ 3.21)
	BTU/hW		12.55 (19.25 ~ 10.95)	
	Noise	Sound Pressure Level	dB-A (H/L)	55 / -
Sound Power Level		dB (H/L)	71 / -	
Heating Operation	Capacity		kW	11.1 (4.2 ~ 14.2)
			BTU/h	37800 (14300 ~ 48500)
	Electrical Data	Running Current	A	15.3 - 13.9
		Power Input	kW	3.03 (0.70 ~ 4.38)
		COP	W/W	3.66 (6.00 ~ 3.24)
	BTU/hW		12.45 (20.45 ~ 11.05)	
	Noise	Sound Pressure Level	dB-A (H/L)	55 / -
Sound Power Level		dB (H/L)	71 / -	
Maximum Current		A	21.1	
Starting Current		A	15.3	
Circuit Breaker Capacity		A	45	
Dimension	Height	mm (inch)	999 (39-11/32)	
	Width	mm (inch)	940 (37-1/32)	
	Depth	mm (inch)	340 (13-13/32)	
Net Weight		kg (lb)	83 (183)	
Connection Cable			3 + 1 (Earth) min AWG16	
Pipe Length Range (1 room)		m (ft)	3 ~ 25 (9.8 ~ 82.0)	
Maximum Pipe Length (Total Room)		m (ft)	70 (229.6)	
Refrigerant Pipe Diameter	Liquid Side	mm (inch)	6.35 (1/4)	
	Gas Side	mm (inch)	9.52 (3/8), (E24: 12.70 (1/2))	
Compressor	Type		Hermetic Motor / Rotary	
	Motor Type		Brushless (4-poles)	
	Rated Output	W	1.30k	
Air Circulation	Type		Propeller Fan	
	Motor Type		DC Motor (8-poles)	
	Rated Output	W	90	
Fan Speed	High (Cooling / Heating)	RPM	600 / 700	
Heat Exchanger	Type		Plate fin configuration forced draft type	
	Tube Material		Copper	
	Fin Material		Aluminum (Blue Coated)	
	Row / Stage		2 / 46	
	FPI		19	
Air Volume	High (Cooling / Heating)	m ³ /min (ft ³ /min)	55.6 (1963) / 66.0 (2330)	
Refrigerant Control Device			Expansion Valve	
Refrigerant Oil			FV50S	
Refrigerant (R410A)		g (oz)	3.40k (120)	

Item			Unit	OUTDOOR UNIT	
				Dry Bulb	Wet Bulb
Indoor Operation Range	Cooling	Maximum	°C (°F)	32 (89.6)	23 (73.4)
		Minimum	°C (°F)	16 (60.8)	11 (51.8)
	Heating	Maximum	°C (°F)	30 (86.0)	—
		Minimum	°C (°F)	16 (60.8)	—
Outdoor Operation Range	Cooling	Maximum	°C (°F)	46 (114.8)	26 (78.8)
		Minimum	°C (°F)	-10 (14.0)	—
	Heating	Maximum	°C (°F)	24 (75.2)	18 (64.4)
		Minimum	°C (°F)	-15 (5.0)	-16 (3.2)

Multi Indoor RPM		CS-ME5RKUA		CS-ME7RKUA		CS-E9RKUAW		CS-E12RKUAW		CS-E18RKUAW		CS-E24RKUAW	
Mode	Fan Tap	rpm	Airflow (m ³ /min)	rpm	Airflow (m ³ /min)	rpm	Airflow (m ³ /min)	rpm	Airflow (m ³ /min)	rpm	Airflow (m ³ /min)	rpm	Airflow (m ³ /min)
COOL	SHi	1080	11.71	1110	12.10	1140	12.21	1280	13.35	1370	18.96	1460	19.94
	Hi	990	10.70	1020	11.10	1050	11.20	1160	12.00	1330	18.40	1350	18.40
	Me	820	8.80	840	9.08	850	8.96	940	9.54	1160	16.03	1180	16.03
	Lo	660	7.00	660	7.06	660	6.83	720	7.08	990	13.65	1020	13.79
	Lo-	570	6.00	570	6.06	570	5.83	580	5.51	900	12.40	930	12.54
HEAT	SSHi	1210	12.70	1240	13.11	1270	13.21	1370	14.29	1460	20.46	1500	20.35
	SHi	1120	11.70	1150	12.10	1180	12.20	1300	13.50	1370	19.20	1460	19.80
	Me	950	9.79	960	9.97	980	9.96	1140	11.71	1210	16.97	1310	17.70
	Lo	780	7.89	780	7.96	780	7.72	980	9.92	1060	14.87	1160	15.61
	Lo-	690	6.88	690	6.95	690	6.71	890	8.91	960	13.48	1050	14.07

Note

- Specifications are subject to change without notice for further improvement.

- **Multi Split Combination Possibility:**

- A single outdoor unit enables air conditioning of up to three separate rooms for CU-3E19RBU.
- A single outdoor unit enables air conditioning of up to four separate rooms for CU-4E24RBU.

CONNECTABLE INDOOR UNIT			OUTDOOR UNIT						
			CU-4E24RBU				CU-3E19RBU		
Type	ROOM		A	B	C	D	A	B	C
Wall	1.6kW	CS-ME5RKUA	●	●	●	●	●	●	●
	2.0kW	CS-ME7RKUA	●	●	●	●	●	●	●
	2.5kW	CS-E9RKUAW	●	●	●	●	●	●	●
	3.2kW	CS-E12RKUAW, CS-E12RB4UW	●	●	●	●	●	●	●
	5.0kW	CS-E18RKUAW, CS-E18RB4UW	●	●	●	●	●	●	●
	7.0kW	CS-E24RKUAW	●	●	●	●	-	-	-
Capacity range of connectable indoor units			From 4.5kW to 13.6kW				From 4.5kW to 9.0kW		
Pipe length	1-room maximum pipe length (m (ft))		25 (82.0)				25 (82.0)		
	Allowable elevation (m (ft))		15 (49.2)				15 (49.2)		
	Total allowable pipe length (m (ft))		70 (229.6)				50 (164.0)		
	Total pipe length for maximum chargeless length (m (ft))		45 (147.6)				30 (98.4)		
	Additional gas amount over chargeless length (g/m (oz/ft))		20 (0.2)				20 (0.2)		
Note: "●": Available									
Remarks for CU-4E24RBU 1. At least two indoor units must be connected. 2. The total nominal cooling capacity of indoor units that will be connected to outdoor unit must be within connectable capacity range of indoor unit. (as shown in the table above) Example: The indoor units' combination below is possible to connect to CU-4E24RBU. (Total nominal capacity of indoor units is between 4.5kW to 13.6kW) 1) Two CS-E9RKUAW only (Total nominal cooling capacity is 5.0kW) 2) Three CS-E12RKUAW. (Total nominal cooling capacity is 9.6kW)									

- Indoor Unit : CS-ME5RKUA, CS-ME7RKUA, CS-E9RKUAW, CS-E12RKUAW, CS-E18RKUAW, CS-E12RB4UW, CS-E18RB4UW
- Outdoor Unit : CU-3E19RBU

Indoor unit capacity	Cooling	Total	Cooling Capacity(kW)					Input Power (W)				SEER	Current, 230V (A)	MOISTURE REMOVAL VOLUME l/h
			Room A	Room B	Room C	Total	min	max	Rating	min	max			
2 Room	1.6 + 3.2	4.8	1.610	3.220		4.83	1.7	6.3	1.430	380	~	2360	6.4	1.0 + 1.8
	1.6 + 5.0	6.6	1.353	4.227		5.58	1.7	6.6	1.640	380	~	2350	6.4	0.9 + 2.4
	2.0 + 2.5	4.5	2.013	2.517		4.53	1.7	6.2	1.320	360	~	2100	7.3	1.0 + 1.5
	2.0 + 3.2	5.2	2.008	3.212		5.22	1.7	6.6	1.590	360	~	2100	7.0	1.0 + 2.5
	2.0 + 5.0	7.0	1.594	3.956		5.58	1.7	6.6	1.590	360	~	2350	7.0	1.0 + 2.5
	2.0 + 3.2 + 3.2	5.2	2.427	3.153		5.58	1.7	6.6	1.590	360	~	2360	7.2	1.5 + 1.5
	2.5 + 3.2	5.7	2.427	3.153		5.58	1.7	6.6	1.590	360	~	2350	7.0	1.5 + 1.8
	2.5 + 5.0	7.5	1.860	3.170		5.58	1.7	6.6	1.840	360	~	2350	7.0	1.2 + 2.2
	3.2 + 3.2	6.4	2.790	2.790		5.58	1.7	6.6	1.780	370	~	2350	7.0	1.4 + 1.6
3 Room	1.6 + 3.2	8.2	2.178	3.402		5.58	1.7	6.9	1.580	360	~	2350	7.0	1.4 + 2.0
	1.6 + 1.6 + 1.6	4.8	1.620	1.620	1.620	4.86	1.8	7.3	1.180	360	~	2480	5.3	1.0 + 1.0 + 1.0
	1.6 + 1.6 + 2.0	5.2	1.615	1.615	2.020	5.25	1.8	7.3	1.340	360	~	2420	6.0	1.0 + 1.0 + 1.3
	1.6 + 1.6 + 3.2	6.4	1.566	1.566	2.448	5.58	1.8	7.3	1.510	360	~	2420	6.7	1.0 + 1.0 + 1.5
	1.6 + 1.6 + 5.0	8.2	1.395	1.395	2.790	5.58	1.8	7.3	1.450	360	~	2410	6.5	0.9 + 0.9 + 1.6
	1.6 + 2.0 + 2.0	5.6	1.089	1.089	3.402	5.58	1.8	7.3	1.390	350	~	2200	6.2	0.7 + 0.7 + 2.0
	1.6 + 2.0 + 3.2	6.1	1.463	1.830	2.287	5.58	1.8	7.3	1.510	360	~	2420	6.7	1.0 + 1.3 + 1.3
	1.6 + 2.0 + 5.0	8.2	1.313	1.641	2.626	5.58	1.8	7.3	1.450	360	~	2340	6.7	0.9 + 1.2 + 1.5
	1.6 + 2.0 + 2.0 + 2.0	6.6	1.038	1.298	3.244	5.58	1.8	7.3	1.390	350	~	2200	6.5	0.8 + 1.0 + 1.6
2 Room	1.6 + 2.5 + 2.5	6.6	1.352	2.114		5.58	1.8	7.3	1.510	360	~	2420	6.7	0.9 + 1.4 + 1.4
	1.6 + 3.2 + 3.2	8.0	1.223	1.911	2.446	5.58	1.8	7.3	1.450	360	~	2340	6.5	0.8 + 1.2 + 1.5
	2.0 + 2.0 + 2.0	6.0	1.960	1.860	1.860	5.98	1.8	7.3	1.510	360	~	2420	6.7	1.2 + 1.2 + 1.4
	2.0 + 2.0 + 3.2	7.2	1.717	1.717	2.146	5.58	1.8	7.3	1.510	360	~	2420	6.7	1.1 + 1.1 + 1.4
	2.0 + 2.0 + 5.0	9.0	1.550	1.550	2.480	5.58	1.8	7.3	1.450	360	~	2340	6.5	1.0 + 1.0 + 1.5
	2.0 + 2.5 + 2.5	7.0	1.449	1.993	1.993	5.58	1.8	7.3	1.380	360	~	2130	6.2	0.8 + 0.8 + 1.7
	2.0 + 2.5 + 3.2	7.7	1.449	1.612	3.119	5.58	1.8	7.3	1.450	360	~	2420	6.5	0.8 + 1.3 + 1.3
	2.0 + 3.2 + 3.2	8.4	1.328	1.826	1.826	5.58	1.8	7.3	1.450	360	~	2370	6.5	0.8 + 1.4 + 1.2
	2.5 + 2.5 + 3.2	8.2	1.701	1.701	2.178	5.58	1.8	7.3	1.450	360	~	2340	6.5	1.1 + 1.1 + 1.4
2.5 + 3.2 + 3.2	8.9	1.588	2.006	2.006	5.58	1.8	7.3	1.450	350	~	2270	6.5	1.0 + 1.3 + 1.3	

Indoor unit capacity	Cooling	Total	Cooling Capacity(BTU/hr)					Input Power (W)				SEER	Current, 230V (A)	MOISTURE REMOVAL VOLUME l/h
			Room A	Room B	Room C	Total	min	max	Rating	min	max			
2 Room	1.6 + 3.2	4.8	5500	11000		16500	5900	~	21400	1430	~	2360	6.4	1.0 + 1.8
	1.6 + 5.0	6.6	4606	14384		15400	5900	~	23200	1640	~	2350	7.3	0.9 + 2.4
	2.0 + 2.5	4.5	6844	8556		17600	5900	~	21400	1320	~	2100	5.9	1.3 + 1.5
	2.0 + 3.2	5.2	6846	10954		19000	5900	~	23200	1580	~	2350	7.0	1.0 + 2.3
	2.0 + 5.0	7.0	5429	13571		17200	5900	~	21200	1610	~	2360	7.2	1.5 + 1.5
	2.5 + 3.2	5.7	8333	10667		19000	5900	~	23200	1580	~	2350	7.0	1.5 + 1.8
	2.5 + 5.0	7.5	6333	12667		19000	5900	~	21800	1780	~	2360	7.0	1.2 + 2.2
	3.2 + 3.2	6.4	9500	9500		19000	5900	~	21800	1780	~	2350	7.9	1.6 + 1.6
	3.2 + 5.0	8.2	7415	11585		19000	5900	~	23600	1580	~	2350	7.0	1.4 + 2.0
3 Room	1.6 + 1.6 + 1.6	4.8	5533	5533	5533	16500	6100	~	24800	1180	~	2490	5.3	1.0 + 1.0 + 1.0
	1.6 + 1.6 + 2.0	5.2	5508	5508	6894	17900	6100	~	24800	1340	~	2420	6.0	1.0 + 1.0 + 1.3
	1.6 + 1.6 + 3.2	6.4	5333	5333	6834	16000	6100	~	24800	1410	~	2410	6.5	0.9 + 0.9 + 1.6
	1.6 + 1.6 + 5.0	8.2	4759	3759	11596	19000	6100	~	24800	1510	~	2200	6.2	0.7 + 0.7 + 2.0
	1.6 + 2.0 + 2.0	5.6	5428	6786	7787	19000	6100	~	24800	1510	~	2420	6.7	1.0 + 1.3 + 1.3
	1.6 + 2.0 + 3.2	6.1	4983	6230	7787	19000	6100	~	24800	1510	~	2420	6.7	1.0 + 1.3 + 1.3
	1.6 + 2.0 + 5.0	8.6	3534	4419	11047	19000	6100	~	24800	1390	~	2200	6.5	0.9 + 1.2 + 1.5
	1.6 + 2.5 + 2.5	6.6	4626	7197	7197	19000	6100	~	24800	1510	~	2200	6.2	0.7 + 0.8 + 1.8
	1.6 + 2.5 + 3.2	7.3	4184	6507	8329	19000	6100	~	24800	1450	~	2200	6.7	0.9 + 1.4 + 1.4
2 Room	1.6 + 3.2 + 3.2	8.0	3800	7600	6333	19000	6100	~	24800	1450	~	2200	6.5	0.8 + 1.2 + 1.5
	2.0 + 2.0 + 2.0	6.0	6333	6333	7308	19000	6100	~	24800	1510	~	2420	6.5	0.7 + 1.5 + 1.5
	2.0 + 2.0 + 2.5	6.5	5846	5846	7308	19000	6100	~	24800	1510	~	2420	6.7	1.1 + 1.1 + 1.4
	2.0 + 2.0 + 3.2	7.2	5278	4278	8444	19000	6100	~	24800	1450	~	2340	6.5	1.0 + 1.0 + 1.5
	2.0 + 2.0 + 5.0	9.0	4222	10556	6786	19000	6100	~	24800	1390	~	2200	6.2	0.8 + 0.8 + 1.7
	2.0 + 2.5 + 2.5	7.0	5428	6786	7786	19000	6100	~	24800	1510	~	2420	6.7	1.0 + 1.3 + 1.3
	2.0 + 2.5 + 3.2	7.7	4985	6169	7686	19000	6100	~	24800	1450	~	2340	6.5	0.9 + 1.2 + 1.5
	2.0 + 3.2 + 3.2	8.4	4524	7238	7238	19000	6100	~	24800	1450	~	2270	6.5	0.8 + 1.4 + 1.4
	2.5 + 2.5 + 2.5	7.5	6333	6333	7333	19000	6100	~	24800	1510	~	2420	6.7	1.2 + 1.2 + 1.2
2.5 + 2.5 + 3.2	8.2	5793	5793	7414	19000	6100	~	24800	1450	~	2340	6.5	1.1 + 1.1 + 1.4	
2.5 + 3.2 + 3.2	8.9	5330	6531	6531	19000	6100	~	24600	1450	~	2270	6.5	1.0 + 1.3 + 1.3	

3. Dimensions

3.1 CU-3E19RBU

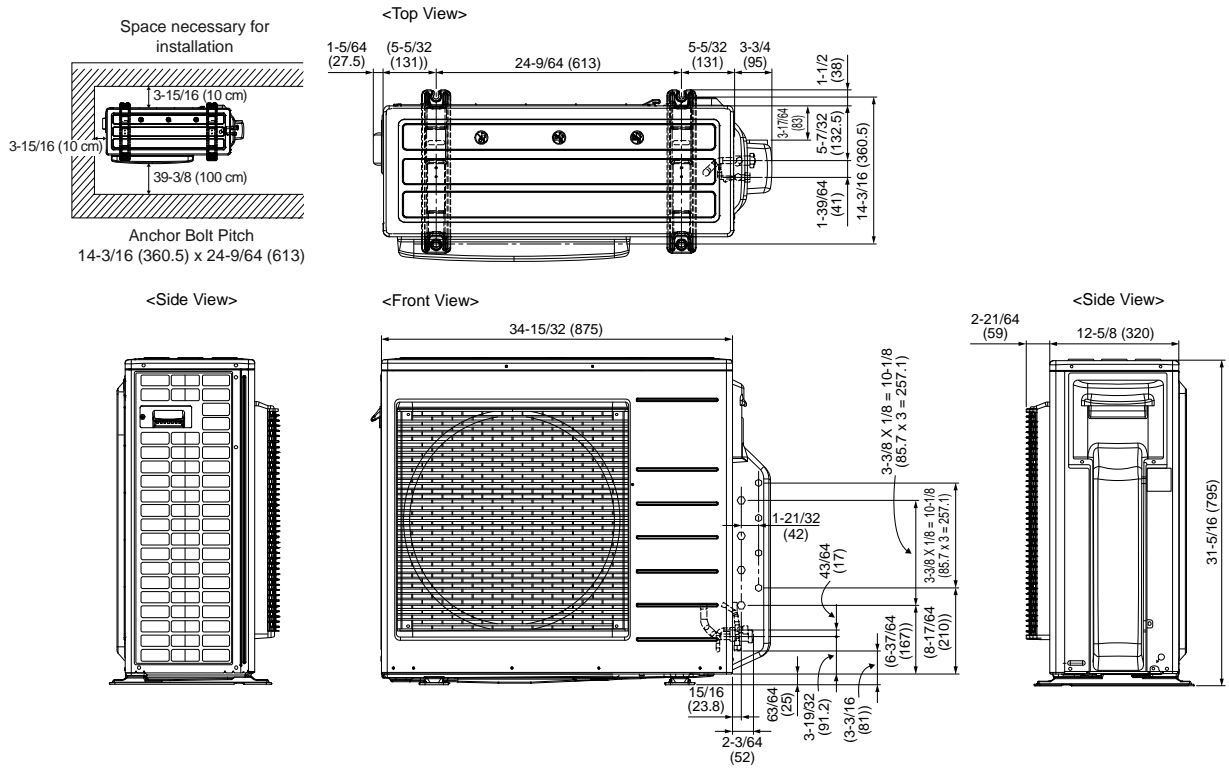

3.2 CU-4E24RBU

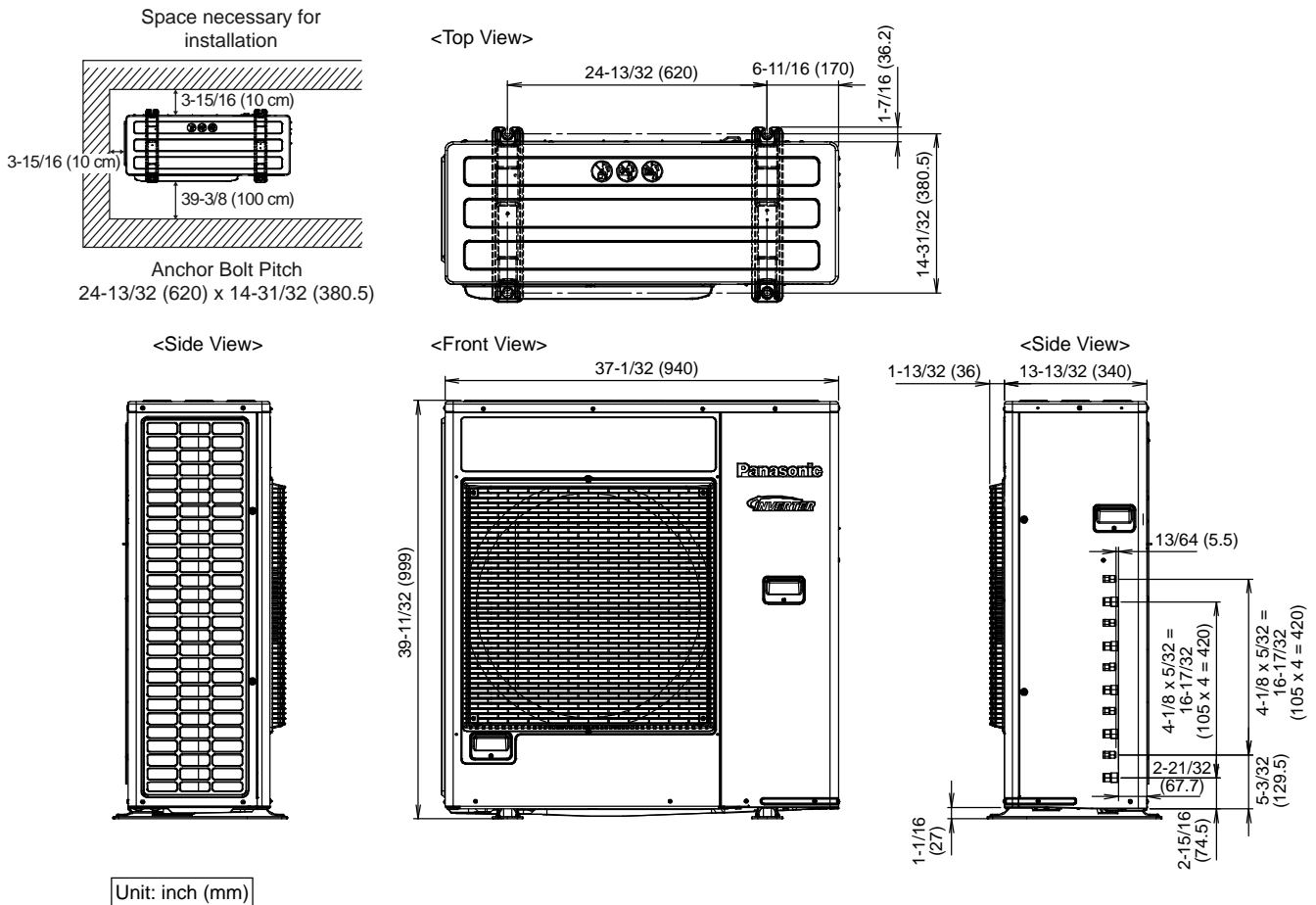

4. Refrigeration Cycle Diagram

4.1 CU-3E19RB

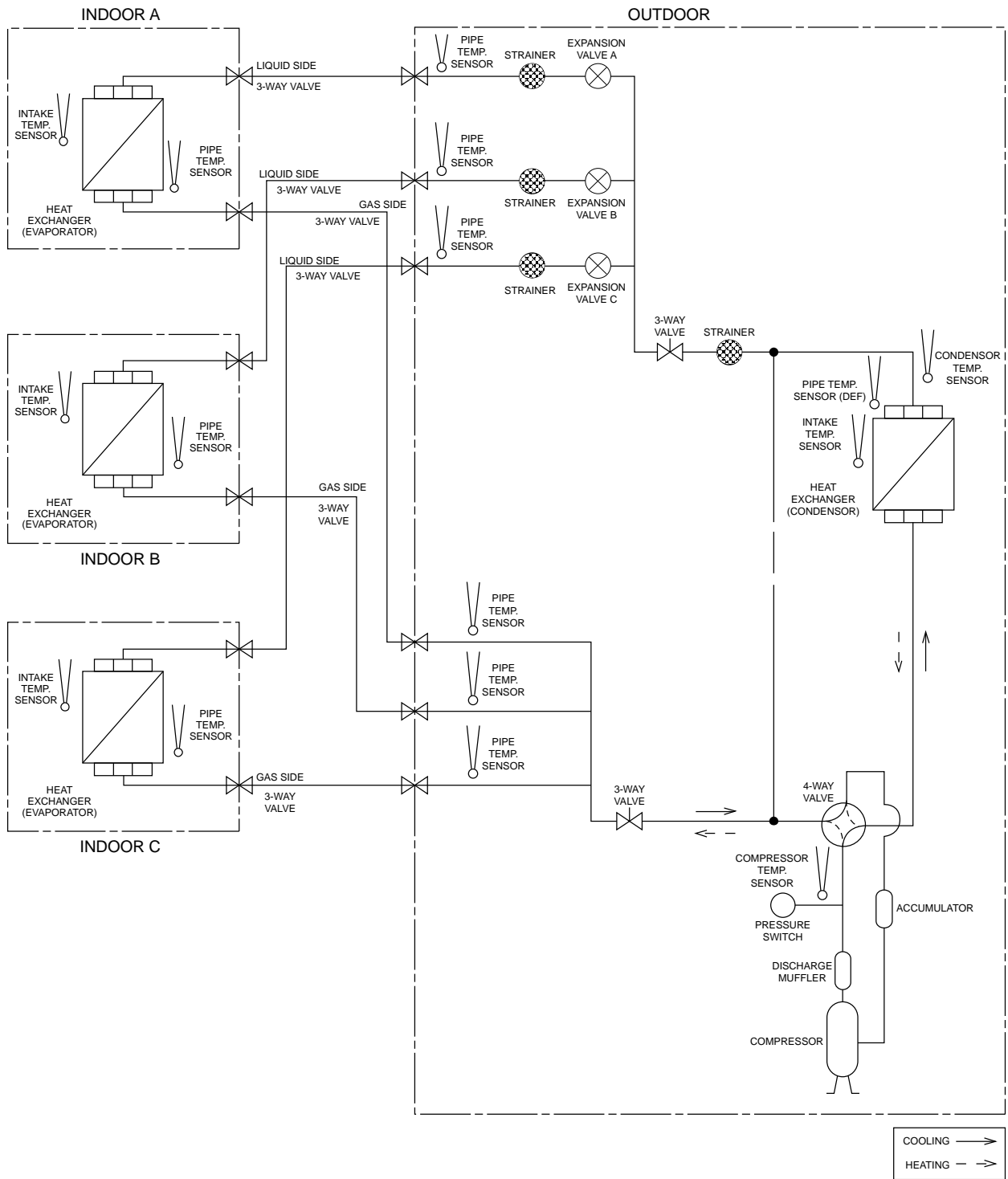

4.2 CU-4E24RBU

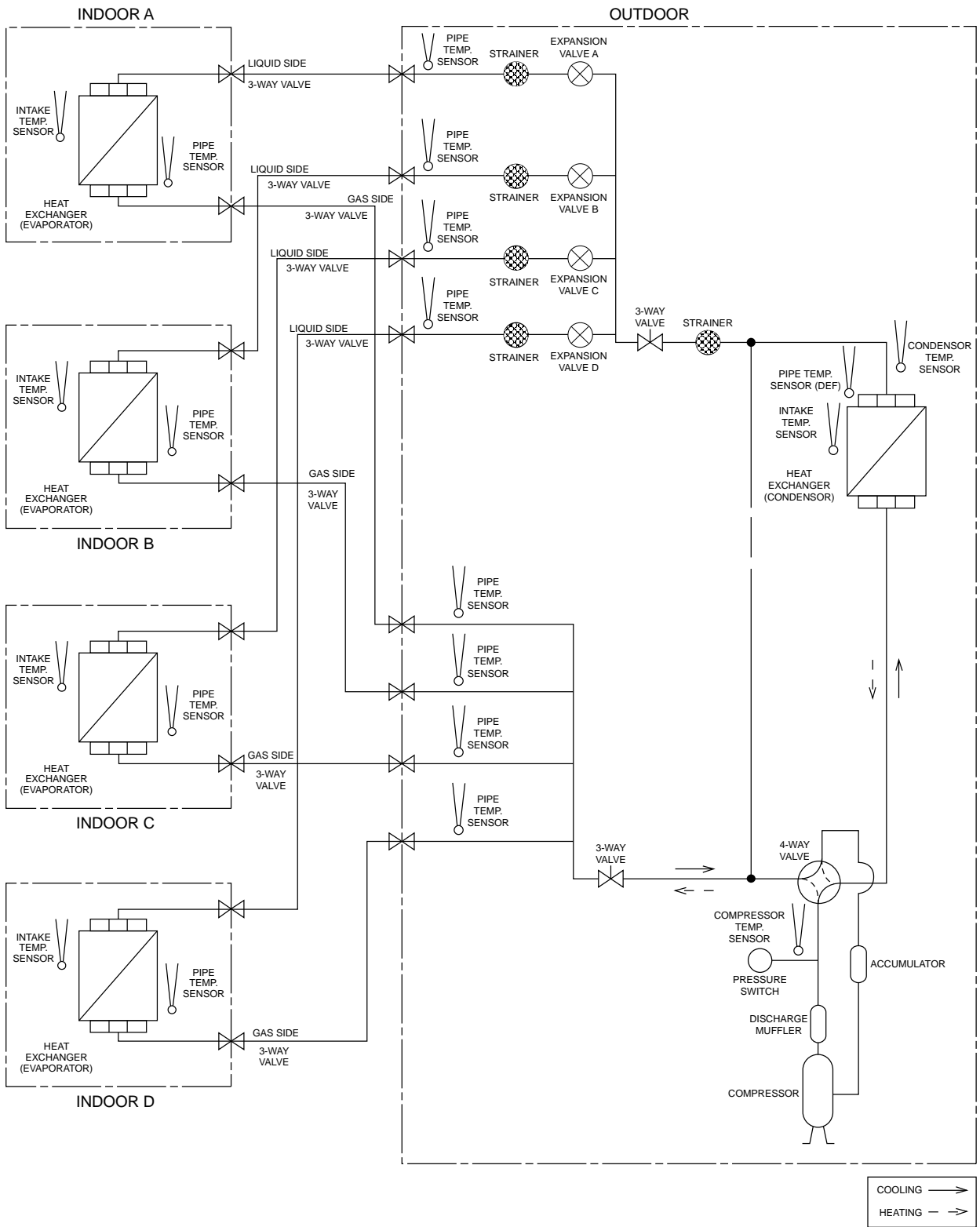

5. Block Diagram

5.1 CU-3E19RBU

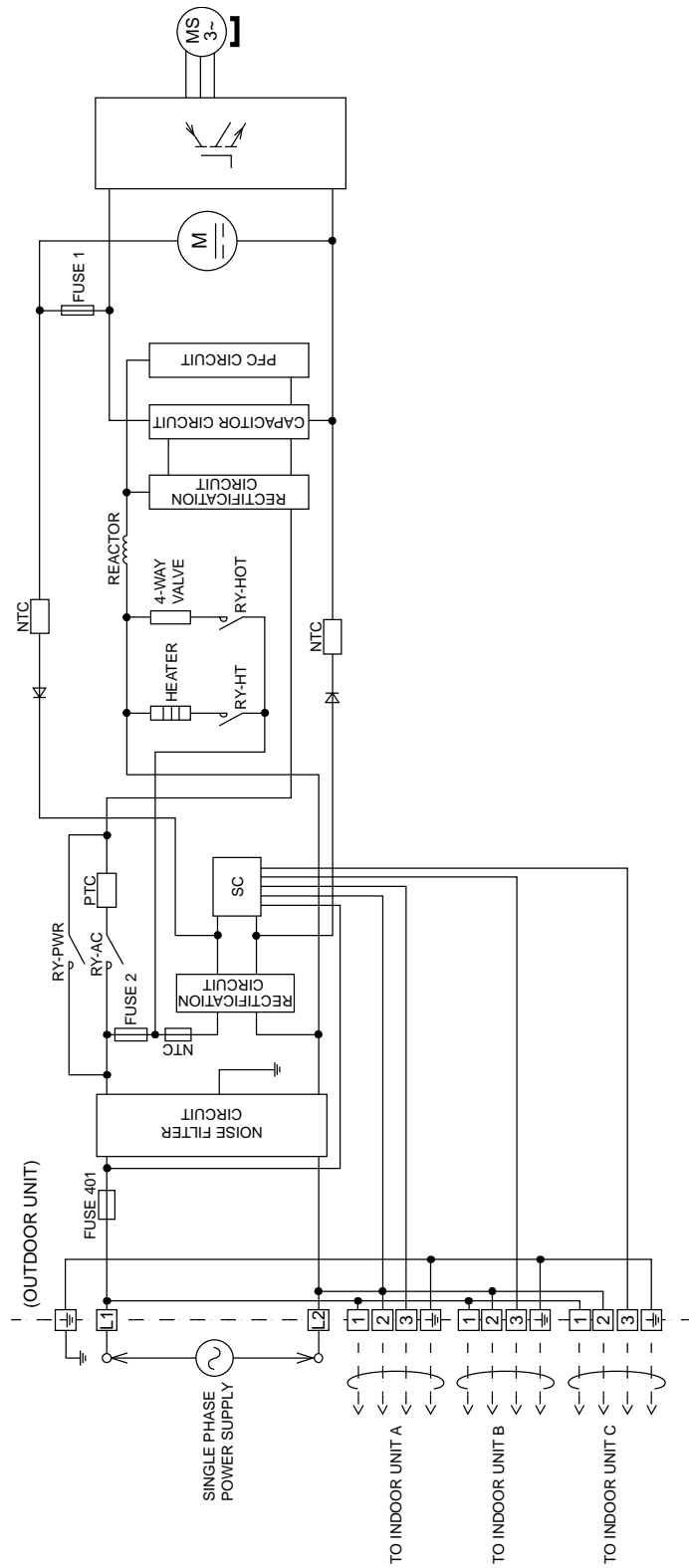

5.2 CU-4E24RBU

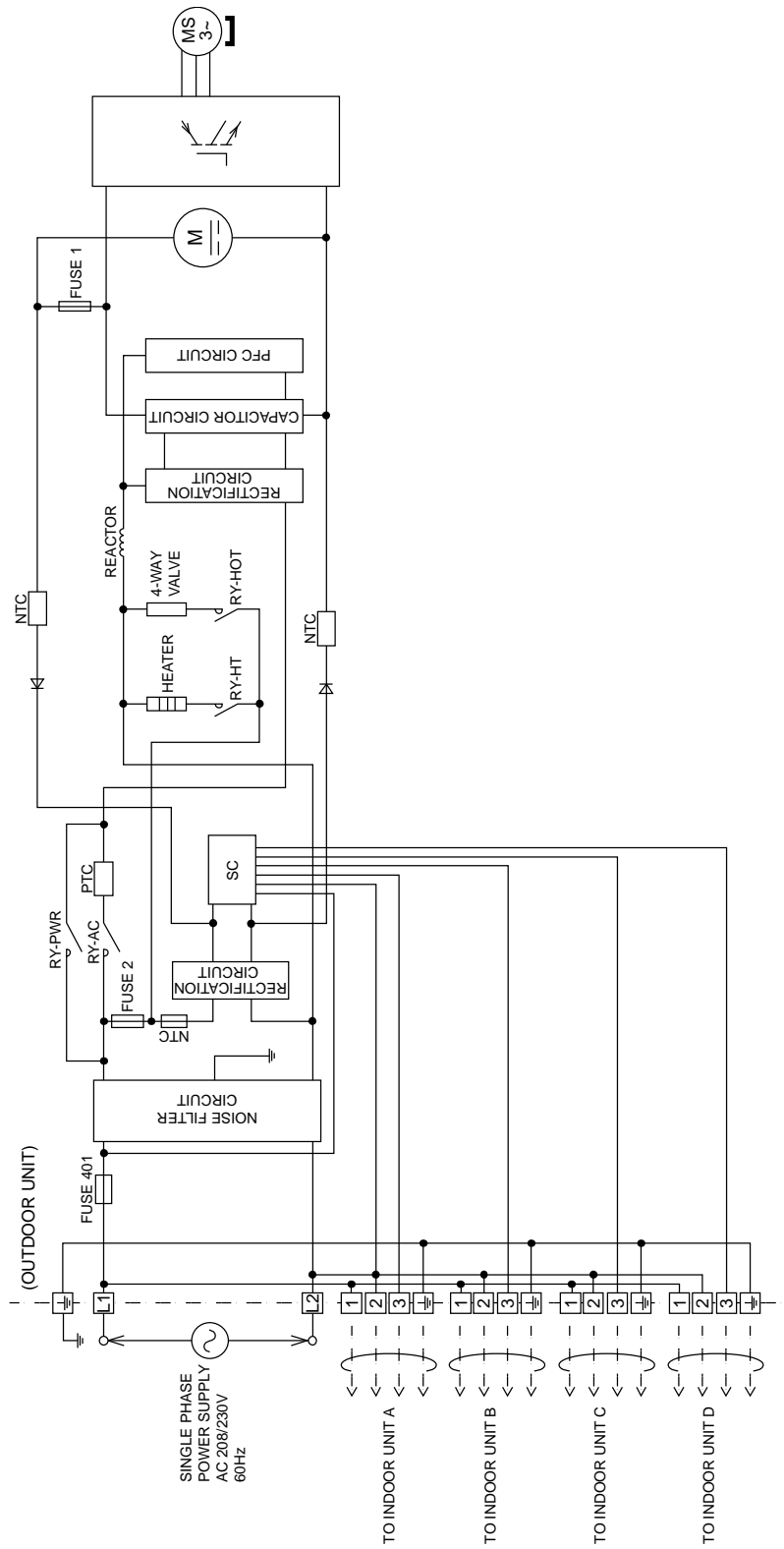

6. Wiring Connection Diagram

6.1 CU-3E19RBU

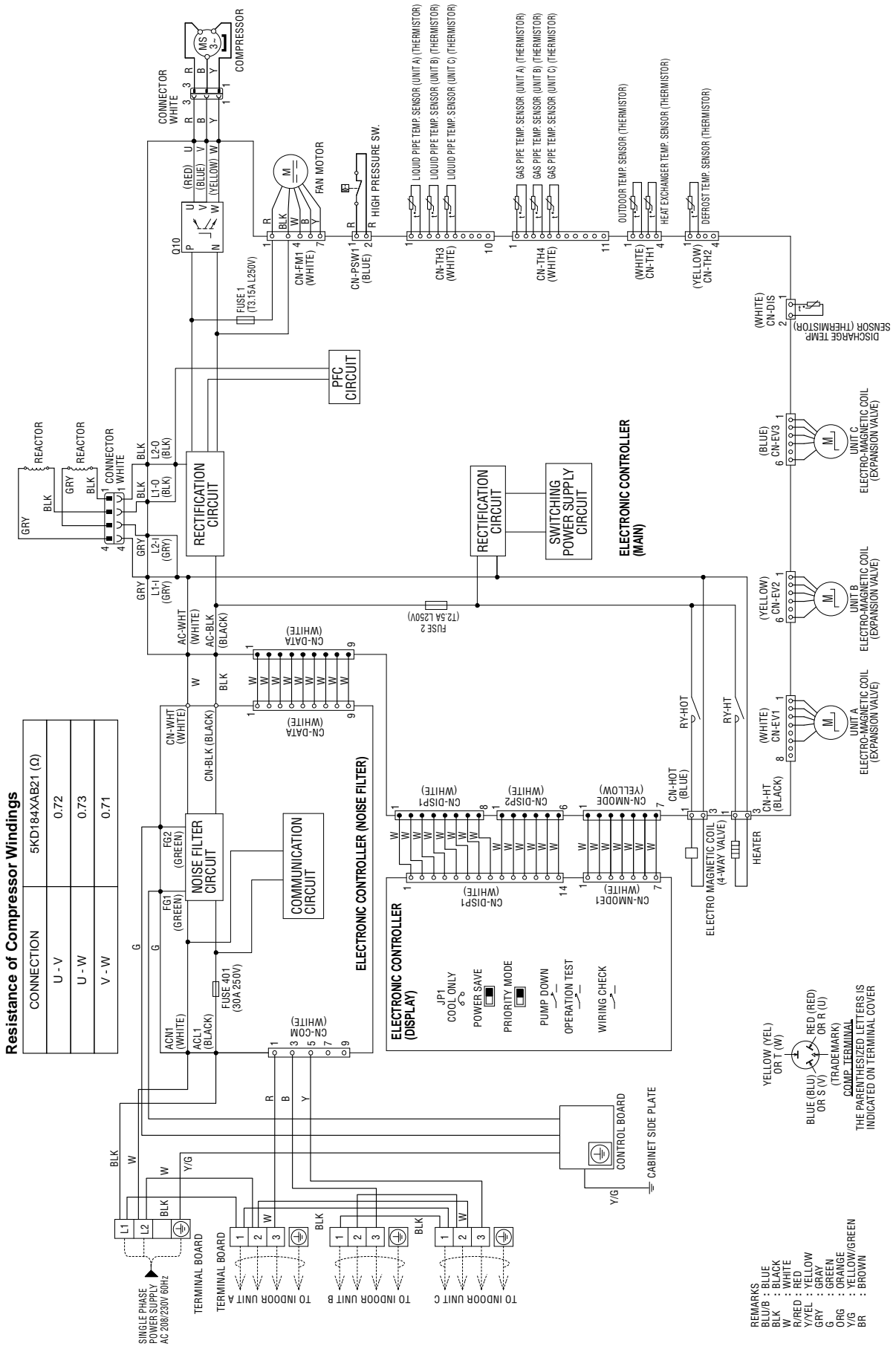

6.2 CU-4E24RBU

Resistance of Compressor Windings

CONNECTION	5KD240XAL21 (Ω)
U - V	0.72
U - W	0.73
V - W	0.71

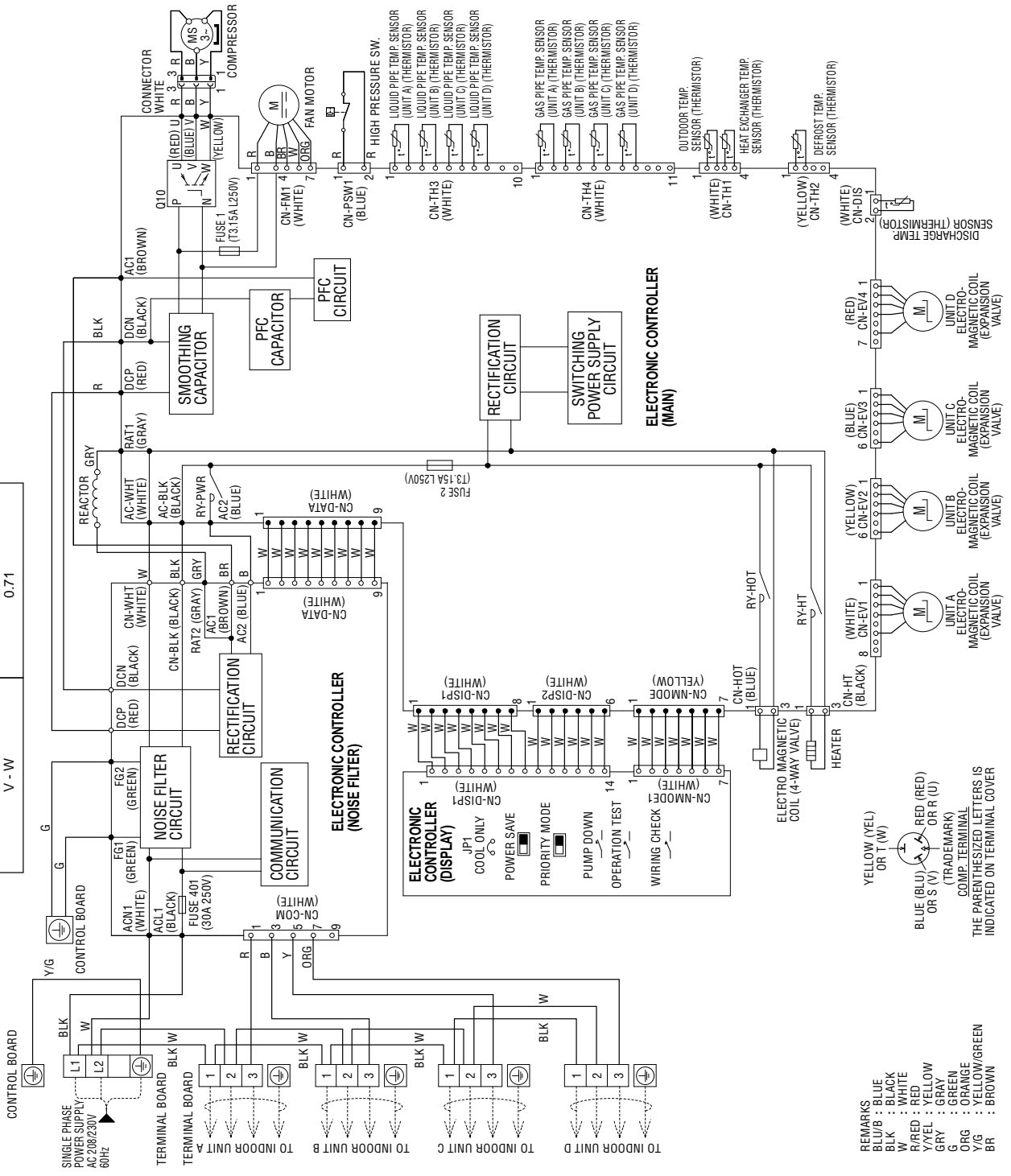

7. Electronic Circuit Diagram

7.1 CU-3E19RBU

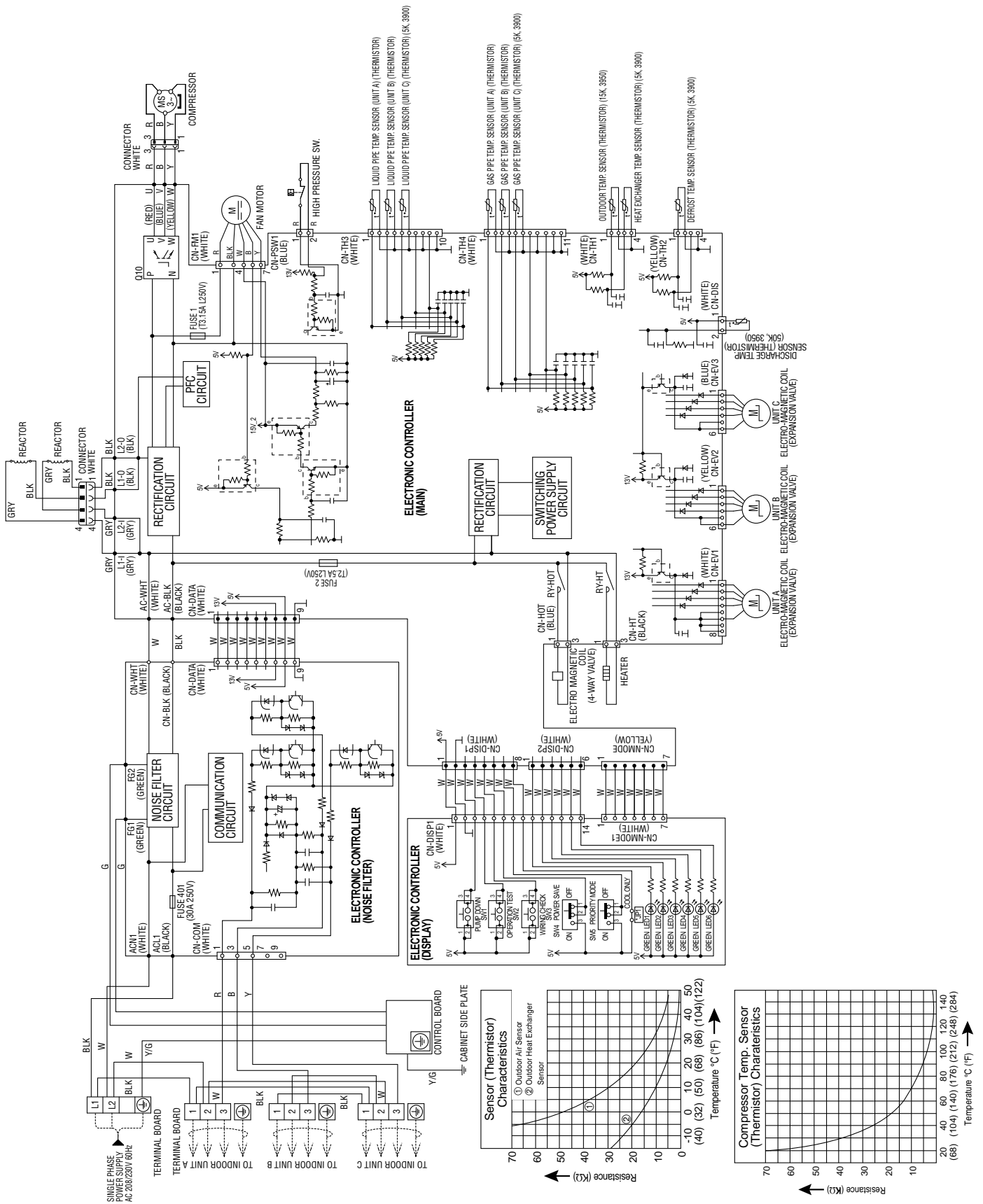

7.2 CU-4E24RB

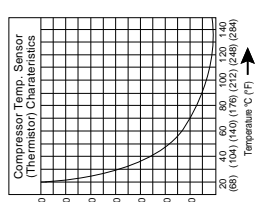
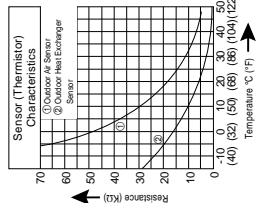
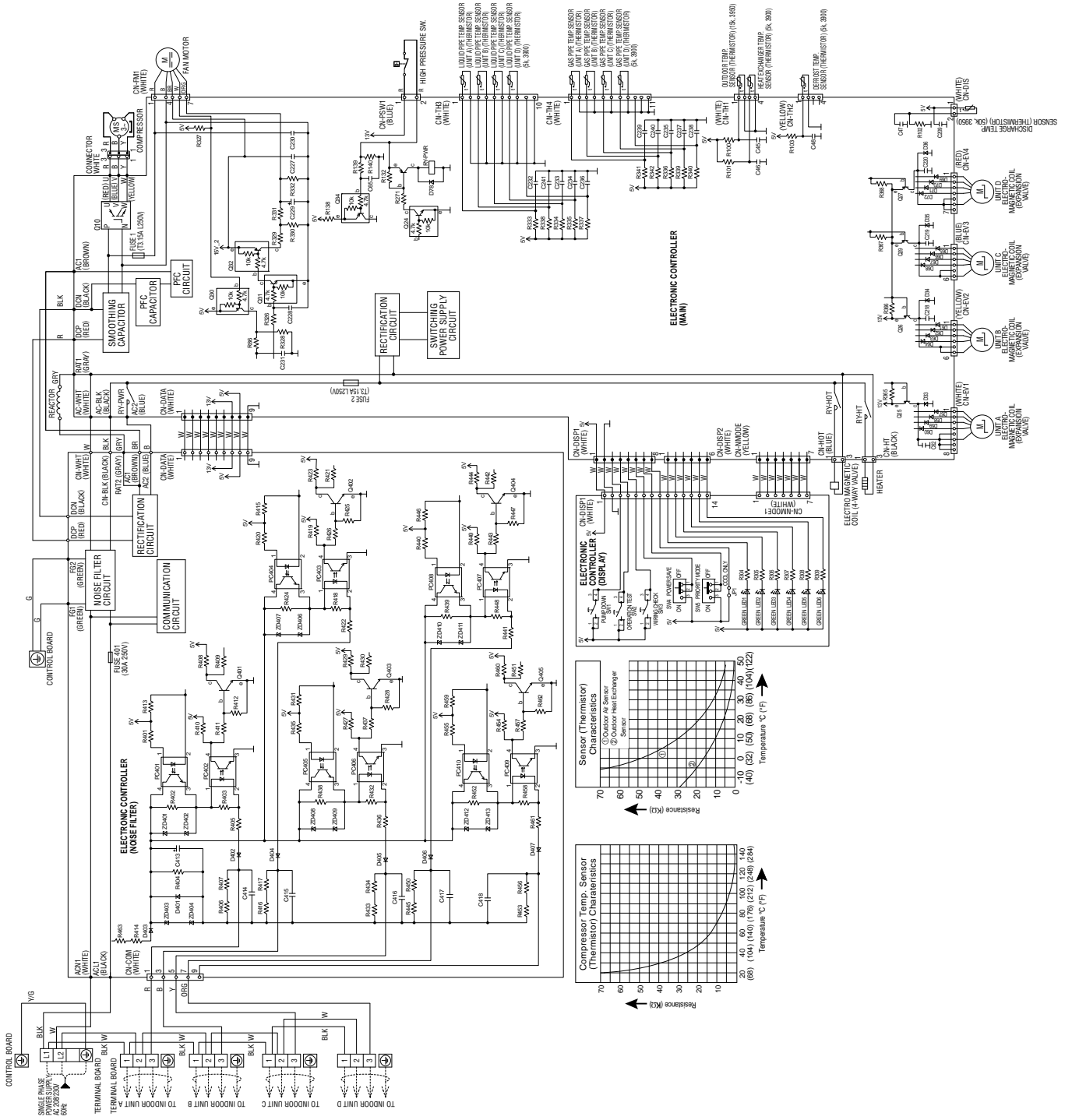

8. Printed Circuit Board

8.1 Main Printed Circuit Board

8.1.1 CU-3E19RBU

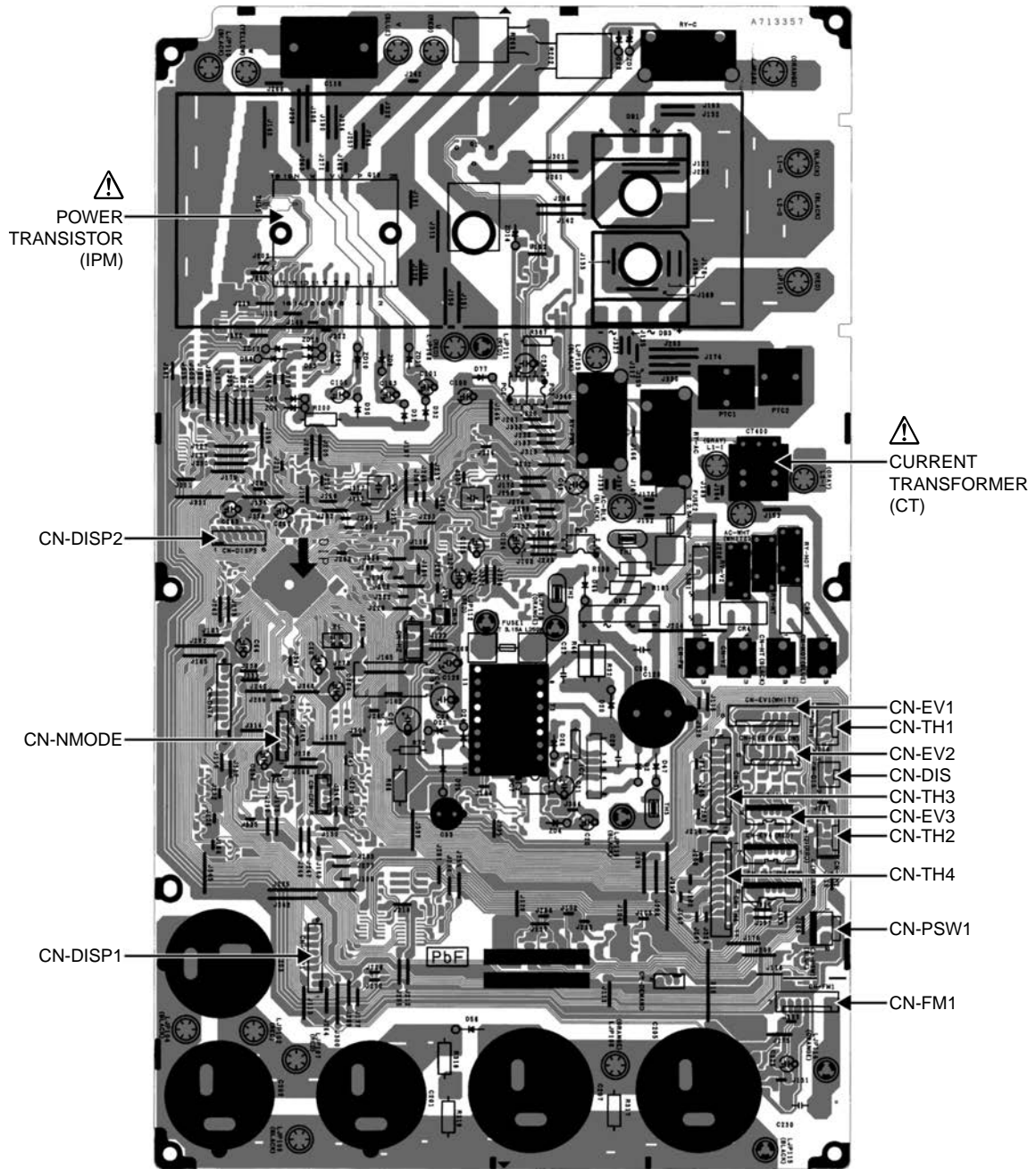

8.1.2 CU-4E24RBU

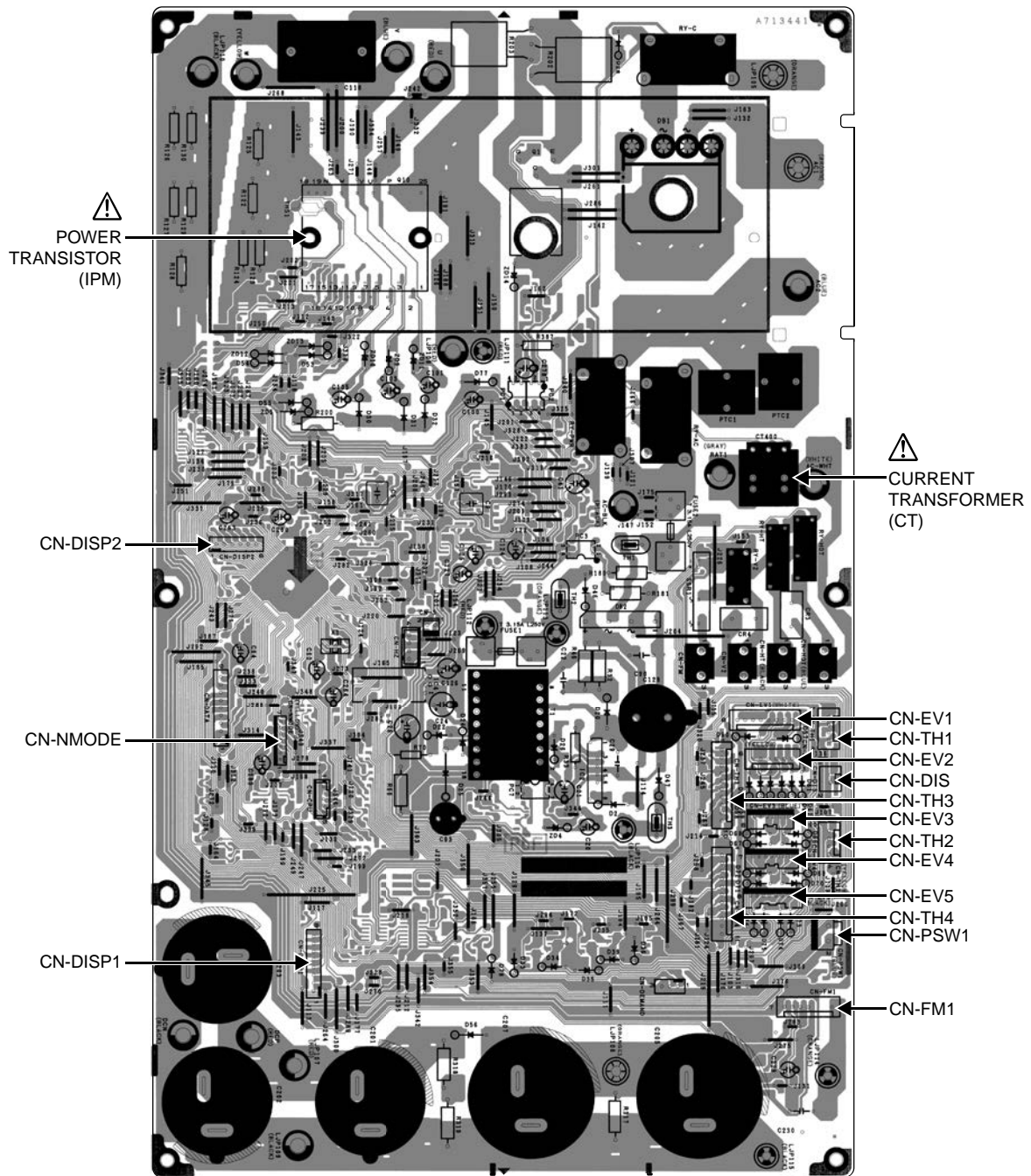

8.2 Noise Filter Printed Circuit Board

8.2.1 CU-3E19RB

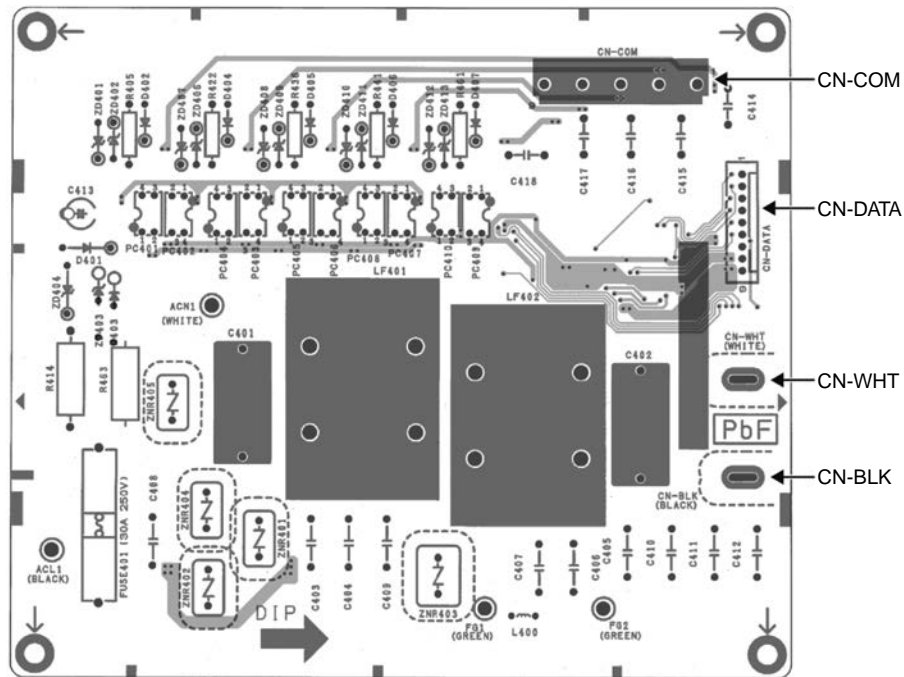

8.2.2 CU-4E24RB

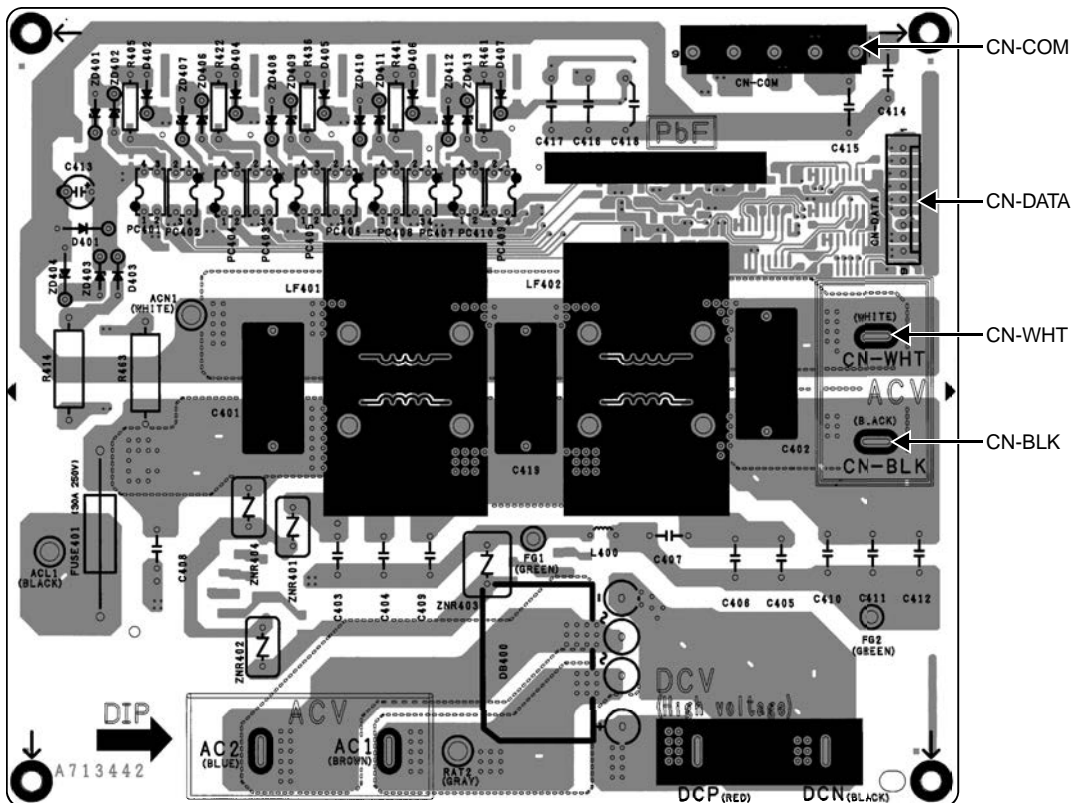

8.3 Display Printed Circuit Board

8.3.1 CU-3E19RBU

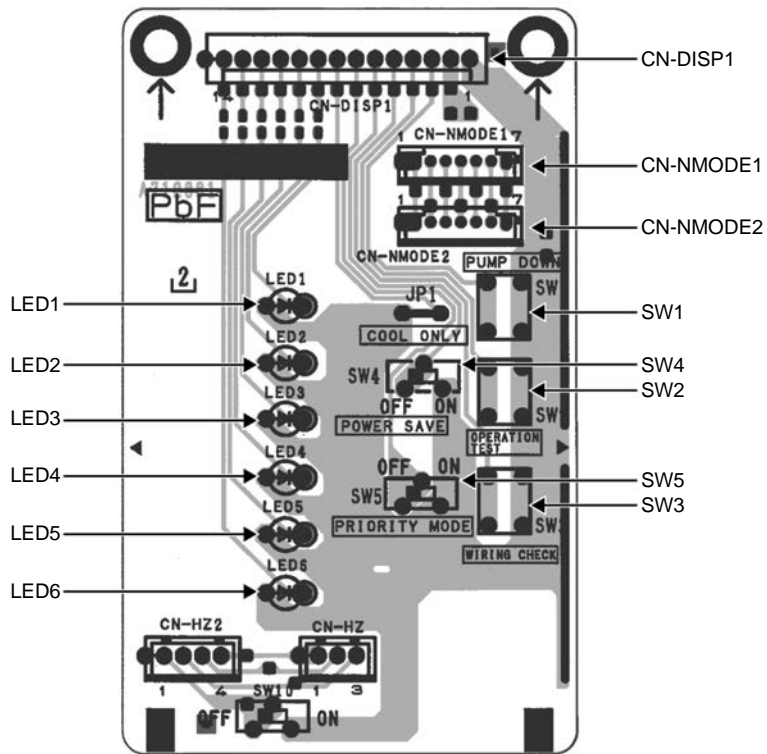

8.3.2 CU-4E24RBU

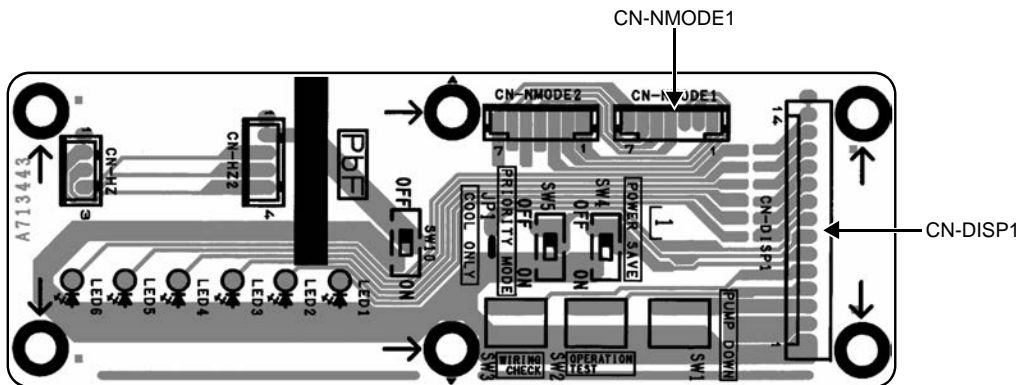

9. Installation Information

9.1 CU-3E19RBU

9.1.1 Check Points

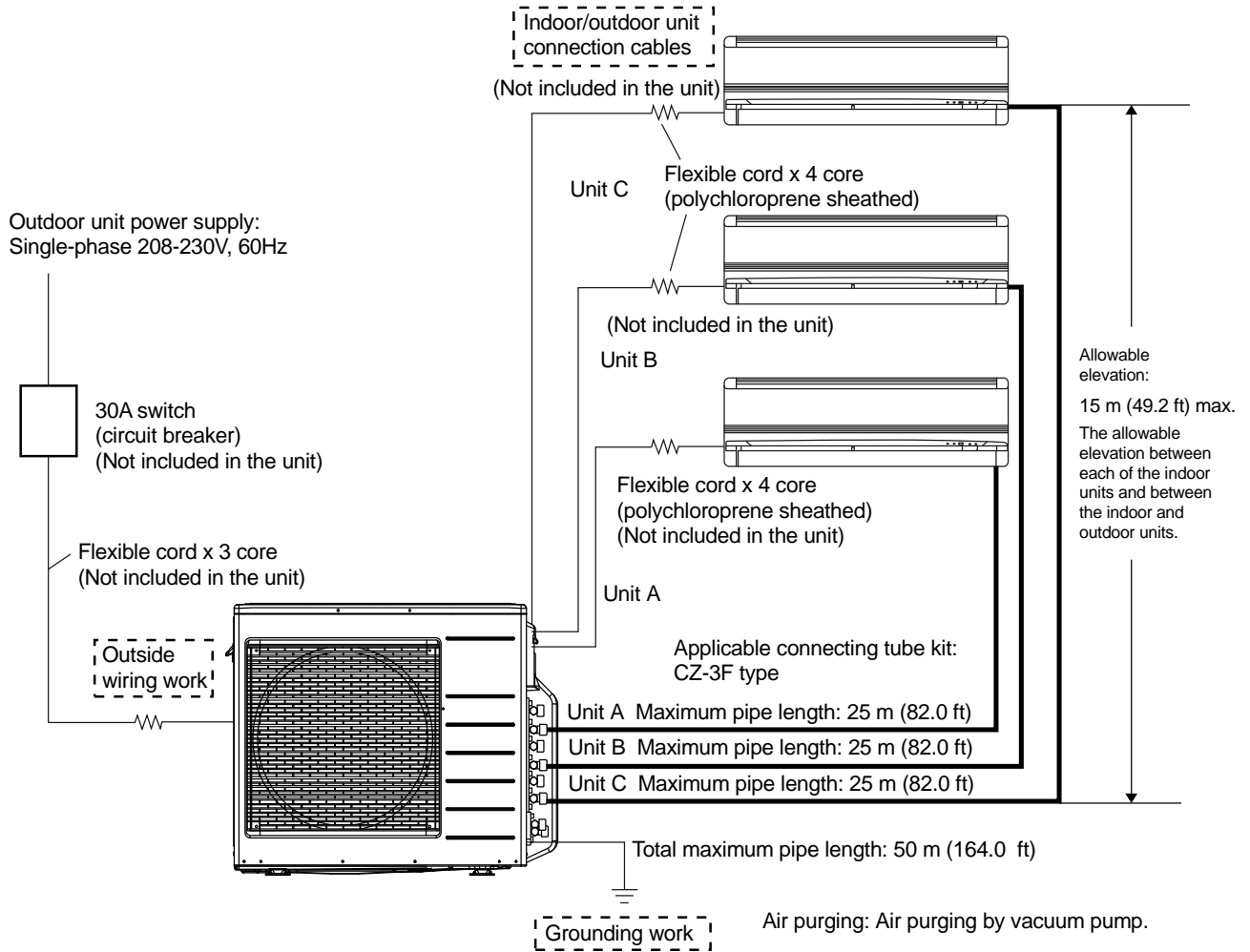

9.2 CU-4E24RBU

9.2.1 Check Points

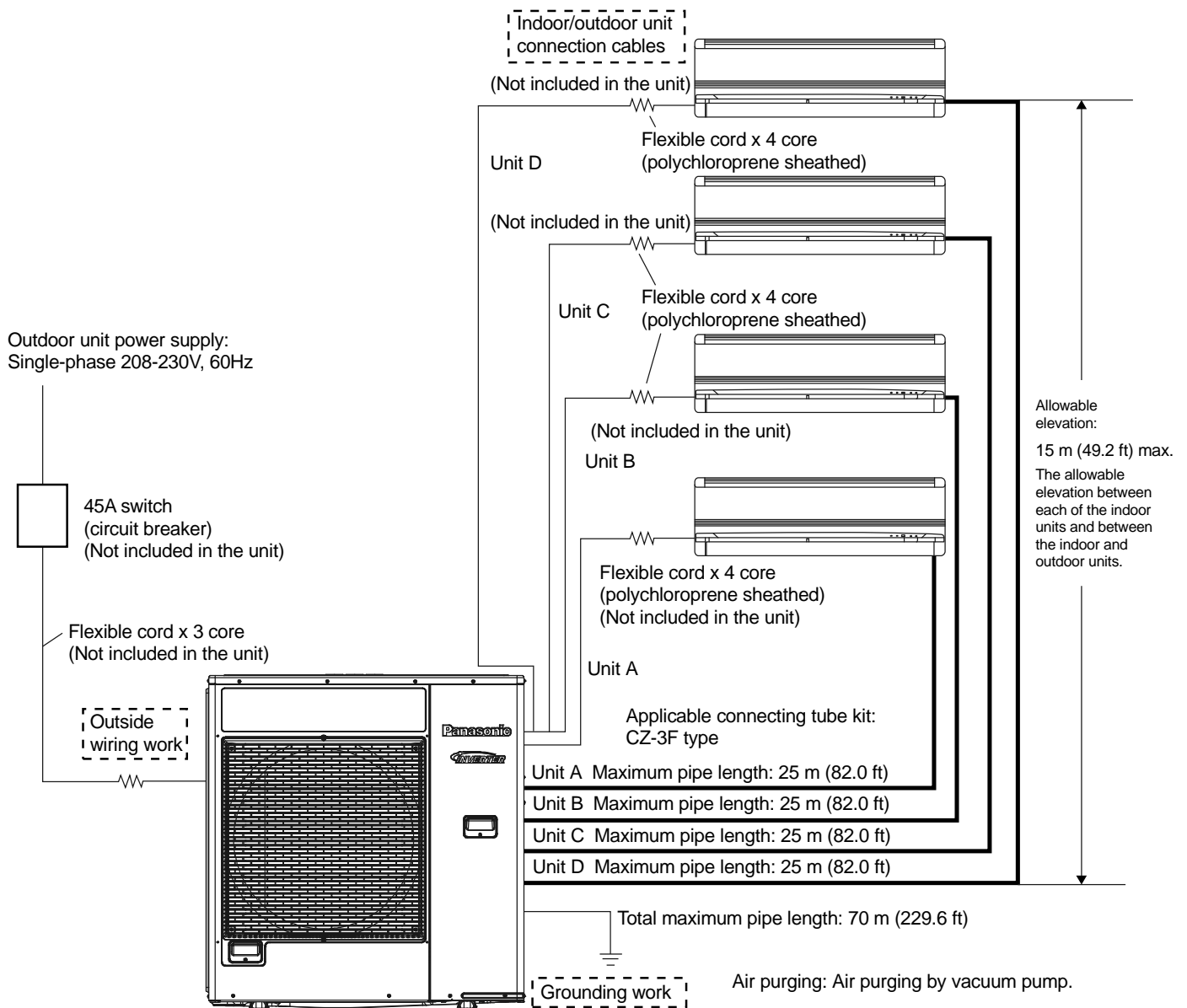

10. Installation Instruction

10.1 CU-3E19RBU

10.1.1 Select The Best Location

- If an awning is built over the unit to prevent direct sunlight or rain, be careful that heat radiation from the condenser is not obstructed.
- There should not be any animal or plant which could be affected by hot air discharged.
- Keep the spaces indicated by arrows from wall, ceiling, fence or other obstacles.
- Do not place any obstacles which may cause a short circuit of the discharged air.
- Recommended installation height for outdoor unit should be above the seasonal snow level.

Refrigerant piping size	
Outdoor Unit	CU-3E19**
Liquid - side	ø1/4" (ø6.35 mm) thickness 1/32" (t0.8 mm)
Gas - side	ø3/8" (ø9.52 mm) thickness 1/32" (t0.8 mm)

Outdoor Unit	CU-3E19**
Min. total piping length for additional gas	98.4 ft (30 m)

- If total piping length of all indoor units exceeds the minimum length listed above, additionally charge with 0.2 oz (20g) of refrigerant (R410A) for each additional feet (meter) of piping.

10.1.1.1 Outdoor Unit Installation Diagram

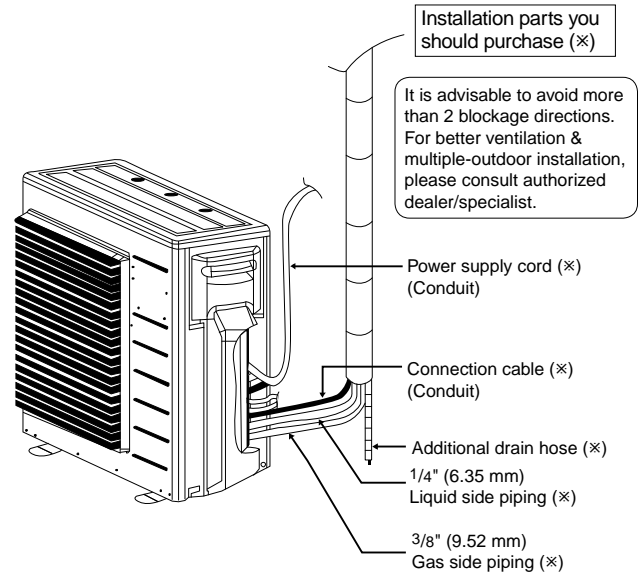

- This illustration is for explanation purposes only.
- * Note:
Respective indoor unit installation procedure shall refer to instruction manual provided in the indoor unit packaging.

Allowable piping length			
Outdoor Unit			CU-3E19***
Allowable piping length of each indoor unit (min. ~ max.)			9.8 ft ~ 82.0 ft (3 m ~ 25 m)
Allowable total piping length of all indoor unit			164.0 ft (50 m) or less
Height difference between indoor and outdoor unit	Outdoor unit located on upper side	Ⓐ	49.2 ft (15 m) or less
	Outdoor unit located otherwise	Ⓑ	24.6 ft (7.5 m) or less
	Outdoor unit located otherwise	Ⓒ	49.2 ft (15 m) or less
Height difference between indoor unit	Outdoor unit located on upper side	Ⓓ	24.6 ft (7.5 m) or less
	Outdoor unit located otherwise	Ⓔ	49.2 ft (15 m) or less

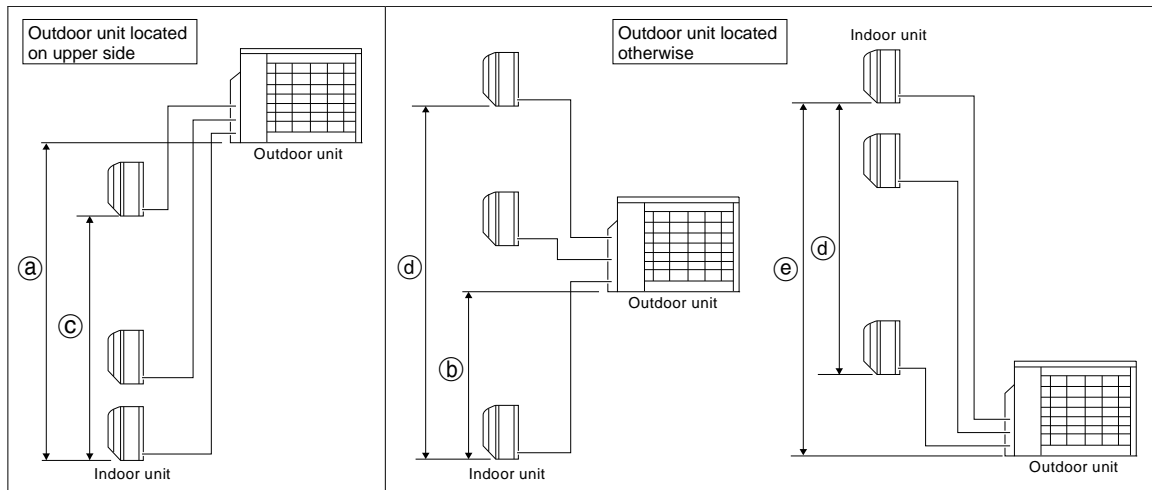

Outdoor Unit Installation Guidelines

- Where a wall or other obstacle is in the path of outdoor unit's intake or exhaust airflow, follow the installation guidelines below.
- For any of the below installation patterns, the wall height on the exhaust side should be 47-1/4" (1200 mm) or less.

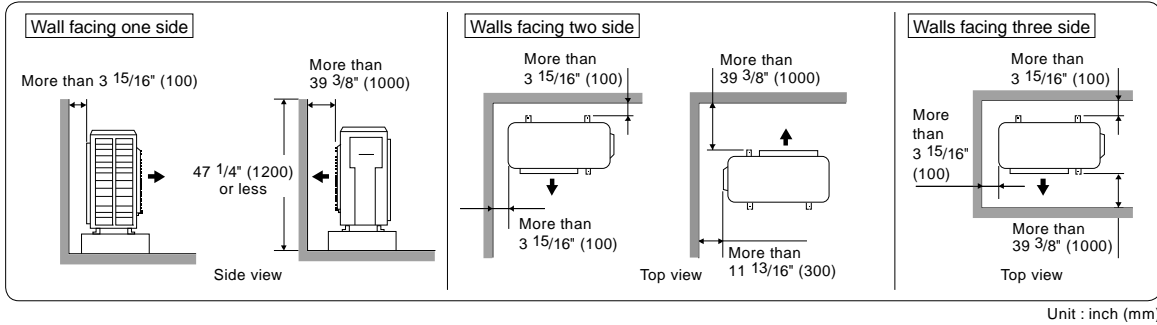

Unit : inch (mm)

10.1.2 Install The Outdoor Unit

- After selecting the best location, start installation to Indoor/Outdoor Unit Installation Diagram.
 1. Fix the unit on concrete or rigid frame firmly and horizontally by bolt nut ($\phi 13/32$ " ($\phi 10$ mm)).
 2. When installing on a roof, please consider strong winds and earthquakes.
 3. Please fasten the installation stand firmly with bolt or nails.

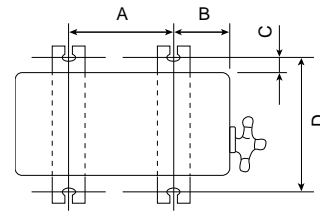

Model	A	B	C	D
CU-3E19***	24-1/8" (613 mm)	5-5/32" (131 mm)	5/8" (16 mm)	14-3/16" (360.5 mm)

10.1.3 Connect The Piping

- Remove the control board cover (resin) from the outdoor unit by loosening three screws.

Connecting The Piping To Outdoor Unit

Decide piping length and then cut by using pipe cutter. Remove burrs from cut edge. Make flare after inserting the flare nut (locate at valve) onto the copper pipe. Align center of piping to valves and then tighten with torque wrench to the specified torque as stated in the table.

Do not over tighten, over tightening may cause gas leakage	
Piping size	Torque
1/4" [6.35 mm]	13.3 lbf•ft [18 N•m (1.8 kgf•m)]
3/8" [9.52 mm]	31.0 lbf•ft [42 N•m (4.3 kgf•m)]
1/2" [12.7 mm]	40.6 lbf•ft [55 N•m (5.6 kgf•m)]
5/8" [15.88 mm]	47.9 lbf•ft [65 N•m (6.6 kgf•m)]
3/4" [19.05 mm]	73.8 lbf•ft [100 N•m (10.2 kgf•m)]

Gas Leak Checking

Pressure test to system to 400 PSIG with dry nitrogen, in stages. Thoroughly leak check the system. If the pressure holds, release the nitrogen and proceed to section 10.1.4.

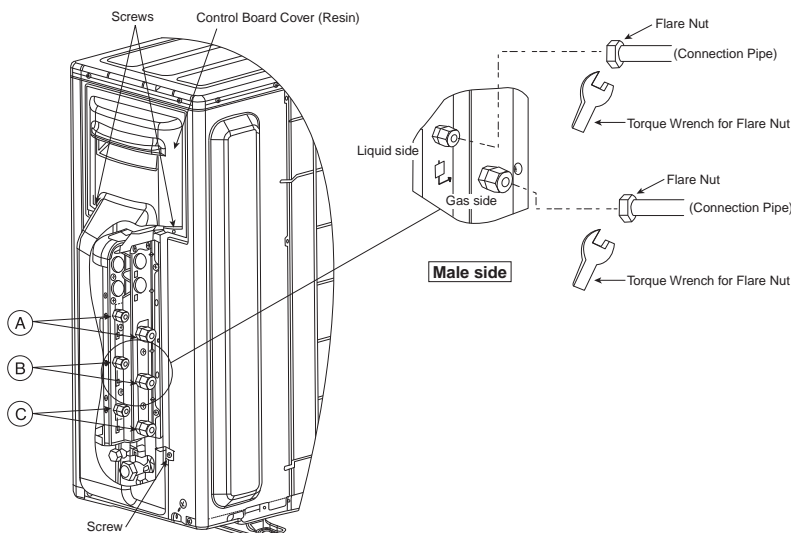

Female side

Applicable to
Liquid and Gas side of
CS-ME5*** CS-E12***
CS-ME7*** CS-E18***
CS-E9***

CUTTING AND FLARING THE PIPING

1. Please cut using pipe cutter and then remove the burrs.
2. Remove the burrs by using reamer. If burrs is not removed, gas leakage may be caused. Turn the piping end down to avoid the metal powder entering the pipe.
3. Please make flare after inserting the flare nut onto the copper pipes.

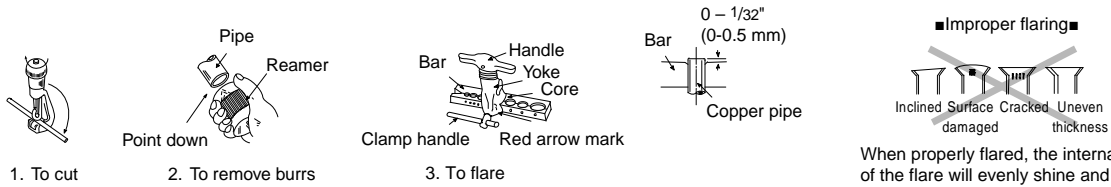

When properly flared, the internal surface of the flare will evenly shine and be of even thickness. Since the flare part comes into contact with the connections, carefully check the flare finish.

10.1.4 Evacuation Of The Equipment

WHEN INSTALLING AN AIR CONDITIONER, BE SURE TO EVACUATE THE AIR INSIDE THE INDOOR UNIT AND PIPES in the following procedure.

1. Connect a charging hose with a push pin to the Low side of a charging set and the service port of the gas side 3-way valve.
2. Connect the micron gauge between vacuum pump and service port of outdoor units.
3. Turn on the power switch of the vacuum pump and make sure that connect digital micron gauge and to pull down to a value of 500 microns.
4. To make sure micron gauge a value 500 microns and close the low side valve of the charging set and turn off the vacuum pump.
5. Disconnect the vacuum pump house from the service port of the 3-way valve.
6. Tighten the service port caps of gas side 3-way valve at a torque of 13.3 lbf•ft (18 N•m) with a torque wrench.
7. Remove the valve caps of both of the 2-way valve and 3-way valve. Position both of the valves to "Open" using a hexagonal wrench (5/32" (4 mm)).
8. Mount valve caps onto the 2-way valve and 3-way valve.
 - o Be sure to check for gas leakage.

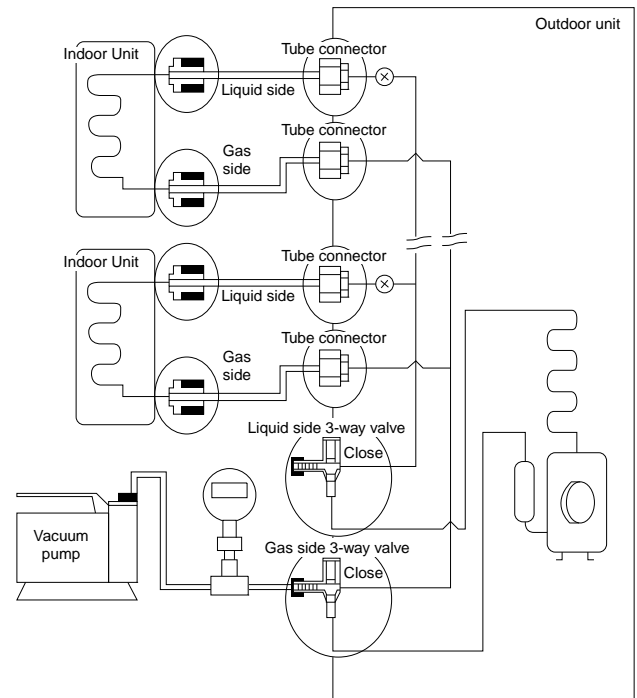

CAUTION

- If micron gauge value does not descend 500 microns, take the following measures:
 - If the leak stops when the piping connections are tightened further, continue working from step ③.
 - If the leak does not stop when the connections are retightened, repair location of leak.
 - Do not release refrigerant during piping work for installation and reinstallation.
 - Take care when handling the liquid refrigerant, it may cause frostbite.

10.1.5 Connect The Cable To The Outdoor Unit

1. Remove Control Board Cover (Metal) by loosening 2 screws.
2. Remove Valve Cover (Metal) by loosening 2 screws.
3. Remove Plugs.
4. Fix the conduit connectors to the knock out holes with lock-nuts, then secure them.
5. Connecting wire between indoor unit and outdoor unit should be UL listed or CSA approved 4 conductor wires minimum AWG16 in accordance with local electric codes.
6. Wire Connection to the power supply (208/230V 60Hz) through circuit breaker.
 - Connect the UL listed or CSA approved wires minimum AWG12 to the terminal board, and connect to other end of the wires to circuit breaker.
7. Connect the power supply cord and connecting wires between indoor unit and outdoor unit according to the diagram as shown.

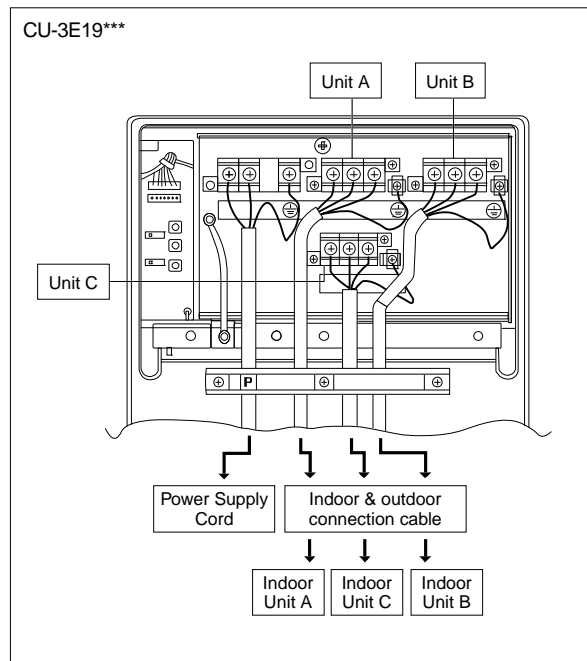
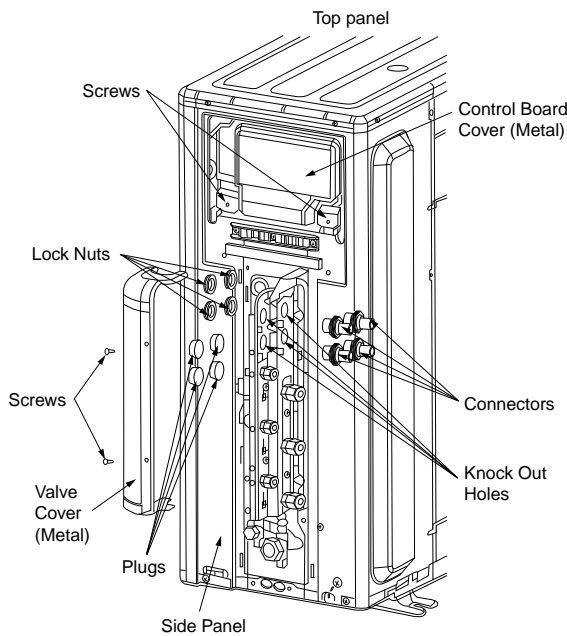
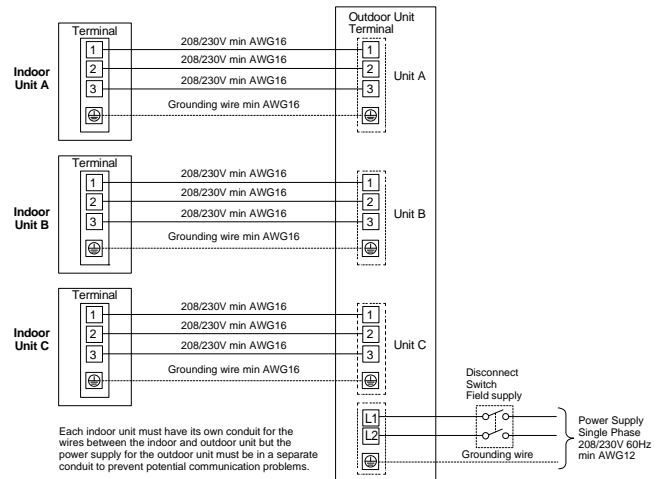

8. For wire stripping and connection requirement, refer to the diagram below.
9. Secure the power supply cord and connection cables onto the control board with the holder.
10. Attach the control board cover (metal and resin) and valve cover back to the original position with screw.

WIRE STRIPPING AND CONNECTING REQUIREMENT

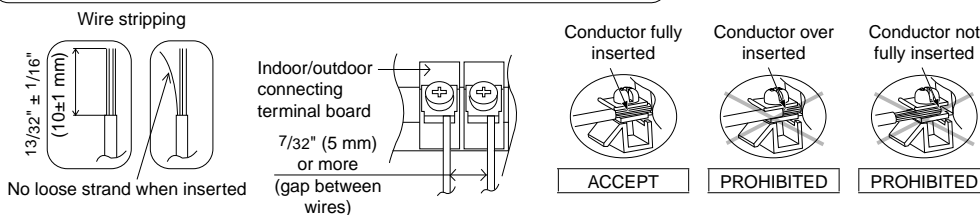

This equipment must be properly earthed.

- Ground wire must be Yellow/Green (Y/G) in colour and longer than other AC wires for safety reasons.

10.1.6 Heat Insulation

 CAUTION	Use a material with good heat-resistant properties as the heat insulation for the pipes. Be sure to insulate both the gas-side and liquid-side pipes. If the pipes are not adequately insulated, condensation or water leakages may occur.
--	--

Liquid-side pipes	Material shall withstand 248°F
Gas-side pipes	(120°C) or higher

10.1.7 Disposal Of Outdoor Unit Drain Water

- If a drain elbow is used, the unit should be placed on a stand which is taller than 1-31/32" (50 mm).
- If the unit is used in an area where temperature falls below 32°F (0°C) for 2 or 3 days in succession, it is recommended not to use a drain elbow, for the drain water freezes and the fan will not rotate.

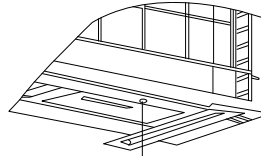

Drain elbow →  Install the hose at an angle so that the water smoothly flows out.

10.2 CU-4E24RBU

10.2.1 Select The Best Location

- If an awning is built over the unit to prevent direct sunlight or rain, be careful that heat radiation from the condenser is not obstructed.
- There should not be any animal or plant which could be affected by hot air discharged.
- Keep the spaces indicated by arrows from wall, ceiling, fence or other obstacles.
- Do not place any obstacles which may cause a short circuit of the discharged air.

Refrigerant piping size	
Outdoor Unit	CU-4E24***
Liquid - side	ø1/4" (ø6.35 mm) thickness 1/32" (t0.8 mm)
Gas - side	ø3/8" (ø9.52 mm) thickness 1/32" (t0.8 mm) ø1/2" (ø12.7 mm) thickness 1/32" (t0.8 mm)

* In the case of indoor unit is CS-E24***, a gas-pipe of ø1/2" (ø12.7 mm) thickness 1/32" (t0.8 mm) must be used together with CZ-MA2P (pipe size expander)

Outdoor Unit	CU-4E24***
Min. total piping length for additional gas	147.6 ft (45 m)

- If total piping length of all indoor units exceeds the minimum length listed above, charge additionally with 0.2 oz (20g) of refrigerant (R410A) for each additional foot (meter) of piping.

10.2.1.1 Outdoor Unit Installation Diagram

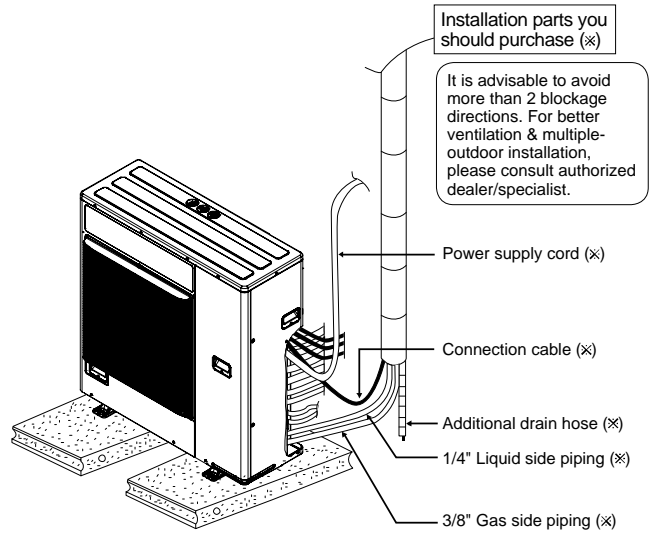

• This illustration is for explanation purposes only.

* Note:
Respective indoor unit installation procedure shall refer to instruction manual provided in the indoor unit packaging.

Allowable piping length			
Outdoor Unit		CU-4E24***	
Allowable piping length of each indoor unit (min. ~ max.)		9.8 ft ~ 82.0 ft (3 m ~ 25 m)	
Allowable total piping length of all indoor unit		229.6 ft (70 m) or less	
Height difference between indoor and outdoor unit	Outdoor unit located on upper side	a	49.2 ft (15 m) or less
	Outdoor unit located otherwise	b	24.6 ft (7.5 m) or less
	Outdoor unit located otherwise	e	49.2 ft (15 m) or less
Height difference between indoor unit	Outdoor unit located on upper side	c	24.6 ft (7.5 m) or less
	Outdoor unit located otherwise	d	49.2 ft (15 m) or less

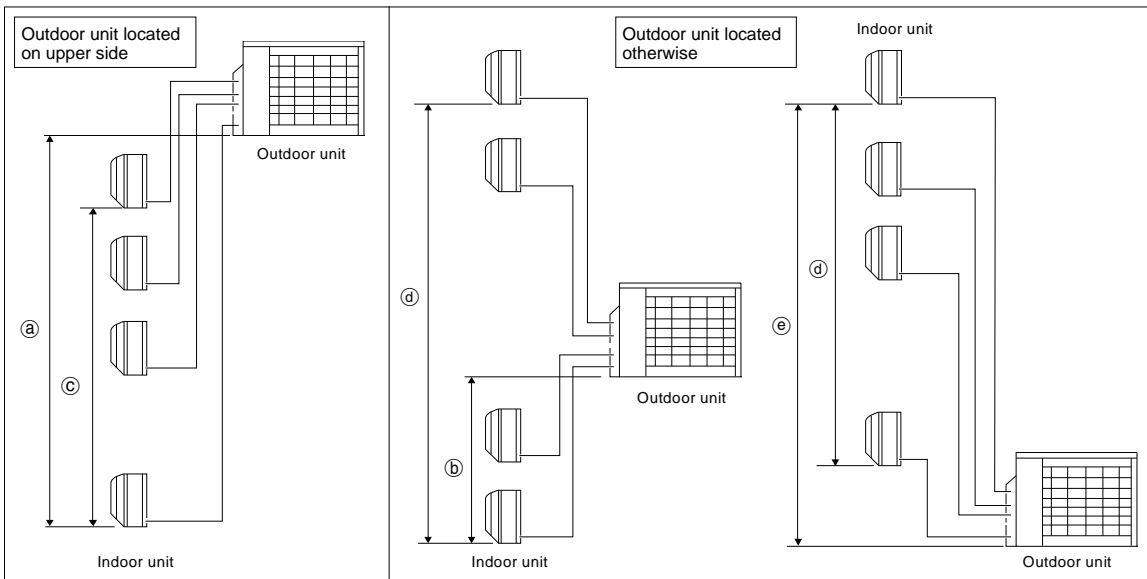

Outdoor Unit Installation Guidelines

- Where a wall or other obstacle is in the path of outdoor unit's intake or exhaust airflow, follow the installation guidelines below.
- For any of the below installation patterns, the wall height on the exhaust side should be 47-1/4" (1200 mm) or less.

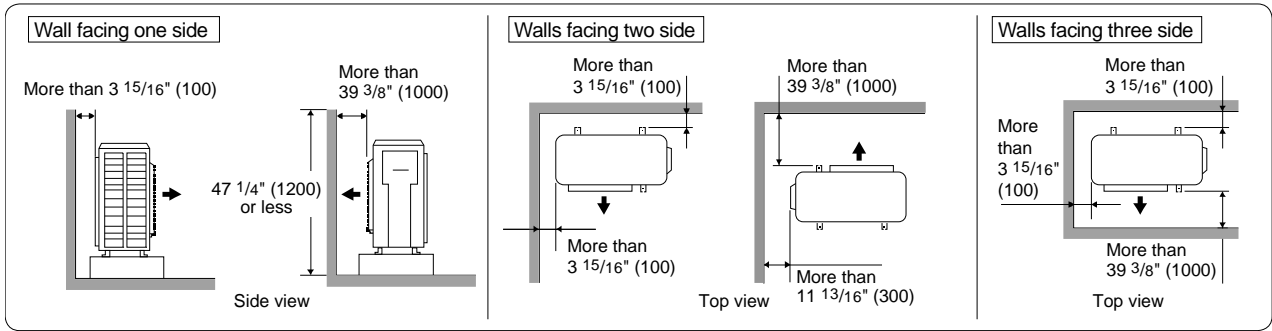

Unit : inch (mm)

10.2.2 Install The Outdoor Unit

- After selecting the best location, start installation to Indoor/Outdoor Unit Installation Diagram.
 1. Firmly attach the unit horizontally to concrete or a rigid frame with bolts and nuts (ø13/32" (ø10 mm)).
 2. When installing on a roof, please consider strong winds and earthquakes. Please fasten the installation stand firmly with bolts or nails.

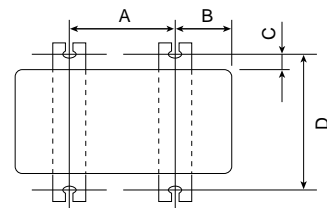

Model	A	B	C	D
CU-4E24***	24-13/32" (620 mm)	6-11/16" (170 mm)	25/32" (20 mm)	14-31/32" (380.5 mm)

10.2.3 Connect The Piping

- Remove the cabinet side plate (metal) from the unit by loosening six screws.

Connecting The Piping To Outdoor Unit

Decide piping length and then cut by using pipe cutter. Remove burrs from cut edge. Make flare after inserting the flare nut (locate at valve) onto the copper pipe.

Align center of piping to valves and then tighten with torque wrench to the specified torque as stated in the table.

Do not over tighten, over tightening may cause gas leakage	
Piping size	Torque
1/4" [6.35 mm]	13.3 lbf•ft [18 N•m (1.8 kgf•m)]
3/8" [9.52 mm]	31.0 lbf•ft [42 N•m (4.3 kgf•m)]
1/2" [12.7 mm]	40.6 lbf•ft [55 N•m (5.6 kgf•m)]
5/8" [15.88 mm]	47.9 lbf•ft [65 N•m (6.6 kgf•m)]
3/4" [19.05 mm]	73.8 lbf•ft [100 N•m (10.2 kgf•m)]

Gas Leak Checking

Pressure test to system to 400 PSIG with dry nitrogen, in stages.

Thoroughly leak check the system.

If the pressure holds, release the nitrogen and proceed to section 10.2.4.

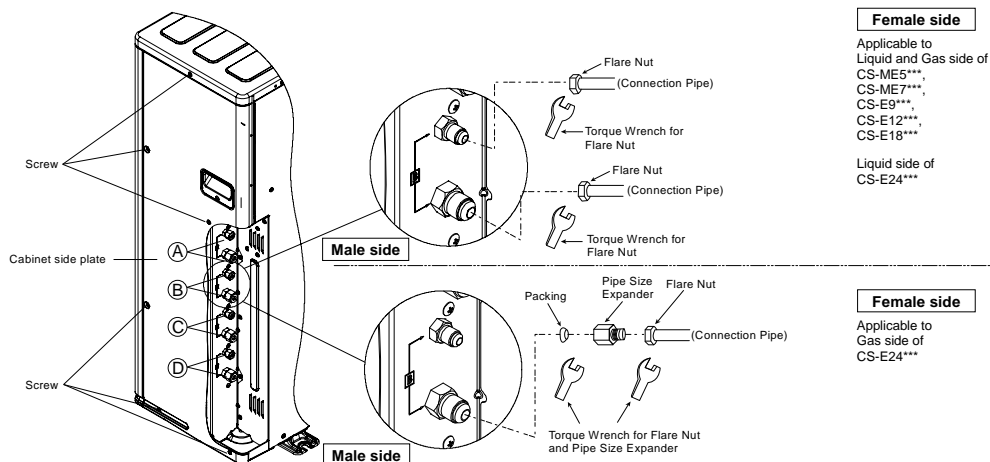

CUTTING AND FLARING THE PIPING

1. Please cut using pipe cutter and then remove the burrs.
2. Remove the burrs by using a reamer. If burrs are not removed, gas leakage may occur. Turn the piping end down to avoid the metal powder entering the pipe.
3. Please make flare after inserting the flare nut onto the copper pipes.

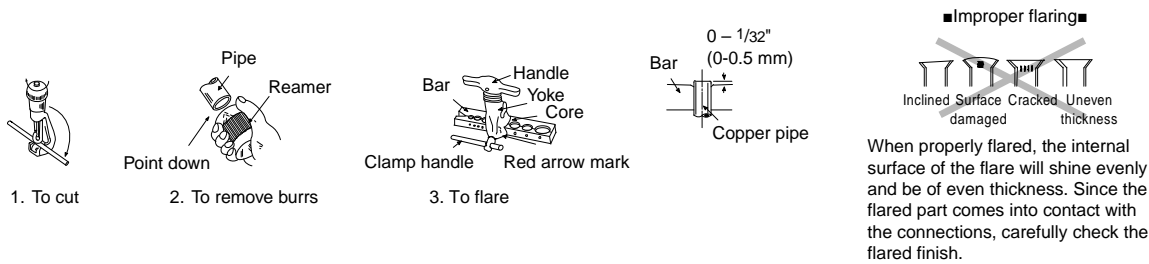

10.2.4 Evacuation Of The Equipment

WHEN INSTALLING AN AIR CONDITIONER, BE SURE TO EVACUATE THE AIR INSIDE THE INDOOR UNIT AND PIPES in the following procedure.

1. Connect a charging hose with a push pin to the Low side of a charging set and the service port of the gas side 3-way valve.
2. Connect the micron gauge between vacuum pump and service port of outdoor units.
3. Turn on the power switch of the vacuum pump and make sure to connect the digital micron gauge and to lower to a value of 500 microns.
4. Make sure micron gauge indicates a value of 500 microns and close the low side valve of the charging set and turn off the vacuum pump.
5. Disconnect the vacuum pump house from the service port of the 3-way valve.
6. Tighten the service port caps of gas side 3-way valve at a torque of 13.3 lbf•ft (18 N•m) with a torque wrench.
7. Remove the valve caps of both the 2-way valve and 3-way valve. Position both of the valves to "Open" using a hexagonal wrench (5/32" (4 mm)).
8. Mount valve caps onto the 2-way valve and 3-way valve.
 - o Be sure to check for gas leakage.

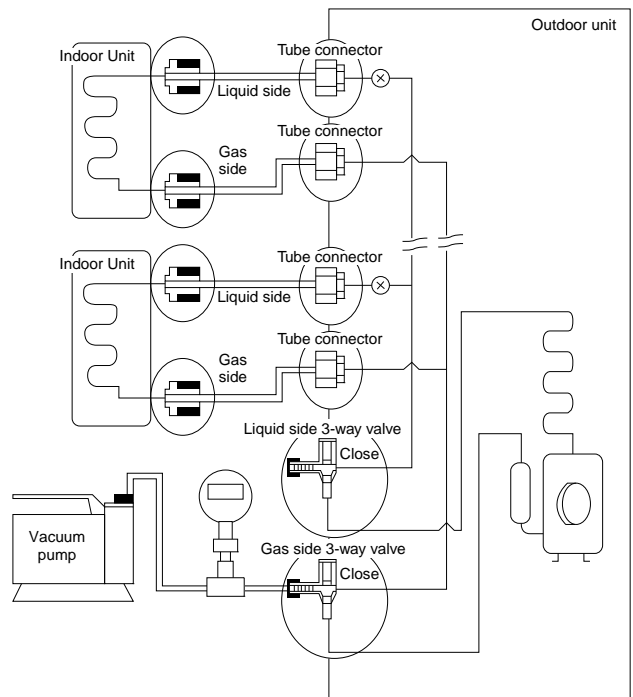

CAUTION

- If micron gauge value does not descend 500 microns, take the following measures:
 - If the leak stops when the piping connections are tightened further, continue working from step ③.
 - If the leak does not stop when the connections are retightened, repair location of leak.
 - Do not release refrigerant during piping work for installation and reinstallation.
 - Be careful when handling the liquid refrigerant, it may cause frostbite.

10.2.5 Connect The Cable To The Outdoor Unit

1. Remove Plugs.
2. Fix the conduit connectors to the knock out holes with lock-nuts, then secure them.
3. Connecting wire between indoor unit and outdoor unit should be UL listed or CSA approved 4 conductor wires minimum AWG16 in accordance with local electric codes.
4. Wire Connection to the power supply (208/230V 60Hz) through circuit breaker.
 - Connect the UL listed or CSA approved wires minimum AWG12 to the terminal board, and connect to other end of the wires to circuit breaker.
5. Connect the power supply cord and connecting wires between indoor unit and outdoor unit according to the diagram as shown.

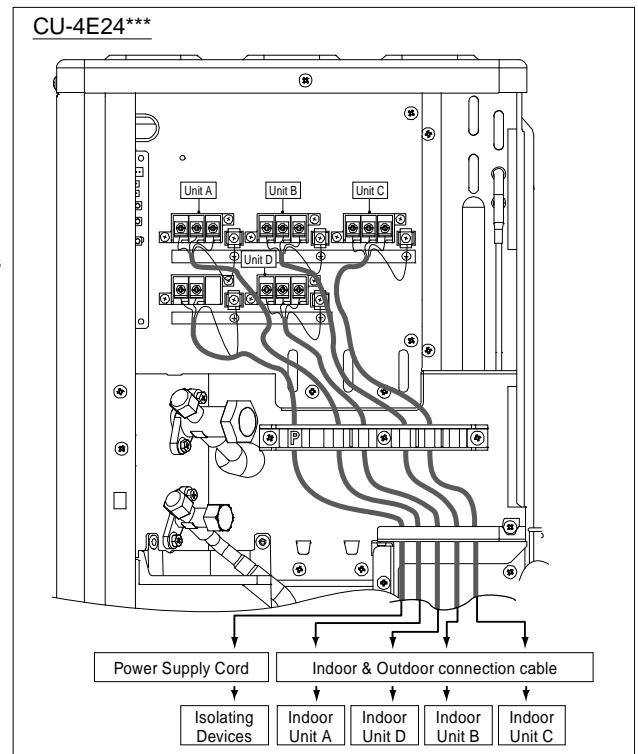
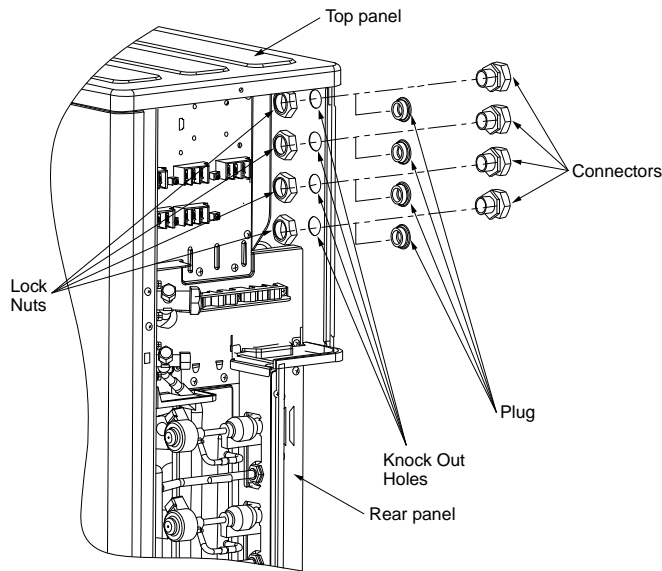
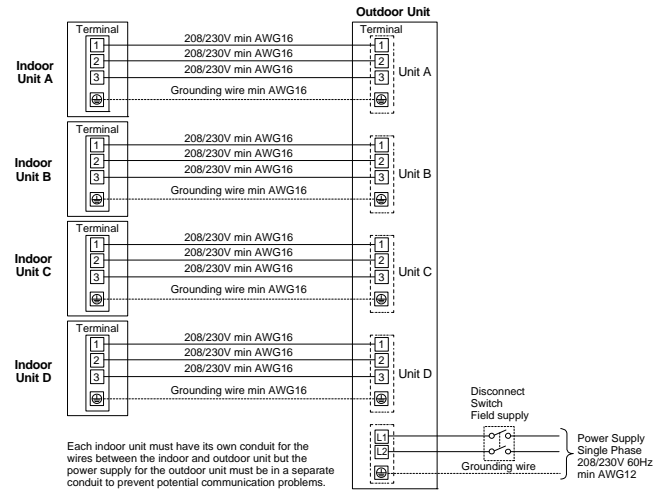

6. For wire stripping and connection requirement, refer to the diagram below.
7. Secure the power supply cord and connection cables onto the control board with the holder.
8. Fix the cabinet side plate (metal) back to the original position with screws.

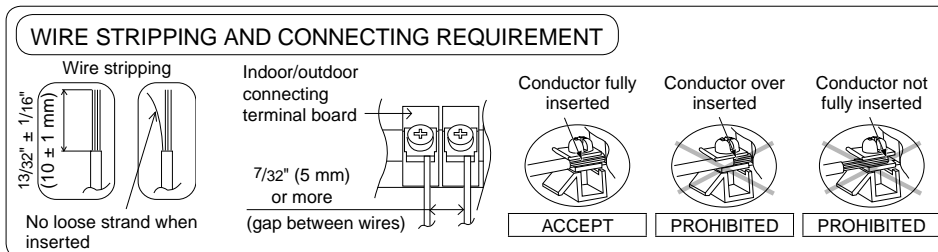

- ⚡ This equipment must be properly earthed.
- Ground wire shall be Yellow/Green (Y/G) in colour and longer than other AC wires for safety reason.

10.2.6 Heat Insulation

 CAUTION	Use a material with good heat-resistant properties as the heat insulation for the pipes. Be sure to insulate both the gas-side and liquid-side pipes. If the pipes are not adequately insulated, condensation or water leakages may occur.
--	--

Liquid-side pipes	Material shall withstand 248°F (120°C) or higher
Gas-side pipes	

10.2.7 Disposal Of Outdoor Unit Drain Water

- If a drain elbow is used, the unit should be placed on a stand which is taller than 1-31/32" (50 mm).
- If the unit is used in an area where temperature falls below 32°F (0°C) for 2 or 3 days in succession, it is recommended not to use a drain elbow, for the drain water freezes and the fan will not rotate.

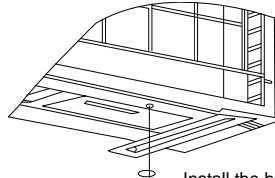

Drain elbow →  Install the hose at an angle so that the water smoothly flows out.

11. Operation Control

11.1 Cooling Operation

11.1.1 Outdoor fan control

- When cooling operation is enabled, based on outdoor ambient temperature, fan motor control will be adjusted according to figure below:

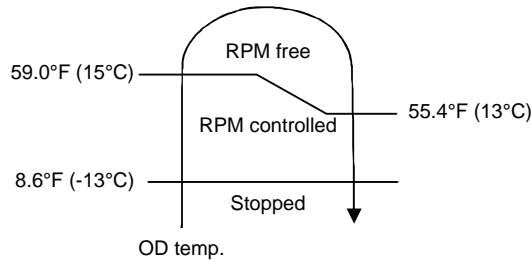

11.1.2 Annual Cooling control

- This control is to enable cooling operation when outdoor ambient temperature is low.
- Control start conditions:
 - Cooling operation is activated with compressor ON.
 - Outdoor ambient temperature is less than 59°F (15°C).
- Control contents:
 - When the above conditions are fulfilled, based on outdoor pipe temperature, the outdoor fan motor will operate according to figure below:

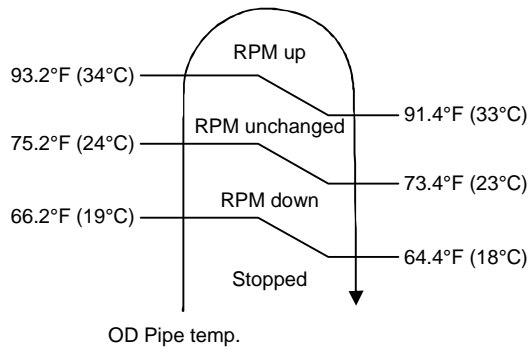

- To improve the judgment accuracy during annual cooling control, outdoor ambient temperature sampling for 2 minutes will be activated every 35 minutes under designated fan speed.
- Control stop conditions:
 - When either one of the start conditions are not complied.

11.1.3 Cooling Powerful Operation 1

- During cooling operation, this control is to concentrate outdoor unit capability to the powerful operation enabled indoor unit by temporary stop the capability supply to low load demand indoor units.
- Operation start condition:
 - Powerful operation ON for targeted indoor unit.
- Operation content:
 - If other indoor units (where Powerful operation are OFF) achieve setting temperature continuously for 1 minute after received powerful command from indoor unit, then capability supply to other indoor units are stopped for minimum 3 minutes.
Capability supply stop period follows powerful operation period.
- Operation stops when comply either one of the following conditions:
 - When other indoor units (where Powerful operation are OFF) is demand for capacity.
 - When the powerful operation is OFF for all indoor units.
 - When Quiet operation received from 1 indoor unit.
 - When protection control starts.

11.2 Heating Operation

11.2.1 Outdoor fan control

- When heating operation is enabled, based on outdoor ambient temperature, fan motor control will be adjusted according to figure below for Heating overload control:

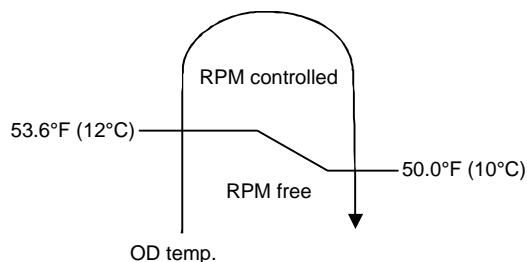

11.2.2 Heating Room Temp Sampling Control

- To improve the judgment accuracy, indoor room temperature sampling starts when any indoor unit has stopped capability supplied (heating thermo-off) during heating operation with compressor ON, outdoor unit will send signal to all thermo-off indoor units to ON fan motor and get room temperature sample.
- To prevent discharge temperature drop at indoor units which is ON when sampling the room temperature of heating thermo-off units, the compressor frequency is increased accordingly.
- However, if indoor room temperature is much higher compare to remote control setting temperature, before thermo-off, sampling of corresponding indoor unit will be cancelled.

11.2.3 Powerful Operation 2

- During cooling / heating operation, this control is to provide fast cooling / heating operation compare to normal operation.
- Operation start if all condition below are complied:
 - Powerful operation ON for indoor unit.
 - Not under Annual Cooling control.
- Operation content:
 - Outdoor fan speed will adjust automatically.
 - Compressor frequency will adjust automatically.
- Operation stop when comply either one of the follow conditions:
 - When the powerful operation is OFF for all indoor units.
 - When annual cooling control activated.

12. Simultaneous Operation Control

- Operation modes which can be selected using the remote control unit:
 - Automatic, Cooling, Dry, Heating and e-ion operation mode.
- Types of operation modes which can be performed simultaneously
 - Cooling operation and Cooling, Dry or e-ion operation.
 - Heating operation and Heating operation.
- Types of operation modes which cannot be performed simultaneously
 - During cooling operation, heating operation is impossible at another indoor unit in another room.
 - The priority is given to cooling operation if the cooling mode is selected first. In another room where heating mode is selected afterward, the POWER LED blinks to indicate the heating operation is in standby condition, where the fan is stopped hence no discharged air.
 - During heating operation, cooling operation is impossible at another indoor unit in another room.
 - The priority is given to heating operation if the heating mode is selected first. In another room where cooling mode is selected afterward, the POWER LED blinks to indicate the cooling operation is in standby condition, where the fan is stopped hence no discharged air.
- Operation mode priority control
 - The operation mode designated first by the indoor unit has priority.
 - If the priority indoor unit stops operation or initiates the fan operation, the priority is transferred to other indoor units.

“Waiting” denotes the standby status in which the POWER LED blinks (ON for 2.5 seconds and OFF for 0.5 seconds) and the fan is stopped.

		ROOM A	Non Priority Unit (2 nd ON)			
			Cooling	Dry	Heating	e-ion
Priority Unit (1 st ON)	Cooling	C	D	Waiting	E	
	Dry	C	D	Waiting	E	
	Heating	D	D	D	D	
	e-ion	Waiting	Waiting	H	Stop	
		H	H	H	H	
		C	D	H	E	
		E	E	Stop	E	

In the e-ion mode, priority is transferred to a non-priority unit.

Note

- C: Cooling operation mode
- D: Dry operation mode
- H: Heating operation mode
- E: e-ion operation mode

13. Protection Control

13.1 Freeze Prevention control (Cool)

- When received freeze prevention signal from indoor unit, the compressor frequency changes according to indoor heat exchanger temperature.
- When indoor unit request capability OFF due to freeze condition, immediately the capability supply to targeted indoor unit stops.

13.2 Dew Prevention control (Cool)

- When received dew prevention signal from indoor unit, which according to indoor intake temperature and indoor heat exchanger temperature the compressor frequency changes.

13.3 Electronic Parts Temperature Rise Protection 1 (Cool)

- This control prevents electronic parts temperature rise during cooling overload condition.
- Start conditions:
 - Outdoor ambient temperature is at protection region as shown in figure below:

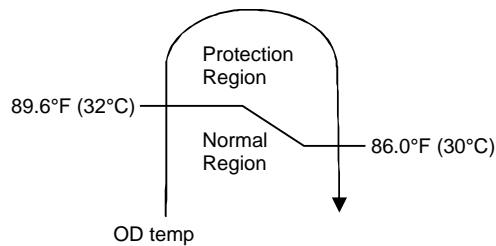

- Outdoor unit total current is above 5.0A.
- Control content
 - Outdoor fan speed is adjusted accordingly.
- Control stop condition
 - When outdoor ambient temperature is back to normal region.
- During this control, outdoor fan speed does not reduce for Quiet operation.

13.4 Electronic Parts Temperature Rise Protection 2 (Cool)

- This control prevents electronic parts temperature rise during cooling/dry operation.
- Start conditions:
 - Total current is at protection region as shown in figure below:

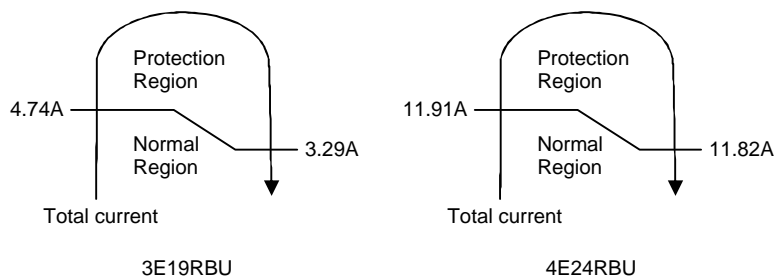

- Control content
 - Outdoor fan speed is adjusted accordingly.
- Control stop conditions
 - When total current is back to normal region.
- During this control, outdoor fan speed does not reduce for Quiet operation.

13.5 Cooling overload control (Cool)

- This control detect outdoor pipe temperature and perform the compressor frequency restriction during cooling operation.

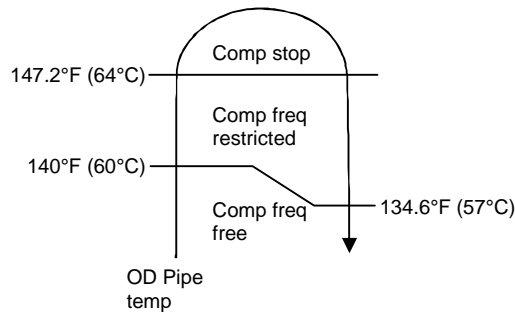

- The compressor will be stopped to avoid compressor overloading.

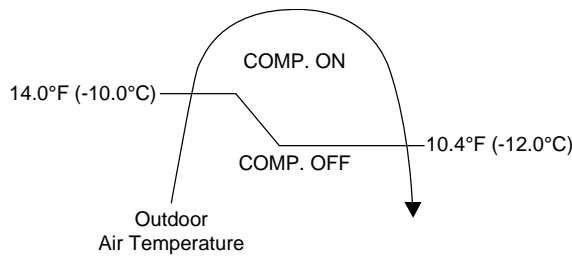

13.6 Heating overload control (Heat)

- This control detect indoor pipe temperature and perform the compressor frequency restriction during heating operation.

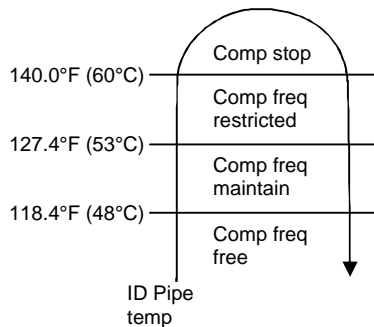

- This control detect outdoor ambient temperature and perform the fan speed adjustment during heating operation.

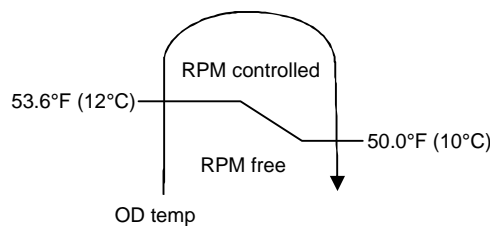

- The compressor will be stopped to avoid compressor overloading.

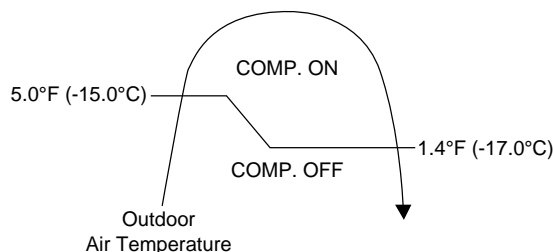

13.7 Extreme Low Temperature Compressor low pressure protection control (Heat)

- This control is to prevent low pressure drops too low during extremely low outdoor ambient temperature to improve the compressor reliability.
- During heating operation, when outdoor ambient temperature is in Zone 1, this control will be activated. Compressor frequency restriction will be based on outdoor piping temperature.

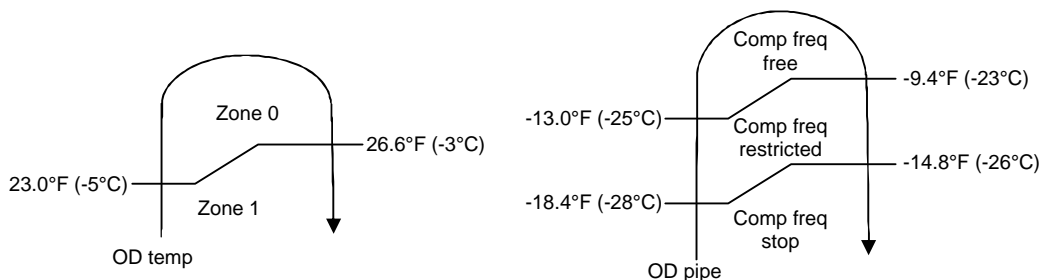

13.8 Deice Control

- When outdoor pipe temperature and outdoor air temperature is low, deice operation starts where indoor fan motor and outdoor fan motor stop, indoor unit horizontal vane close and operation LED blink with compressor ON.

13.9 Time Delay Safety Control (Restart Control)

- The compressor will not restart within three minutes after compressor is stopped.
- This control is not applicable if the power supply reset or after deice condition.

13.10 30 seconds Force Operation

- Once the compressor starts operation, it will not stop its operation for 30 seconds in order to cycle back compressor oil.
- However, it can be stopped using remote control or Auto OFF/ON button at indoor unit.

13.11 Total Current Control

- By referring to table below, during normal (default) operation, the running current refer to Hi values and during Power Save Mode, the running current refer to Lo values.
- When the outdoor unit total running current (AC) exceeds X value, compressor frequency will decrease.
- If the running current does not exceed X value for 5 seconds, compressor frequency will increase.
- However, if total outdoor unit running current exceeds Y value, compressor will be stopped immediately for 3 minutes.

Operation Mode		CU-3E19RBU		CU-4E24RBU	
		X (A)	Y (A)	X (A)	Y (A)
Cooling/Soft Dry (A)	Hi	14.0	17.5	18.06	23.07
	Lo	9.8		12.63	
Cooling/Soft Dry (B)	Hi	14.0		17.32	
	Lo	9.8		12.63	
Heating	Hi	14.0		20.33	
	Lo	9.8		14.03	

- The first 30 minutes of cooling operation, (A) will be applied.

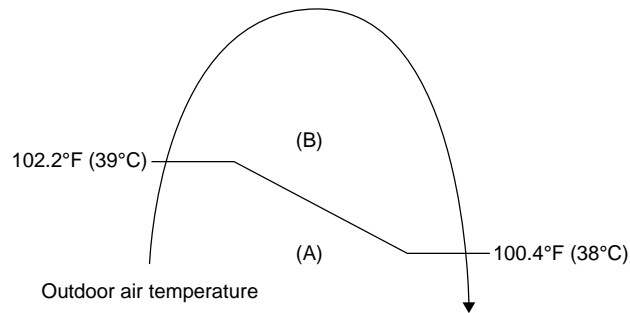

13.12 IPM (power transistor) Protection Control

- Overheating Prevention Control
 - If IPM temperature rises to 176°F (80°C), outdoor fan speed will be increased.
 - When the IPM temperature rises to 203°F (95°C), compressor operation will stop immediately.
 - Compressor operation restarts when temperature decreases to 194°F (90°C).
 - If IPM temperature detected less than -22°F (-30°C), IPM is judged as open circuit ("F96" is indicated).
- DC peak current control
 - When IPMDC current exceeds set value of 30.0 ± 3.0 A, the compressor will stop.
 - If the DC peak current detected within 30 seconds after operation starts, compressor will restart after 1 minute.
 - If the DC peak current detected 30 seconds or more after operation starts, compressor will restart after 2 minutes.
 - Within 30 seconds after compressor restarts, if the DC peak current is exceeded set value continuously for 7 times, all indoor and outdoor relays will be cut off ("F99" is indicated).
- Error reset can be done by power supply reset.

13.13 Compressor Protection Control (Gas leak detection control 1)

- Control start conditions
 - For 5 minutes, the compressor continuously operates and total current is low.
 - During Cooling or Soft Dry operation:
Indoor intake temperature — indoor piping temperature is below 39.2°F (4°C).
 - During Heating operation:
Indoor pipe temperature — indoor intake temperature is below 37.4°F (3°C).
 - Not during deice control.
 - Compressor ON with maximum frequency.
- Control content
 - Compressor stops (and restart after 3 minutes)
 - If the conditions above happen 4 times within 60 minutes, the unit will stop operation ("F91" is indicated).

13.14 Compressor Protection Control (Gas leak detection control 2)

- This control detect gas leakage condition to prevent compressor damage.
- Control start condition
 - All connected indoor units capability supply ON.
 - Compressor ON with maximum frequency.
 - Not during annual cooling.
 - Compressor discharge temperature high.
- Control content
 - Compressor OFF during this control ("F91" is memorized in EEPROM)
 - If the above conditions happen 2 times within 60 minutes, indoor units' Timer LED will blinks ("F91" is indicated at all indoor units)

13.15 Valve close detection control

- This control detects 3-way valve close condition to prevent damage to refrigerant cycle.
- Start conditions:
 - For all connected indoor units, if Indoor intake temperature — indoor piping temperature are between 28.4°F (-2°C) and 35.6°F (2°C) continuously for 5 minutes after compressor ON at first cooling operation.
 - The first cooling operation is defined as cooling operation is ON for less than 8 minutes after new installation or after pump down.
- Control content
 - During this control, compressor stop, indoor units' Timer LED will blink. ("F91" is indicated at indoor units)
- Error reset can be done by power supply reset or reset by using remote control.

13.16 Compressor discharge high pressure protection control

- This control protect by using high pressure switch during operation.
- Start conditions
 - High pressure switch is activated (from normally close to open) when outdoor operation mode is cooling or heating during compressor running.
- Control 1 content
 - Compressor stop when high pressure switch is opened and restart after high pressure switch closed. If this condition happen 4 times within 30 minutes, "F94" is indicated.
 - After 30 minutes, counter is reset if this condition does not happen for 4 times.
- Control 1 stop conditions
 - Power supply reset
 - Reset by using remote control

14. Servicing Mode

14.1 CU-3E19RBU

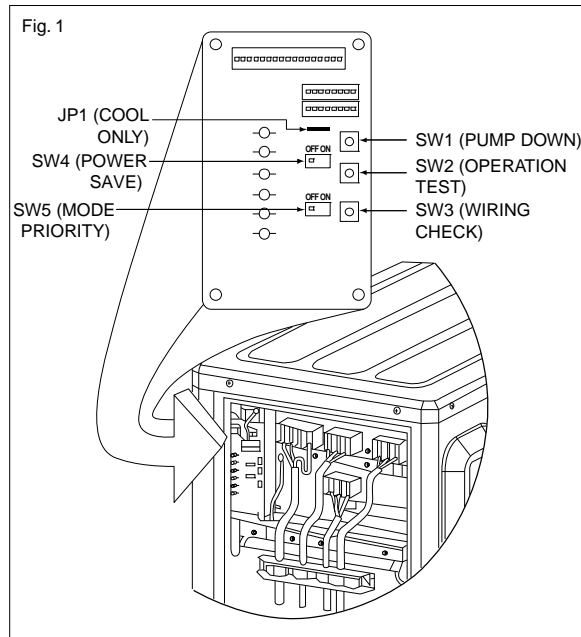

14.1.1 Pump down operation (SW1)

- Operate the pump down process according to the following procedure.
 - Confirm the valve on the liquid side and gas side are open.
 - Press PUMP DOWN button (SW1) on the Display PCB inside the outdoor unit for more than 5 seconds. Pump down (cooling) operation is performed for 15 minutes.
 - Set the liquid side 3 way valve to close position and wait until the pressure gauge indicates 0.01MPa (1.45 PSI).
 - Immediate set the gas side valve to close position and then press the PUMP DOWN button (SW1) to stop the pump down operation.

NOTE: Pump down operation will stop automatically after 15 minutes if PUMP DOWN switch (SW1) is not pressed again. Pump down operation is not started within 3 minutes after compressor is stopped.

LED	2	3	4	5	Message
Status	○	○	○	○	Pump down operation in progress
	○	○	○		3 minutes before operation end
	○	○			2 minutes before operation end
	○				1 minute before operation end
					Pump down operation end

○: Blinking

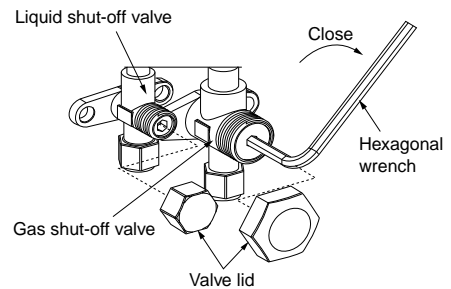

14.1.2 Test Run Operation

- Test operation can be carried out using OPERATION TEST button (SW2) on the Display PCB inside the outdoor unit.
- For Cooling test, press the OPERATION TEST button (SW2) for 5 seconds or more but less than 10 seconds, LED1 and LED 2 will illuminate when shift into cooling test operation.
- For Heating test, press the OPERATION TEST button (SW2) for more than 10 seconds, LED 1 and LED 3 will illuminate when shift into heating test operation.
- Press the OPERATION TEST button (SW2) again to cancel test operation.

14.1.3 Wiring Error Check

- The unit capable to correct the wiring error automatically by following procedures.
 - Confirm the valve on the liquid side and gas side is open.
 - Press WIRING CHECK button (SW3) on the Display PCB inside the outdoor unit for more than 10 seconds to start wiring check operation.
 - Wiring check process will complete in approximately 10 minutes. However, wiring check operation will not start within 3 minutes after compressor is stopped. When outdoor air temperature is less than 41°F (5°C) or unit has abnormality, wiring check will not start. (See NOTE 2)
- The LED 2 to LED 6 in Display PCB inside the outdoor unit indicate the possibility of the correction as shown in the table below:

LED	2	3	4	5	6	Message
Room	A	B	C	-	-	
Status	All flashing					Automatic correction impossible
	LED2, 4, 6 and LED 3, 5 alternatively flashing					Wiring check in progress
	Flashing one after another					Automatic correction completed
	Other than above					Unit has abnormality (NOTE 4)

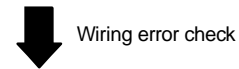
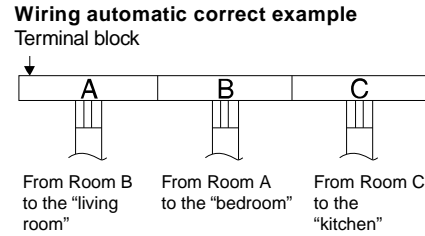

LED lighting sequence after a wiring correction.
Order of LED flashing: 3--> 2--> 4

- If automatic correct is impossible, check the indoor unit wiring and piping manually.

NOTE:

- For two rooms connection, LED 4 and 5 are not illuminated and for three rooms connections, LED 5 is not illuminated after wiring operation complete.
- If the outdoor air temperature is less than 41°F (5°C) or unit has abnormality, wiring operation will not start.
- After wiring check operation is complete, LED indication will illuminated until normal operation starts.
- Follow the product diagnosis procedure.
- When LED 1 only illuminate, indicates that outdoor unit is operating normally.

14.1.4 Power Save Mode

- Power Save Mode can be enabled by pushing POWER SAVE switch (SW4) to ON before power supply ON.
- When Power Save Mode is ON, the unit can be operate at lower running current where the breaker capacity not achieve the requirement.

14.1.5 Mode priority function

- Mode priority function can be enabled by pushing MODE PRIORITY switch (SW5) to ON before power supply ON.
- When Mode Priority Function is ON, the mode priority is given to higher capacity indoor units.

14.1.6 Cooling only function

- The unit capable to limit the operation mode to Cooling Mode only (Heating mode disabled) by cutting JP1 (COOL ONLY) before power supply ON.
- This function prevent wrong operation during the unit installed in server room.
- This function could be disabled again by short the JP1 (COOL ONLY) before power supply ON.

14.2 CU-4E24RBU

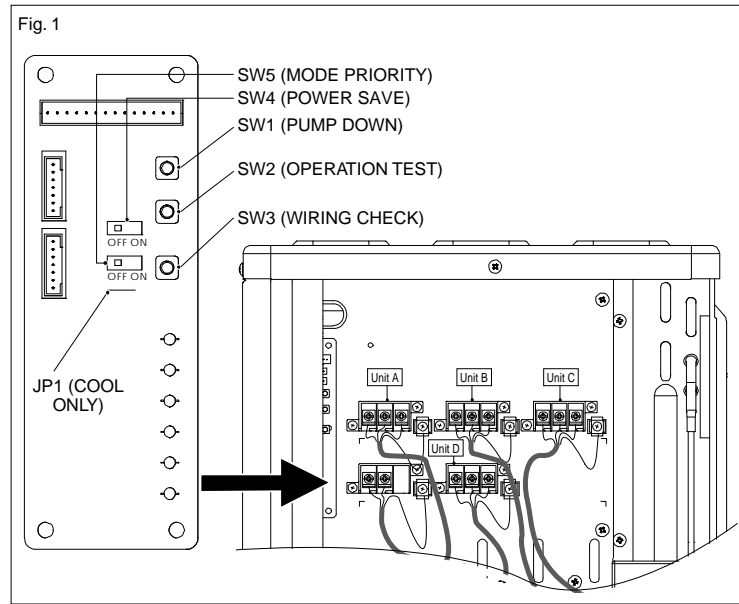

14.2.1 Pump down operation (SW1)

- Operate the pump down process according to the following procedure.
 - Confirm the valve on the liquid side and gas side are open.
 - Press PUMP DOWN button (SW1) on the Display PCB inside the outdoor unit for more than 5 seconds. Pump down (cooling) operation is performed for 15 minutes.
 - Set the liquid side 3 way valve to close position and wait until the pressure gauge indicates 0.01MPa (1.45 PSI).
 - Immediate set the gas side valve to close position and then press the PUMP DOWN button (SW1) to stop the pump down operation.

NOTE: Pump down operation will stop automatically after 15 minutes if PUMP DOWN switch (SW1) is not pressed again. Pump down operation is not started within 3 minutes after compressor is stopped.

LED	2	3	4	5	Message
Status	○	○	○	○	Pump down operation in progress
	○	○	○		3 minutes before operation end
	○	○			2 minutes before operation end
	○				1 minute before operation end
					Pump down operation end

○: Flashing

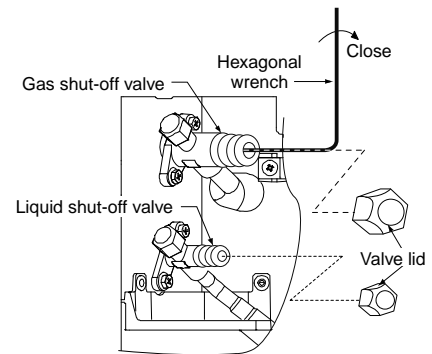

14.2.2 Test Run Operation

- Test operation can be carried out using OPERATION TEST button (SW2) on the Display PCB inside the outdoor unit.
- For Cooling test, press the OPERATION TEST button (SW2) for 5 seconds or more but less than 10 seconds, LED1 and LED 2 will illuminate when shift into cooling test operation.
- For Heating test, press the OPERATION TEST button (SW2) for more than 10 seconds, LED 1 and LED 3 will illuminate when shift into heating test operation.
- Press the OPERATION TEST button (SW2) again to cancel test operation.

14.2.3 Wiring Error Check

- The unit capable to correct the wiring error automatically by following procedures.
 - Confirm the valve on the liquid side and gas side is open.
 - Press WIRING CHECK button (SW3) on the Display PCB inside the outdoor unit for more than 10 seconds to start wiring check operation.
 - Wiring check process will complete in approximately 20 - 25 minutes. However, wiring check operation will not start within 3 minutes after compressor is stopped. When outdoor air temperature is less than 41°F (5°C) or unit has abnormality, wiring check will not start. (See NOTE 2)
- The LED 2 to LED 6 in Display PCB inside the outdoor unit indicate the possibility of the correction as shown in the table below:

LED	2	3	4	5	6	Message
Room	A	B	C	D	-	
Status	All flashing					Automatic correction impossible
	LED2, 4, 6 and LED 3, 5 alternatively flashing					Wiring check in progress
	Flashing one after another					Automatic correction completed
	Other than above					Unit has abnormality (NOTE 4)

Automatic wiring correction example

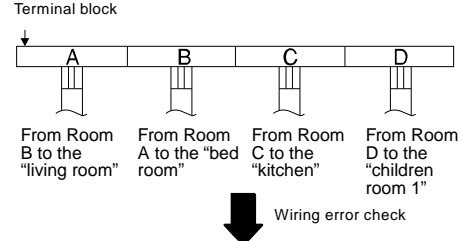

LED lighting sequence after a wiring correction.
Order of LED flashing: 3--> 2--> 4--> 5

- If automatic correct is impossible, check the indoor unit wiring and piping manually.

NOTE:

- For two rooms, LED 4,5 and 6 are not illuminated, for three rooms, LED 5 and 6 are not illuminated and for four rooms, LED 6 is not illuminated after wiring operation complete.
- If the outdoor air temperature is less than 41°F (5°C) or unit has abnormality, wiring operation will not start.
- After wiring check operation is complete, LED indication will illuminate until normal operation starts.
- Follow the product diagnosis procedure. (Check the diagnostic label at the cabinet side plate.)
- When LED 1 only illuminate, indicates that outdoor unit is operating normally.

14.2.4 Power Save Mode

- Power Save Mode can be enabled by pushing POWER SAVE switch (SW4) to ON before power supply ON.
- When Power Save Mode is ON, the unit can be operate at lower running current where the breaker capacity not achieve the requirement.

14.2.5 Mode priority function

- Mode priority function can be enabled by pushing MODE PRIORITY switch (SW5) to ON before power supply ON.
- When Mode Priority Function is ON, the mode priority is given to higher capacity indoor units.

14.2.6 Cooling only function

- The unit capable to limit the operation mode to Cooling Mode only (Heating mode disabled) by cutting JP1 (COOL ONLY) before power supply ON.
- This function prevent wrong operation during the unit installed in server room.
- This function could be disabled again by short the JP1 (COOL ONLY) before power supply ON.

15. Troubleshooting Guide

15.1 Self Diagnosis Function

- The display screen of wireless remote control unit and the self-diagnosis LEDs (green) on the outdoor printed circuit board in the outdoor unit can be used to identify the location of the problem.
Refer to the table below to identify and solve the cause of the problem, and then re-start the air conditioner system.
- If the problem is solved and operation returns to normal.
LED 1 illuminates and others LED are off.

Diagnosis display	Abnormality or protection control	LED 6	LED 5	LED 4	LED 3	LED 2	LED 1	Abnormality judgment	Protection operation	Problem	Check location
H11	Indoor/outdoor abnormal communication						○	After operation for 1 minute	Indoor fan only operation can start by entering into force cooling operation	Indoor/outdoor communication not establish	<ul style="list-style-type: none"> Indoor/outdoor wire terminal Indoor/outdoor PCB Indoor/outdoor connection wire
H12	Indoor unit capacity unmatched					○		90s after power supply	-	Total indoor capability more than maximum limit or less than minimum limit, or number of indoor unit less than two	<ul style="list-style-type: none"> Indoor/outdoor connection wire Indoor/outdoor PCB Specification and combination table in catalogue
H15	Compressor temperature sensor abnormality					○	○	Continuous for 5s	-	Compressor temperature sensor open or short circuit	<ul style="list-style-type: none"> Compressor temperature sensor lead wire and connector
H16	Outdoor current transformer (CT) abnormality				○		○	-	-	Current transformer faulty or compressor faulty	<ul style="list-style-type: none"> Outdoor PCB faulty or compressor faulty
H27	Outdoor air temperature sensor abnormality				○	○		Continuous for 5s	-	Outdoor air temperature sensor open or short circuit	<ul style="list-style-type: none"> Outdoor air temperature sensor lead wire and connector
H28	Outdoor heat exchanger temperature sensor 1 abnormality				○	○	○	Continuous for 5s	-	Outdoor heat exchanger temperature sensor 1 open or short circuit	<ul style="list-style-type: none"> Outdoor heat exchanger temperature sensor 1 lead wire and connector
H32	Outdoor heat exchanger temperature sensor 2 abnormality			○				Continuous for 5s	-	Outdoor heat exchanger temperature sensor 2 open or short circuit	<ul style="list-style-type: none"> Outdoor heat exchanger temperature sensor 2 lead wire and connector
H33	Indoor/outdoor misconnection abnormality			○			○	-	-	Indoor and outdoor rated voltage different	<ul style="list-style-type: none"> Indoor and outdoor units check
H36	Outdoor gas pipe temperature sensor abnormality			○		○		Continuous for 5s	Heating protection operation only	Outdoor gas pipe temperature sensor open and short circuit	<ul style="list-style-type: none"> Outdoor gas pipe temperature sensor lead wire and connector
H37	Outdoor liquid pipe temperature sensor abnormality			○		○	○	Continuous for 5s	Cooling protection operation only	Outdoor liquid pipe temperature sensor open or short circuit	<ul style="list-style-type: none"> Outdoor liquid pipe temperature sensor lead wire and connector
H64	Outdoor high pressure sensor abnormality			○	○			Continuous for 1 minute	-	High pressure sensor open circuit during compressor stop	<ul style="list-style-type: none"> High pressure sensor Lead wire and connector
H97	Outdoor fan motor mechanism lock			○	○		○	2 times happen within 30 minutes	-	Outdoor fan motor lock or feedback	<ul style="list-style-type: none"> Outdoor fan motor lead wire and connector Fan motor lock or block
H98	Indoor high pressure protection			○	○	○		-	-	Indoor high pressure protection (Heating)	<ul style="list-style-type: none"> Check indoor heat exchanger Air filter dirty Air circulation short circuit

Diagnosis display	Abnormality or protection control	LED 6	LED 5	LED 4	LED 3	LED 2	LED 1	Abnormality judgment	Protection operation	Problem	Check location
H99	Indoor operating unit freeze protection			○	○	○		-	-	Indoor freeze protection (Cooling)	<ul style="list-style-type: none"> • Check indoor heat exchanger • Air filter dirty • Air circulation short circuit
F11	4-way valve switching abnormality			○	○	○	○	4 times happen within 30 minutes	-	4-way valve switching abnormal	<ul style="list-style-type: none"> • 4-way valve • Lead wire and connector
F17	Indoor standby units freezing abnormality		○					3 times happen within 40 minutes	-	Wrong wiring and connecting pipe, expansion valve leakage	<ul style="list-style-type: none"> • Check indoor/outdoor connection wire and pipe • Indoor heat exchanger sensor lead wire and connector • Expansion valve lead wire and connector
F90	Power factor correction (PFC) circuit protection		○				○	4 times happen within 20 minutes	-	Power factor correction circuit abnormal	<ul style="list-style-type: none"> • Outdoor PCB faulty
F91	Refrigeration cycle abnormality		○			○		4 times happen within 60 minutes	-	Refrigeration cycle abnormal	<ul style="list-style-type: none"> • Insufficient refrigerant or valve close
F93	Compressor abnormal revolution		○			○	○	4 times happen within 20 minutes	-	Compressor abnormal revolution	<ul style="list-style-type: none"> • Power transistor module faulty or compressor lock
F94	Compressor discharge pressure overshoot protection		○		○			4 times happen within 30 minutes	-	Compressor discharge pressure overshoot	<ul style="list-style-type: none"> • Check refrigeration system
F95	Outdoor cooling high pressure protection		○		○		○	4 times happen within 20 minutes	-	Cooling high pressure protection	<ul style="list-style-type: none"> • Check refrigeration system • Outdoor air circuit
F96	Power transistor module overheating protection		○		○	○		4 times happen within 30 minutes	-	Power transistor module overheat	<ul style="list-style-type: none"> • PCB faulty • Outdoor air circuit (fan motor)
F97	Compressor overheating protection		○		○	○	○	3 times happen within 30 minutes	-	Compressor overheat	<ul style="list-style-type: none"> • Insufficient refrigerant
F98	Total running current protection		○	○				3 times happen within 20 minutes	-	Total current protection	<ul style="list-style-type: none"> • Check refrigeration system • Power source or compressor lock
F99	Outdoor direct current (DC) peak detection		○	○			○	Continuous happen for 7 times	-	Power transistor module current protection	<ul style="list-style-type: none"> • Power transistor module faulty or compressor lock

LED 1 illuminate is indicated that outdoor unit is operating normally. If the LED 1 is switched off or flashing, check the power supply and self-diagnosis indication.

● - - - - -	Illuminate
○ - - - - -	Flashing
Blank - - - - -	OFF

15.2 Self-diagnosis Method

15.2.1 H11 (Indoor/Outdoor Abnormal Communication)

Malfunction Decision Conditions

- During standby and operation of cooling and heating, the data received from outdoor unit in indoor unit signal transmission is checked whether it is normal.

Malfunction Caused

- Faulty outdoor unit PCB.
- Faulty indoor unit PCB.
- Indoor-outdoor signal transmission error due to wrong wiring.
- Indoor-outdoor signal transmission error due to breaking of wire in the connection wires between the indoor and outdoor units.
- Indoor-outdoor signal transmission error due to disturbed power supply waveform.

Abnormality Judgment:

- After operation for 1 minute.

Troubleshooting



Caution

For safety reason and to prevent component breakdown, always switch off the power before remove and connect the component.

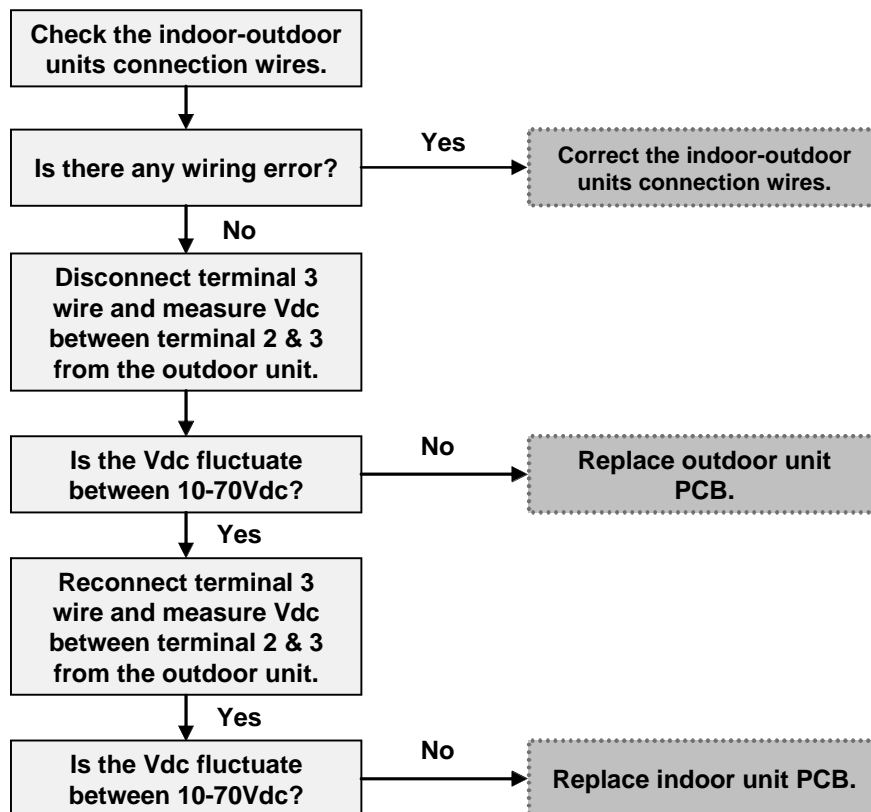

Communication voltage measurement:

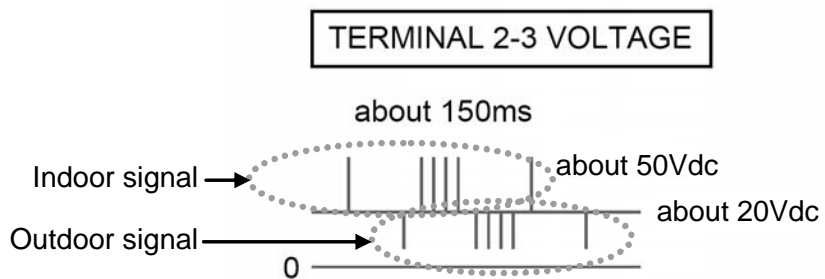

To determine if outdoor PCB or indoor PCB is faulty:

- Start with outdoor terminal first.
- Remove terminal 3 wire.
- Measure with a multimeter (voltage in DC range).
- If it is never constant, outdoor PCB is good fluctuating in between 10-70Vdc, outdoor PCB is in good condition.

15.2.2 H12 (Indoor Unit Capacity Unmatched)

Malfunction Decision Conditions

- Occur when connect in a multi free inverter system.
- However, for single split system (ONLY: CS-E21~24DKE; I/D capacity more than 5.0kW), when indoor and outdoor are disconnected from one another, H12 will appear but with conditions.

Malfunction Caused

- Wrong models interconnected.
- Wrong indoor unit and outdoor unit PCBs used.
- Indoor unit or outdoor unit PCB defective.
- Indoor-outdoor signal transmission error due to wrong wiring.
- Indoor-outdoor signal transmission error due to breaking of wire 3 in the connection wires between the indoor and outdoor units.

Abnormality Judgment:

- 90 seconds after power supply turn ON.

Troubleshooting



Caution

For safety reason and to prevent component breakdown, always switch off the power before remove and connect the component.

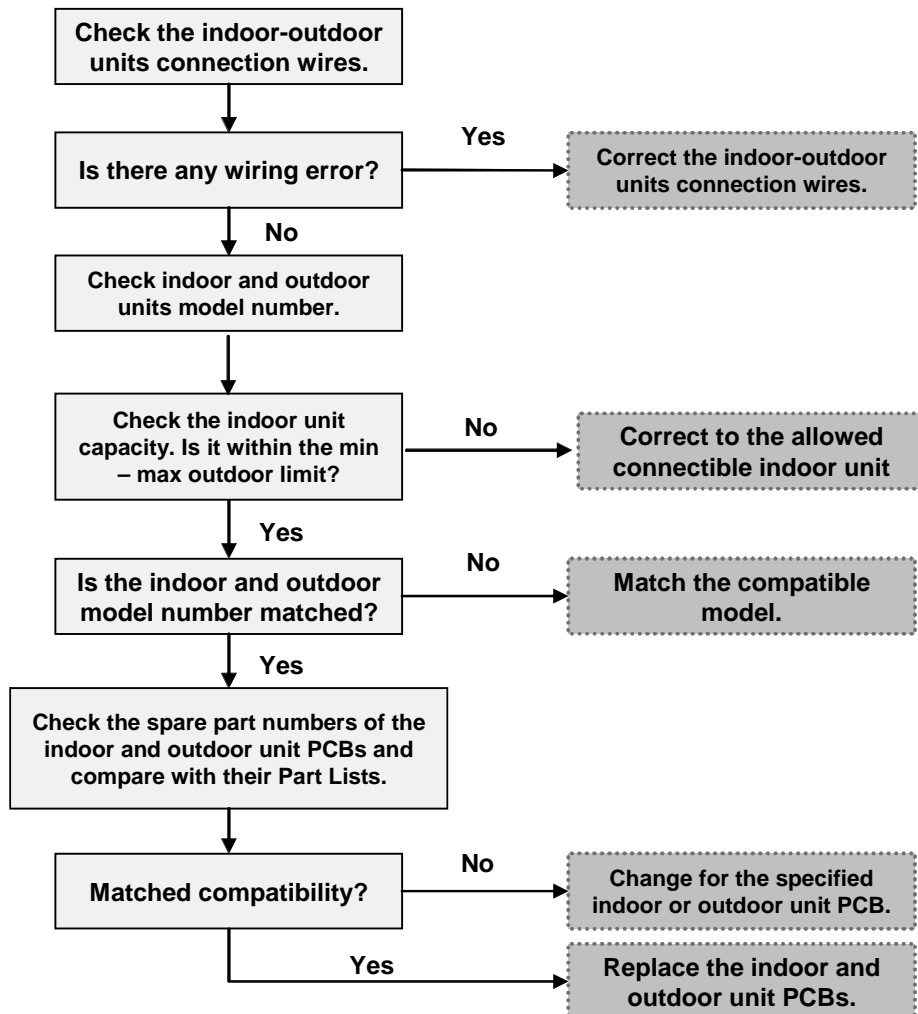

15.2.3 H15 (Compressor Temperature Sensor Abnormality)

Malfunction Decision Conditions

- During startup and operation of cooling and heating, the temperatures detected by the compressor discharge temperature sensor are used to determine sensor errors.

Malfunction Caused

- Faulty connector connection.
- Faulty sensor.
- Faulty outdoor unit PCB.

Abnormality Judgment:

- Continue for 5 seconds.

Troubleshooting



Caution

For safety reason and to prevent component breakdown, always switch off the power before remove and connect the component.

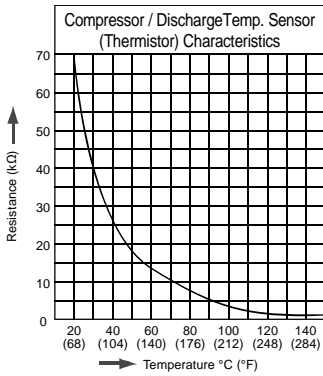
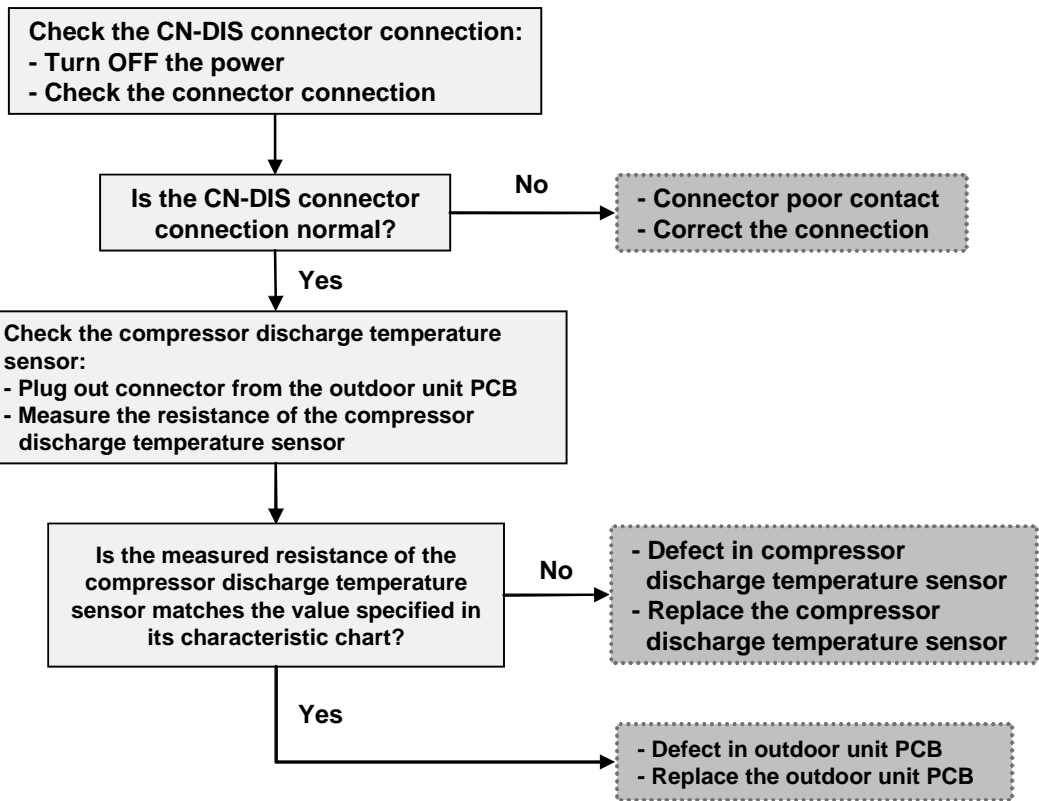

15.2.4 H16 (Outdoor Current Transformer (CT) Abnormality)

Malfunction Decision Conditions

- A current transformer (CT) is detected by checking the compressor running frequency (\geq rated frequency) and CT detected input current (less than 1.25A) for continuously 20 seconds.

Malfunction Caused

- CT defective.
- Outdoor PCB defective.
- Compressor defective (low compression).

Abnormality Judgment:

- ---

Troubleshooting



Caution

For safety reason and to prevent component breakdown, always switch off the power before remove and connect the component.

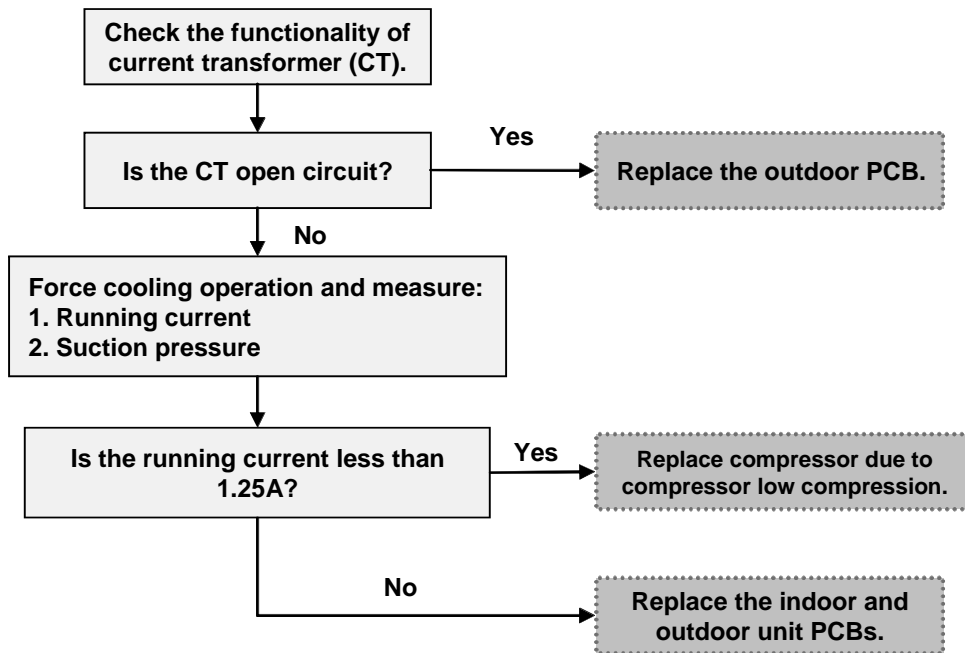

15.2.5 H27 (Outdoor Air Temperature Sensor Abnormality)

Malfunction Decision Conditions

- During startup and operation of cooling and heating, the temperatures detected by the outdoor intake air temperature sensor are used to determine sensor errors.

Malfunction Caused

- Faulty connector connection.
- Faulty sensor.
- Faulty PCB.

Abnormality Judgment:

- Continue for 5 seconds.

Troubleshooting



Caution

For safety reason and to prevent component breakdown, always switch off the power before remove and connect the component.

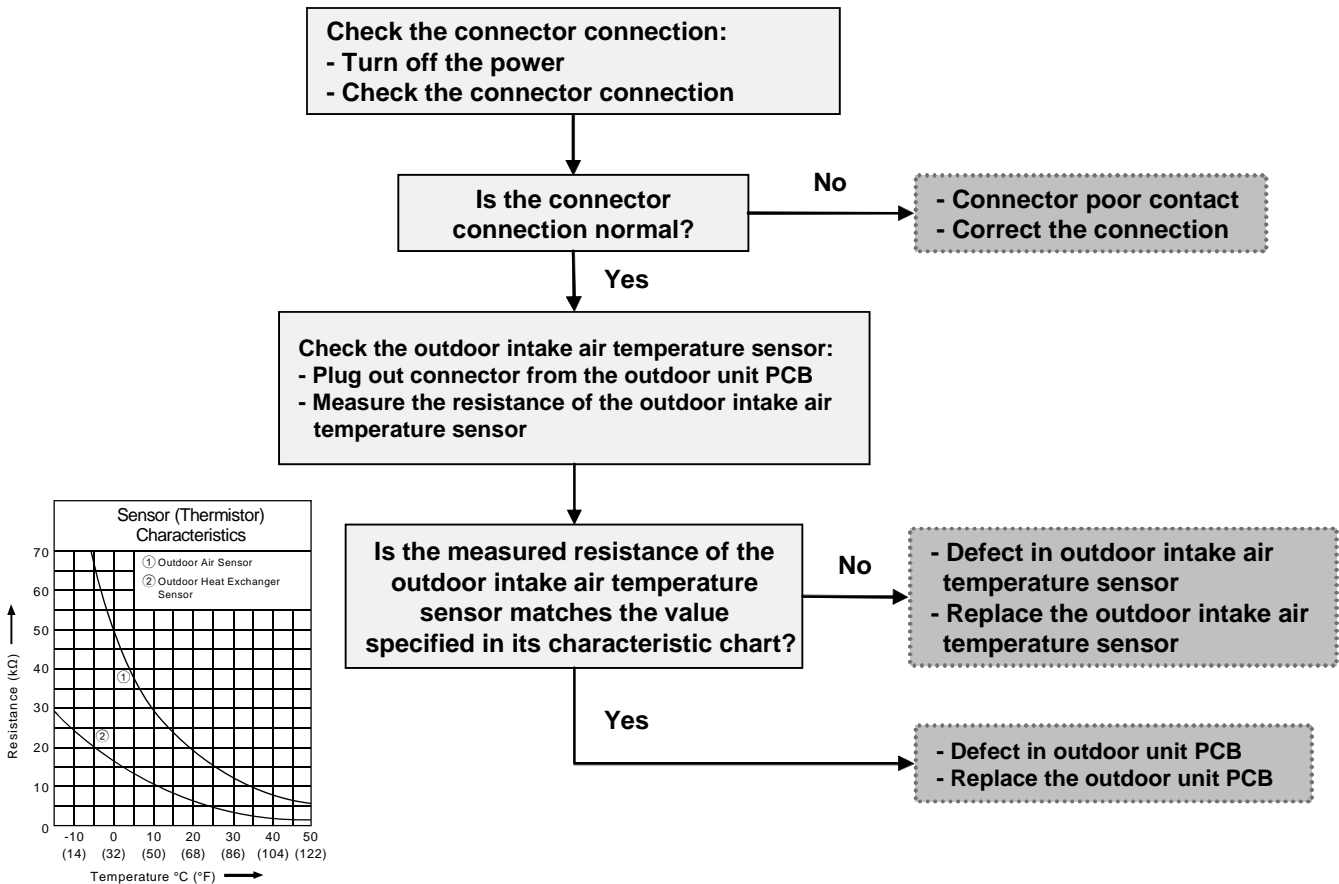

15.2.6 H28 (Outdoor Heat Exchanger Temperature Sensor 1 Abnormality)

Malfunction Decision Conditions

- During startup and operation of cooling and heating, the temperatures detected by the outdoor pipe temperature sensor are used to determine sensor errors.

Malfunction Caused

- Faulty connector connection.
- Faulty sensor.
- Faulty PCB.

Abnormality Judgment:

- Continue for 5 seconds.

Troubleshooting



Caution

For safety reason and to prevent component breakdown, always switch off the power before remove and connect the component.

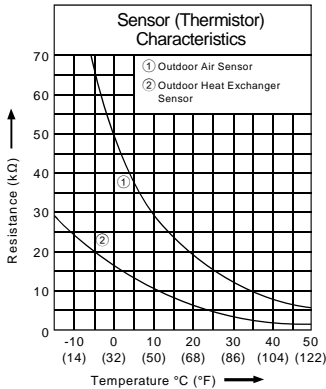
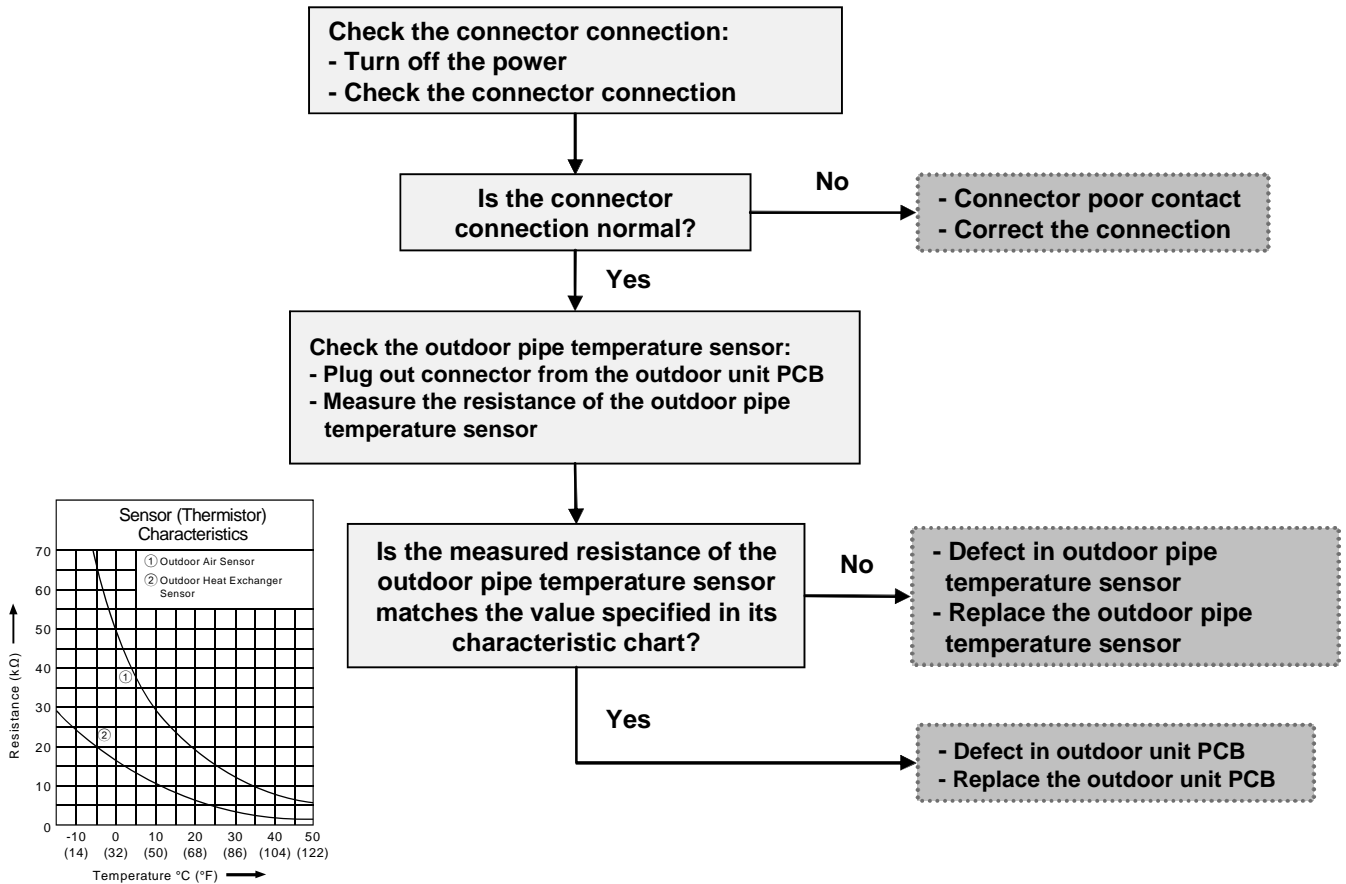

15.2.7 H32 (Outdoor Heat Exchanger Temperature Sensor 2 Abnormality)

Malfunction Decision Conditions

- During startup and operation of cooling and heating, the temperatures detected by the outdoor pipe temperature sensor 2 are used to determine sensor errors.

Malfunction Caused

- Faulty connector connection.
- Faulty sensor.
- Faulty outdoor unit PCB.

Abnormality Judgment:

- Continue for 5 seconds.

Troubleshooting



Caution

For safety reason and to prevent component breakdown, always switch off the power before remove and connect the component.

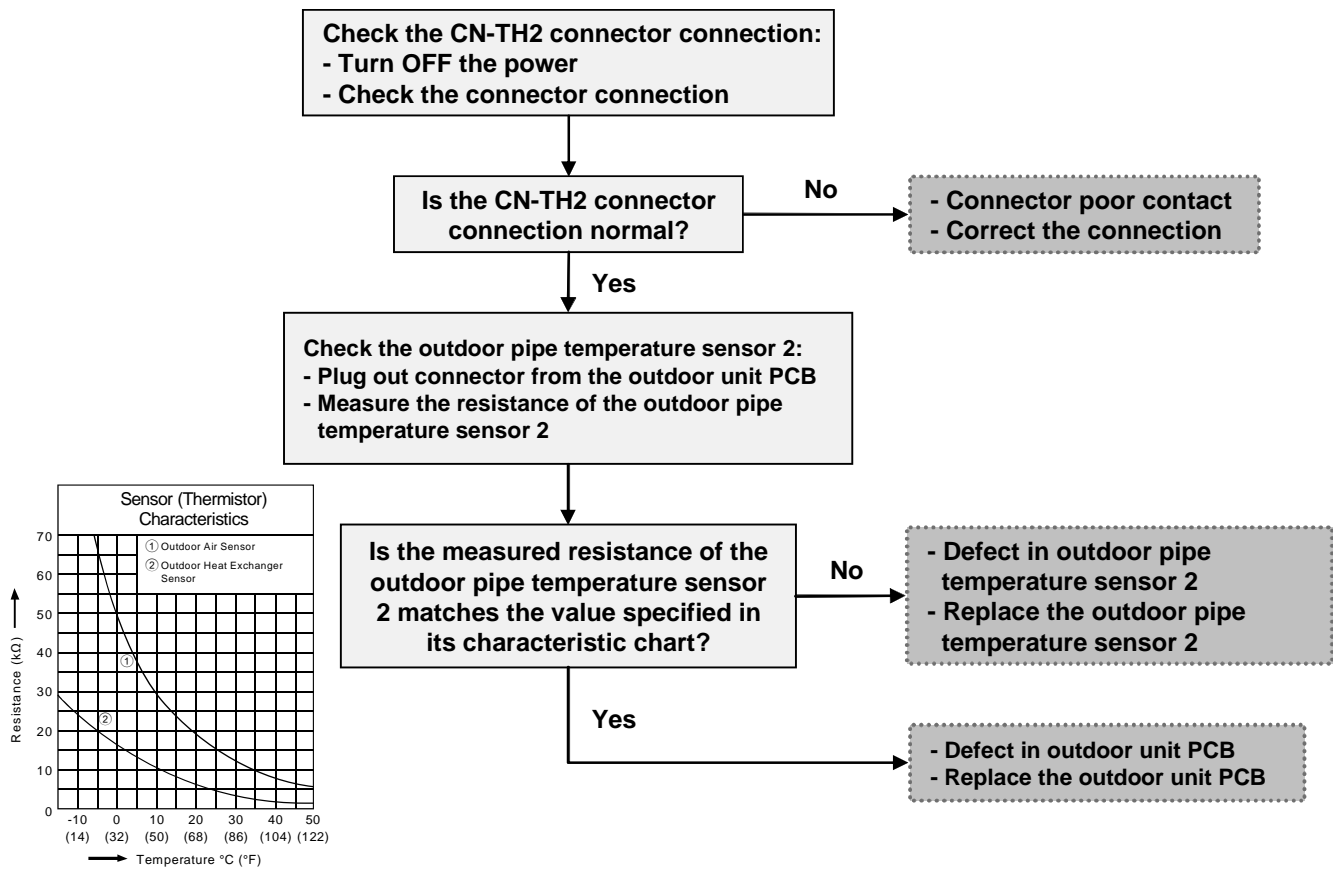

15.2.8 H33 (Indoor / Outdoor Misconnection Abnormality)

Malfunction Decision Conditions

- The supply power is detected for its requirement by the indoor/outdoor transmission.

Malfunction Caused

- Wrong models interconnected.
- Wrong indoor unit and outdoor unit PCBs used.

Troubleshooting



Caution

For safety reason and to prevent component breakdown, always switch off the power before remove and connect the component.

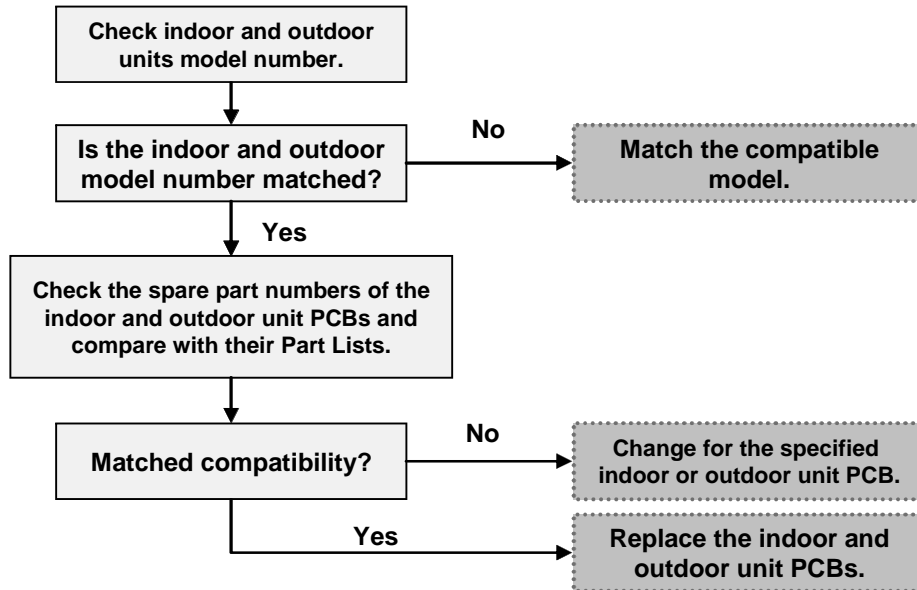

15.2.9 H36 (Outdoor Gas Pipe Temperature Sensor Abnormality)

Malfunction Decision Conditions

- During startup and operation of cooling and heating, the temperatures detected by the outdoor gas pipe temperature sensor are used to determine sensor errors.

Malfunction Caused

- Faulty connector connection.
- Faulty sensor.
- Faulty PCB.

Abnormality Judgment:

- Continue for 5 seconds.

Troubleshooting



Caution

For safety reason and to prevent component breakdown, always switch off the power before remove and connect the component.

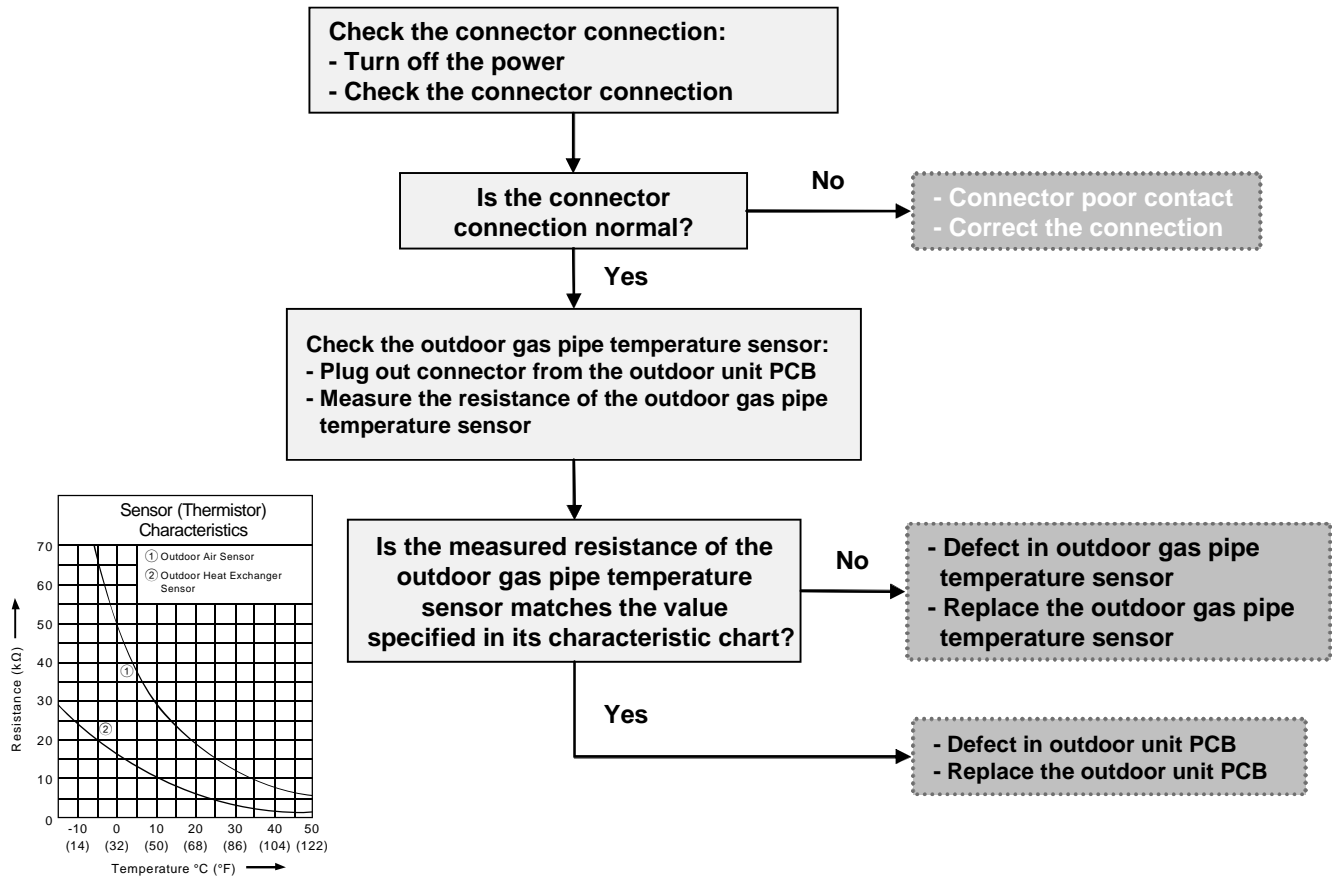

15.2.10 H37 (Outdoor Liquid Pipe Temperature Sensor Abnormality)

Malfunction Decision Conditions

- During startup and operation of cooling and heating, the temperatures detected by the outdoor liquid pipe temperature sensor are used to determine sensor errors.

Malfunction Caused

- Faulty connector connection.
- Faulty sensor.
- Faulty PCB.

Abnormality Judgment:

- Continue for 5 seconds.

Troubleshooting



Caution

For safety reason and to prevent component breakdown, always switch off the power before remove and connect the component.

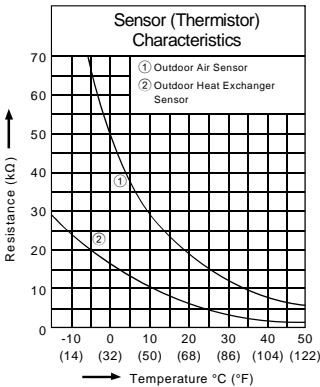
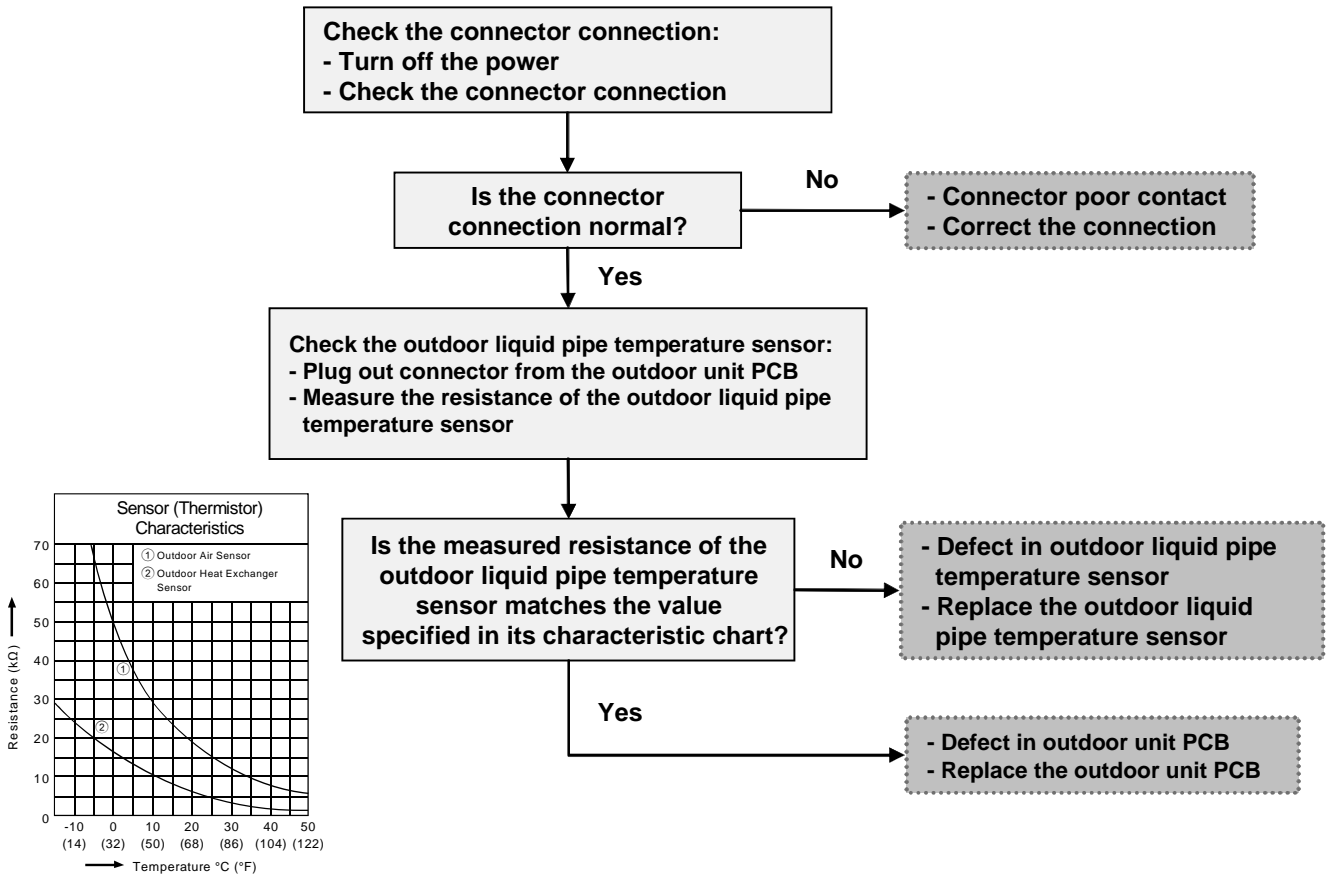

15.2.11 H97 (Outdoor Fan Motor Mechanism Locked)

Malfunction Decision Conditions

- The rotation speed detected by the Hall IC during fan motor operation is used to determine abnormal fan motor.

Malfunction Caused

- Operation stop due to short circuit inside the fan motor winding.
- Operation stop due to breaking of wire inside the fan motor.
- Operation stop due to breaking of fan motor lead wires.
- Operation stop due to Hall IC malfunction.
- Operation error due to faulty outdoor unit PCB.

Abnormality Judgment:

- 2 times happen within 30 minutes.

Troubleshooting

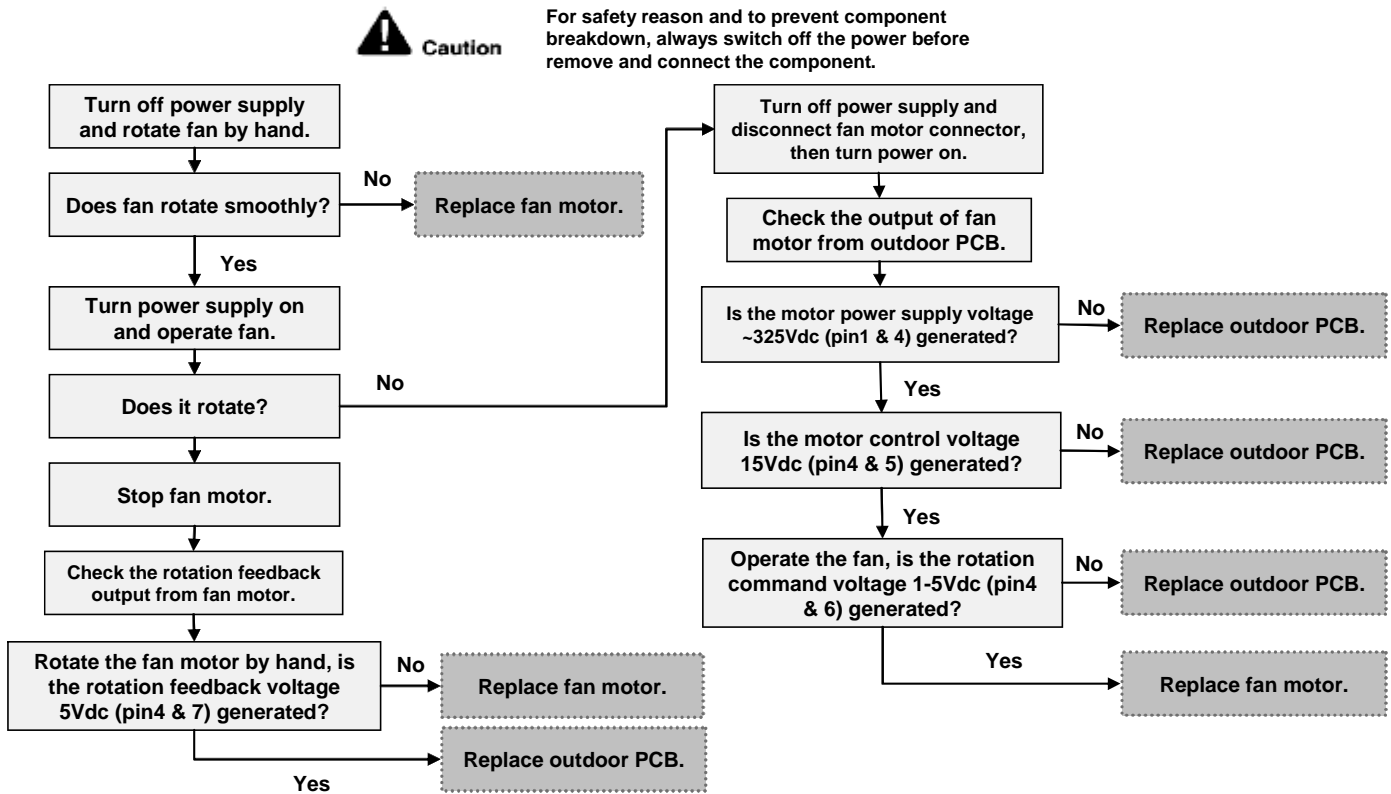

15.2.12 H98 (Indoor High Pressure Protection)

Malfunction Decision Conditions

- During heating operation, the temperature detected by the indoor pipe temperature sensor is above 60°C (140°F).

Malfunction Caused

- Clogged air filter of the indoor unit.
- Dust accumulation on the indoor unit heat exchanger.
- Air short circuit.
- Detection error due to faulty indoor pipe temperature sensor.
- Detection error due to faulty indoor unit PCB.

Troubleshooting

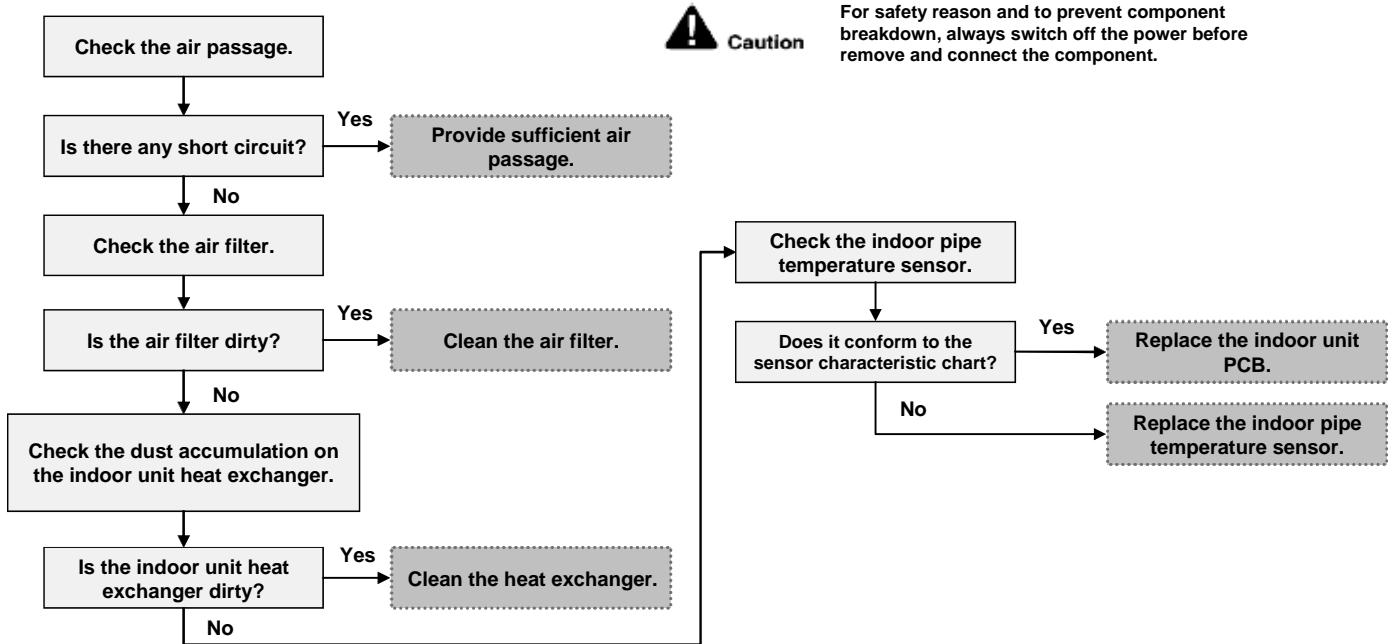

15.2.13 H99 (Indoor Operating Unit Freeze Protection)

Malfunction Decision Conditions

- During cooling operation, anti-freezing control take place when indoor pipe temperature is lower than 0°C (32°F).

Malfunction Caused

- Clogged air filter of the indoor unit.
- Dust accumulation on the indoor unit heat exchanger.
- Air short circuit.
- Detection error due to faulty indoor pipe temperature sensor.
- Detection error due to faulty indoor unit PCB.

Troubleshooting

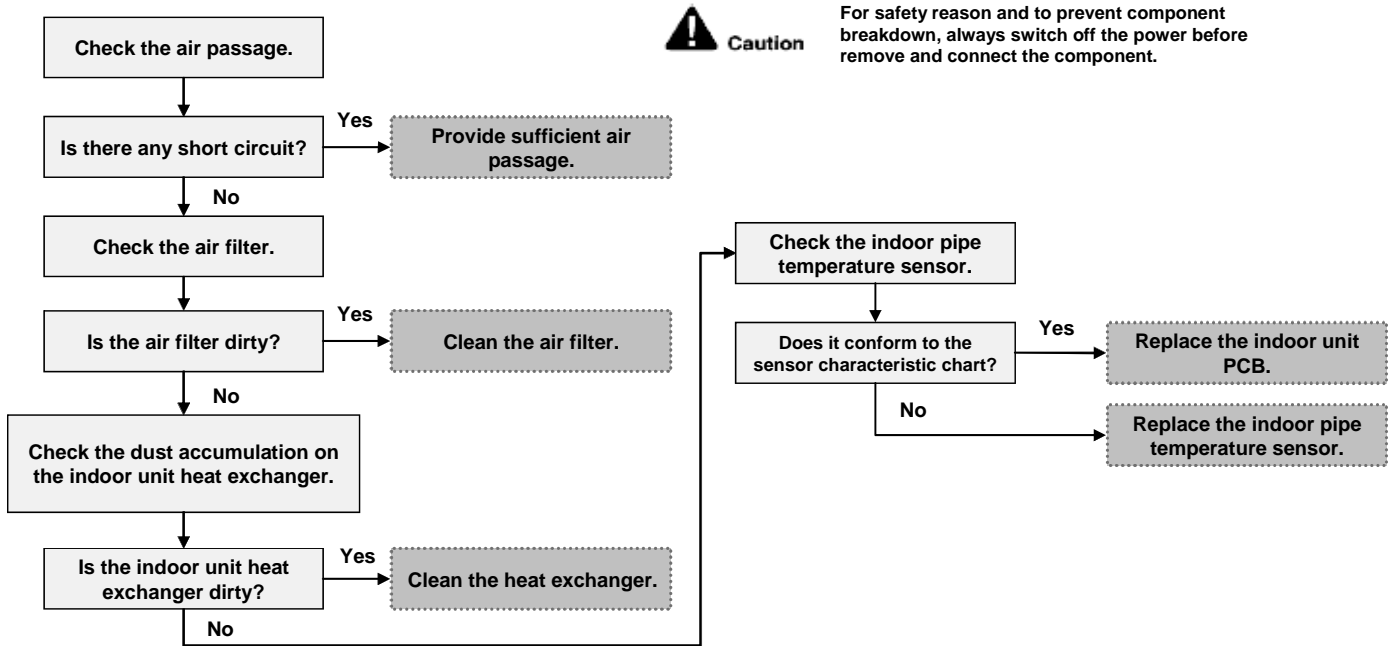

15.2.14 F11 (4-Way Valve Switching Abnormality)

Malfunction Decision Conditions

- During heating operation, when (liquid pipe temperature – outdoor pipe temperature) is below -5°C (23°F).
- During cooling operation, when (outdoor pipe temperature – liquid pipe temperature) is below -5°C (23°F).

Malfunction Caused

- Connector in poor contact.
- Faulty sensor.
- Faulty outdoor unit PCB.
- Four way valve defective.

Abnormality Judgment:

- 4 times happen within 30 minutes.

Troubleshooting

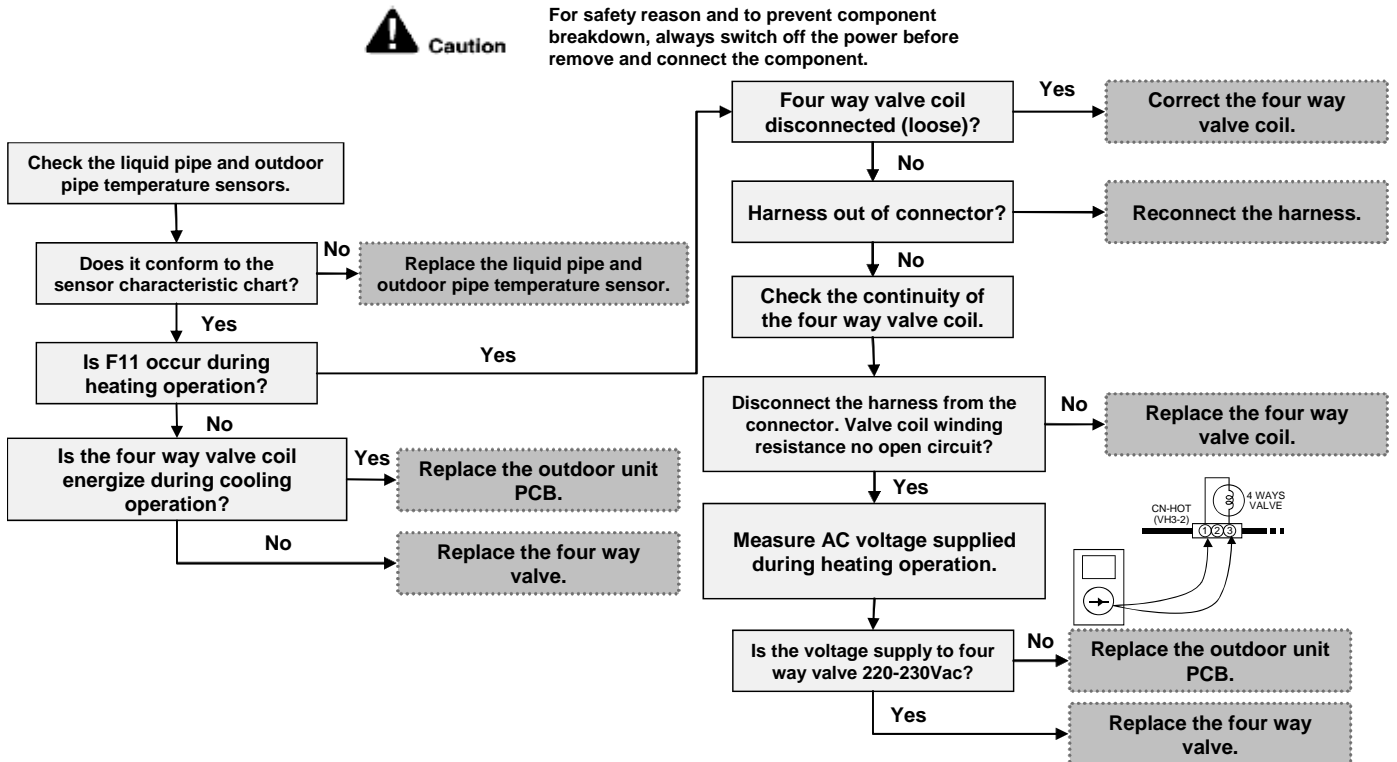

15.2.15 F17 (Indoor Standby Units Freezing Abnormality)

Malfunction Decision Conditions

- When the difference between indoor intake air temperature and indoor pipe temperature is above 10°C (50°F) or indoor pipe temperature is below -1.0°C (30.2°F).

Malfunction Caused

- Wrong wiring connection.
- Faulty sensor.
- Faulty expansion valve.

Abnormality Judgment:

- 3 times happen within 40 minutes.

Troubleshooting



Caution

For safety reason and to prevent component breakdown, always switch off the power before remove and connect the component.

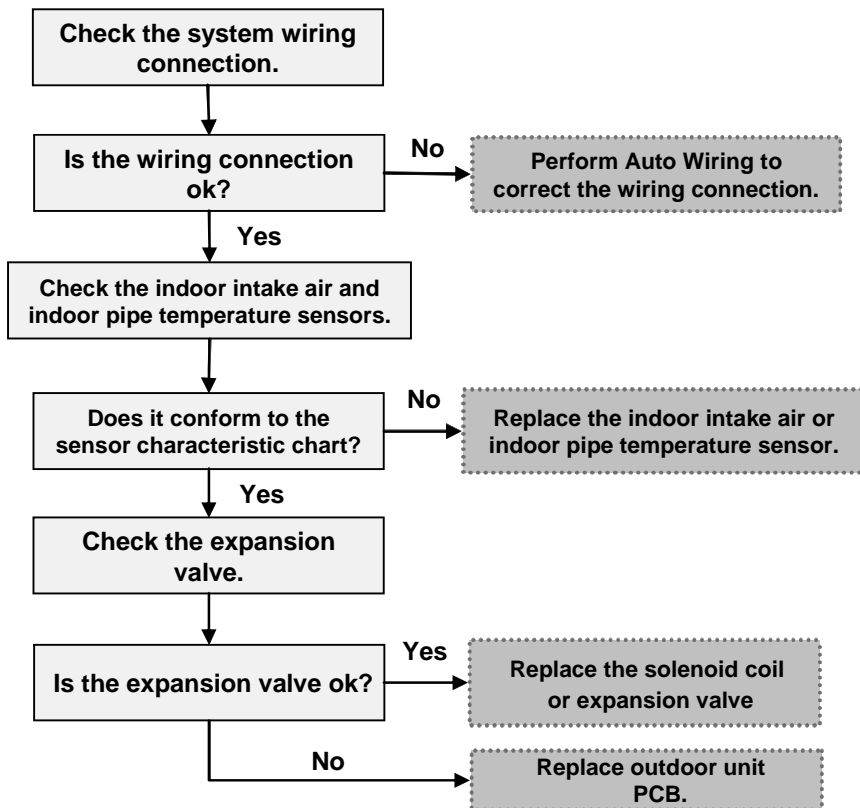

Electronic Expansion Valve Check

Conduct the following check points:

- Check if expansion valve connector is properly inserted and v-coil is properly latched to the valve.
- Turn on the power and check if latching sound is generated (touch the valve with a screw driver and bring it closer to your ear).
- If latching sound is not generated, remove the connector and check v-coil conductivity between pin 1 and other pins (~50ohm) and between each pins (~90ohm).
- If v-coil has no conductivity, v-coil is faulty.
- If v-coil has conductivity, mount good v-coil.
- If still no latching, then replace the valve unit or replace outdoor control PCB.

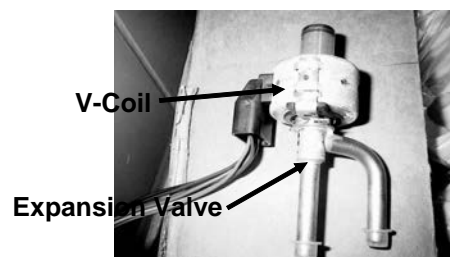
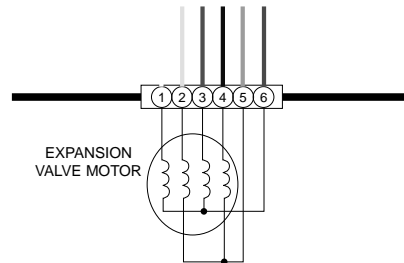

15.2.16 F90 (Power Factor Correction (PFC) Circuit Protection)

Malfunction Decision Conditions

- During startup and operation of cooling and heating, when PFC protection circuitry at the outdoor unit main PCB senses low DC voltage level (below 280Vdc).

Malfunction Caused

- Low DC voltage due to power supply drop.
- Low DC voltage due to compressor windings not uniform.
- Reactor connection is disconnected.
- Faulty outdoor unit PCB.

Abnormality Judgment:

- 4 times happen within 20 minutes.

Troubleshooting

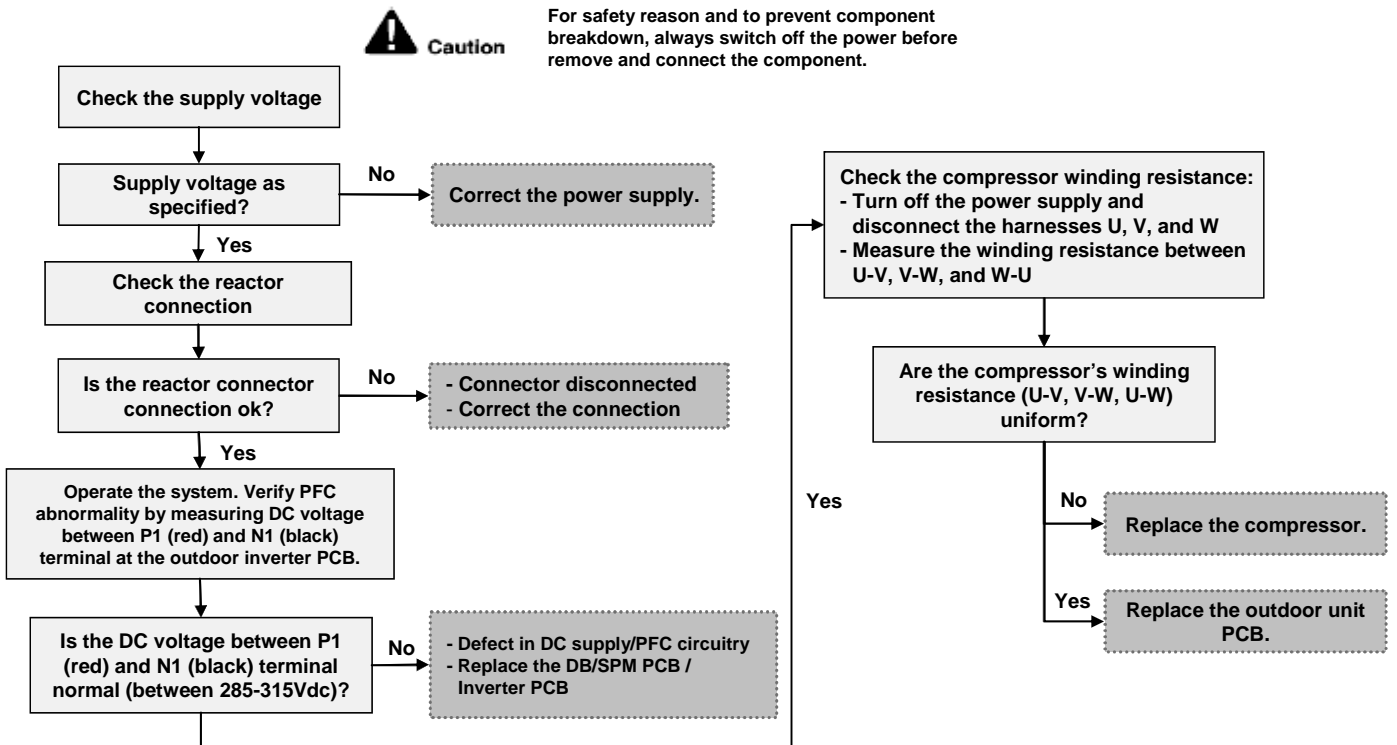

15.2.17 F91 (Refrigeration Cycle Abnormality)

Malfunction Decision Conditions

- *Gas shortage detection I:* A gas shortage is detected by checking the CT-detected input current value and the compressor running frequency. During startup and operating of cooling and heating, input current $< 8.78/256$ (A/Hz) x compressor running frequency + 0.25.
- *Gas shortage detection II:* A gas shortage is detected by checking the difference between indoor pipe temperature and indoor intake air temperature during cooling and heating.

Malfunction Caused

- Refrigerant shortage (refrigerant leakage).
- Poor compression performance of compressor.
- 2/3 way valve closed.
- Detection error due to faulty indoor intake air and indoor pipe temperature sensors.

Abnormality Judgment:

- 4 times happen within 60 minutes.

Troubleshooting



Caution

For safety reason and to prevent component breakdown, always switch off the power before remove and connect the component.

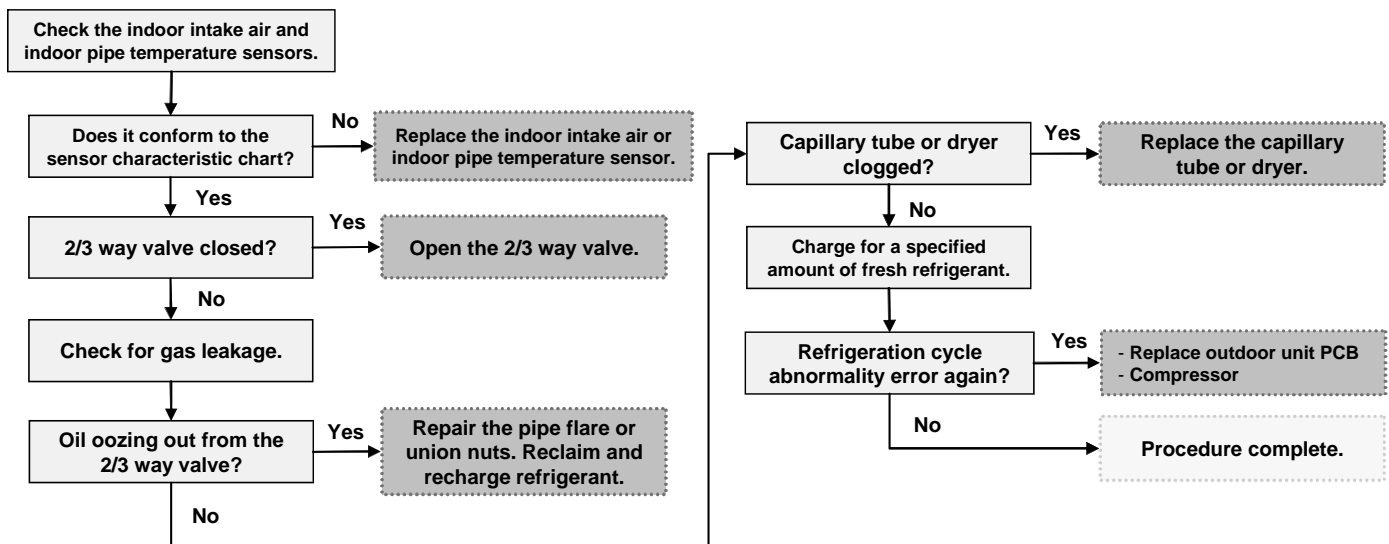

15.2.18 F93 (Compressor Abnormal Revolution)

Malfunction Decision Conditions

- A compressor rotation failure is detected by checking the compressor running condition through the position detection circuit.

Malfunction Caused

- Compressor terminal disconnect.
- Outdoor PCB malfunction.

Abnormality Judgment:

- 4 times happen within 20 minutes.

Troubleshooting



Caution

For safety reason and to prevent component breakdown, always switch off the power before remove and connect the component.

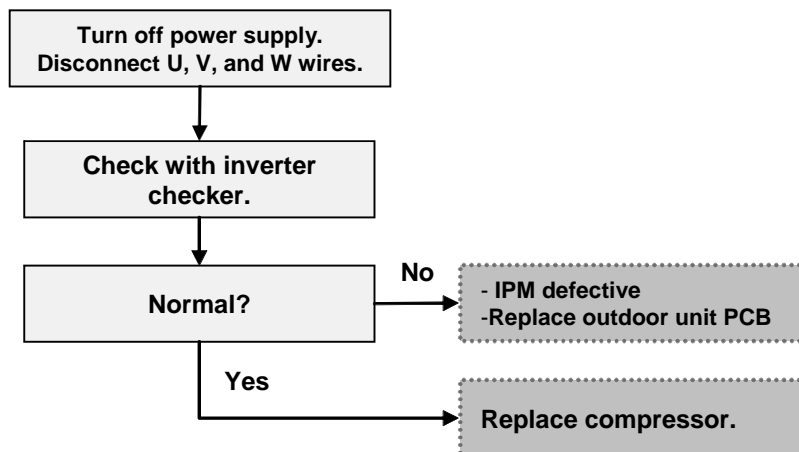

15.2.19 F94 (Compressor Discharge Pressure Overshoot Protection)

Malfunction Decision Conditions

- During operation of cooling and heating, when the outdoor unit high pressure switch is open (4.15MPa and above).

Malfunction Caused

- Clogged air filter of indoor unit.
- Dust accumulation on the indoor/outdoor unit heat exchanger.
- Air short circuit at indoor/outdoor unit.
- 3 way valve closed.
- Faulty outdoor unit fan motor.
- Excess refrigerant.
- Clogged expansion valve or strainer.
- Faulty outdoor unit high pressure switch.
- Faulty outdoor unit PCB (main).

Abnormality Judgment:

- 4 times happen within 30 minutes.

Troubleshooting



Caution

For safety reason and to prevent component breakdown, always switch off the power before remove and connect the component.

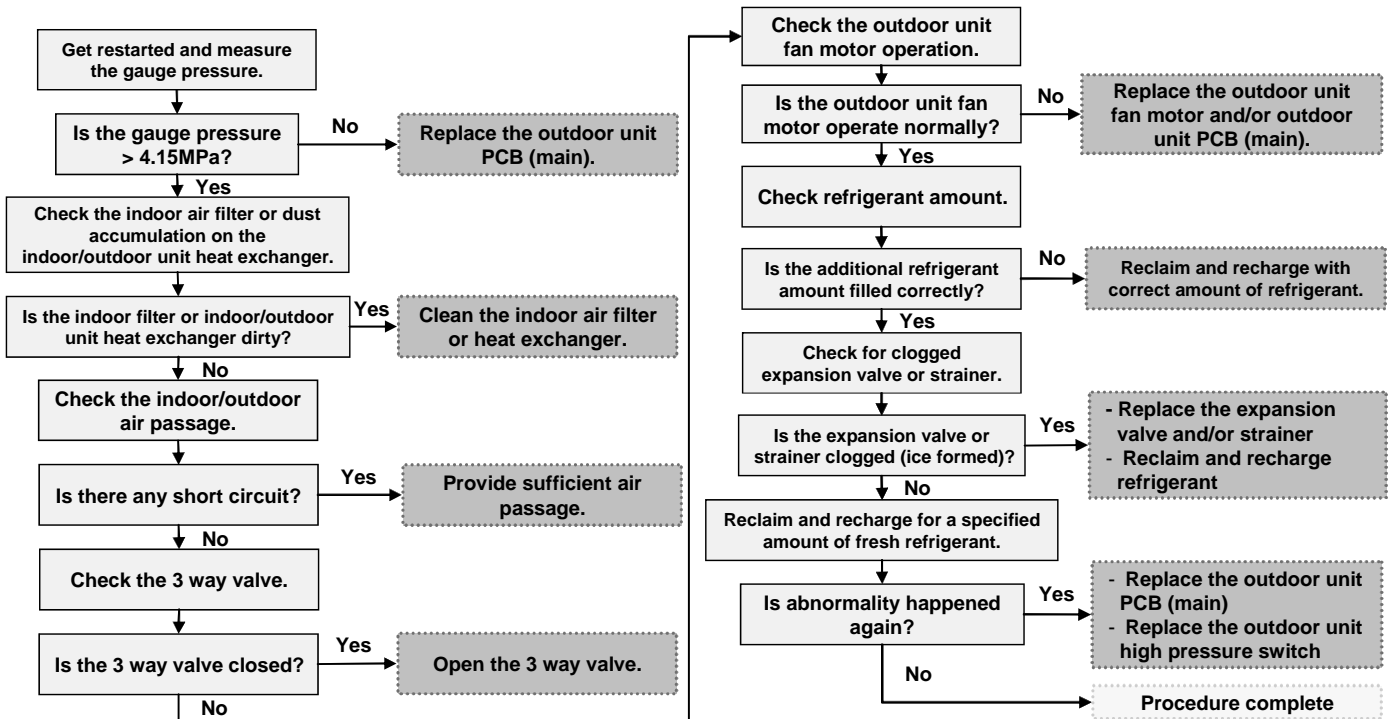

15.2.20 F96 (Power Transistor Module Overheating Protection)

Malfunction Decision Conditions

- Compressor Overheating: During operation of cooling and heating, when the compressor OL is activated.
- Heat Sink Overheating: During operation of cooling and heating, when heat sink temperature data (90°C (194°F)) is detected by the heat sink temperature sensor.

Malfunction Caused

- Compressor OL connector poor contact.
- Compressor OL faulty.
- IPM overheat due to short circuit of hot discharge air flow.
- IPM overheat due to defective of outdoor fan motor.
- IPM overheat due to defective of internal circuitry of IPM.
- IPM overheat due to defective IPM temperature sensor.

Abnormality Judgment:

- 4 times happen within 30 minutes.

Troubleshooting



Caution

For safety reason and to prevent component breakdown, always switch off the power before remove and connect the component.

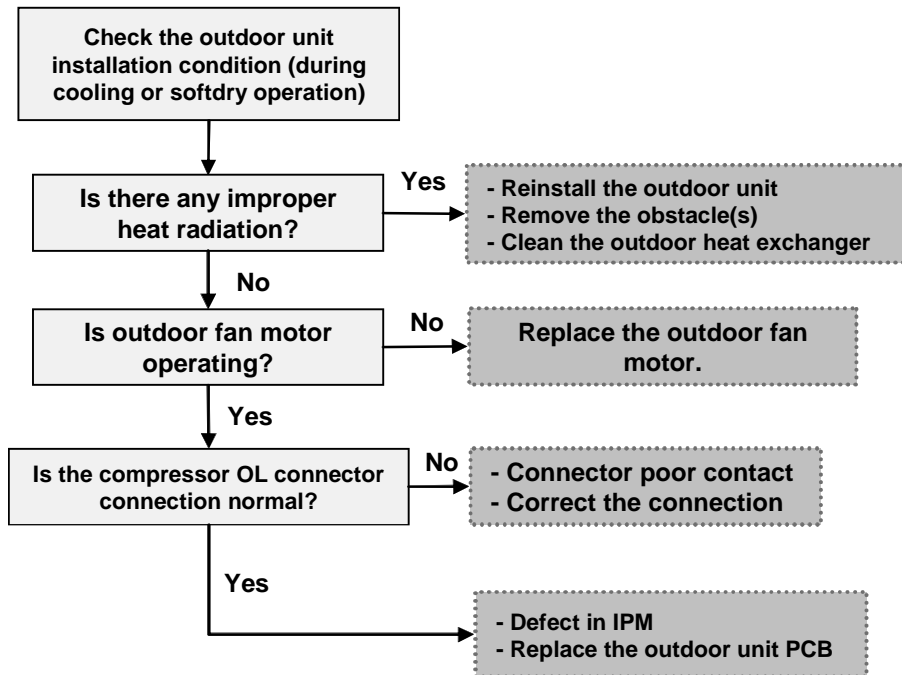

15.2.21 F97 (Compressor Overheating Protection)

Malfunction Decision Conditions

- During operation of cooling and heating, when compressor discharge pipe temperature data (120°C (248°F)) is detected by the compressor discharge pipe temperature sensor.

Malfunction Caused

- Refrigerant shortage (refrigerant leakage).
- 2/3 way valve closed.
- Detection error due to faulty compressor discharge pipe temperature sensor.

Abnormality Judgment:

- 3 times happen within 30 minutes.

Troubleshooting



Caution

For safety reason and to prevent component breakdown, always switch off the power before remove and connect the component.

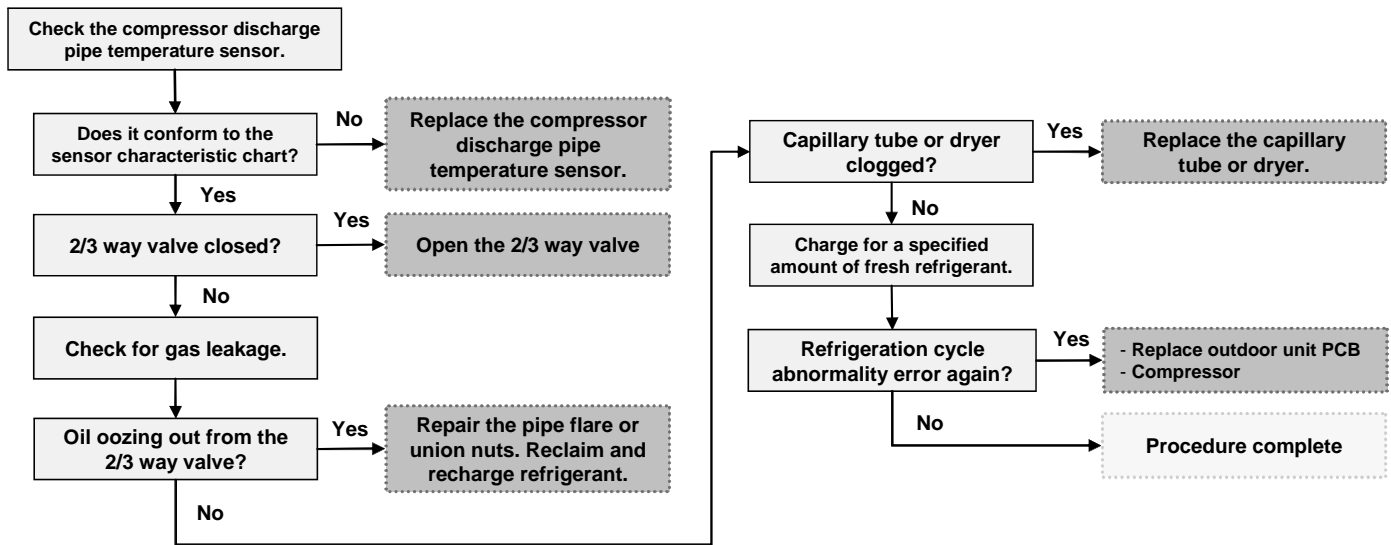

15.2.22 F98 (Total Running Current Protection)

Malfunction Decision Conditions

- During operation of cooling and heating, when an input over-current (20.0A) is detected by checking the input current value being detected by current transformer (CT) with the compressor running.

Malfunction Caused

- Over-current due to compressor failure.
- Over-current due to defective outdoor unit PCB.
- Over-current due to defective inverter main circuit electrolytic capacitor.
- Over-current due to excessive refrigerant.

Abnormality Judgment:

- 3 times happen within 20 minutes.

Troubleshooting



Caution

For safety reason and to prevent component breakdown, always switch off the power before remove and connect the component.

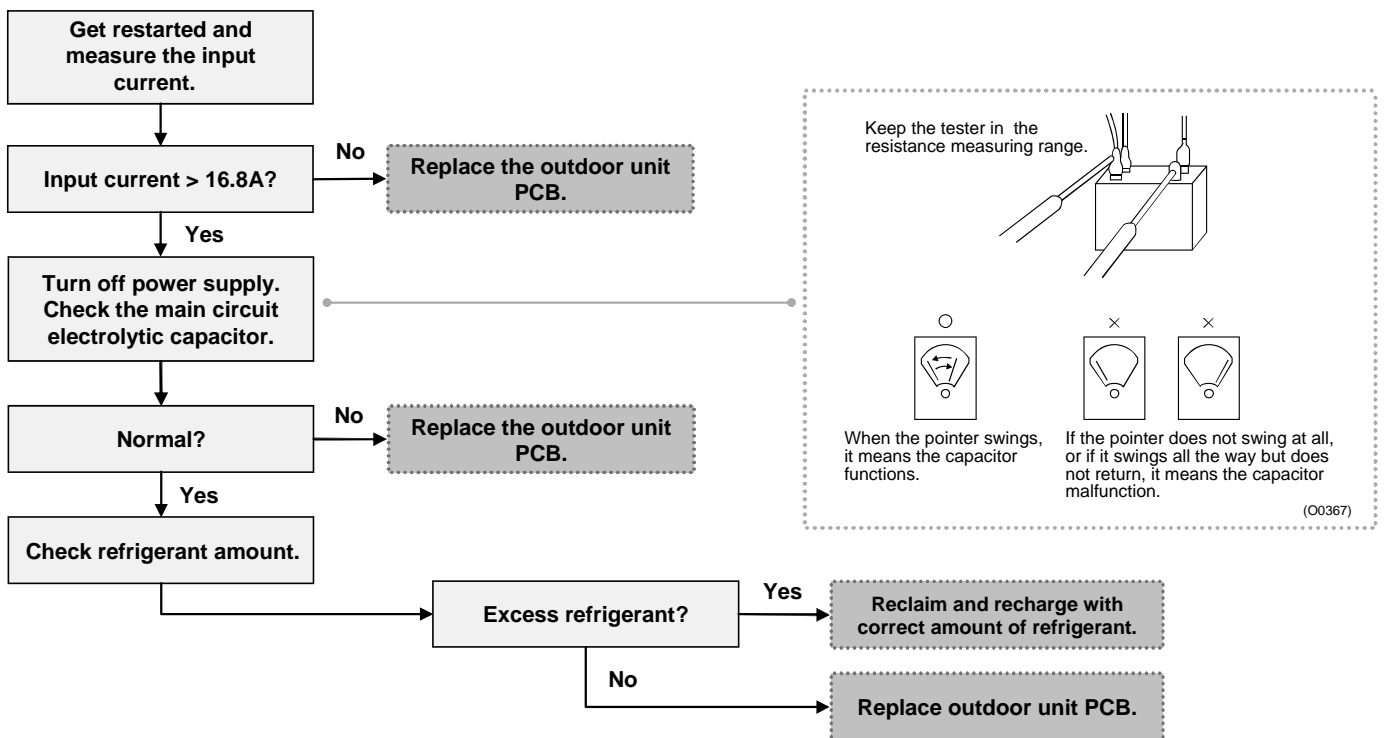

15.2.23 F99 (Outdoor Direct Current (DC) Peak Protection)

Malfunction Decision Conditions

- During operation of cooling and heating, when an output over-current is detected by checking the current that flows in the inverter DC Peak sensing circuitry.

Malfunction Caused

- DC peak due to compressor failure.
- DC peak due to defective power transistor(s).
- DC peak due to defective outdoor unit PCB.

Abnormality Judgment:

- Continuous happen for 7 times.

Troubleshooting



For safety reason and to prevent component breakdown, always switch off the power before remove and connect the component.

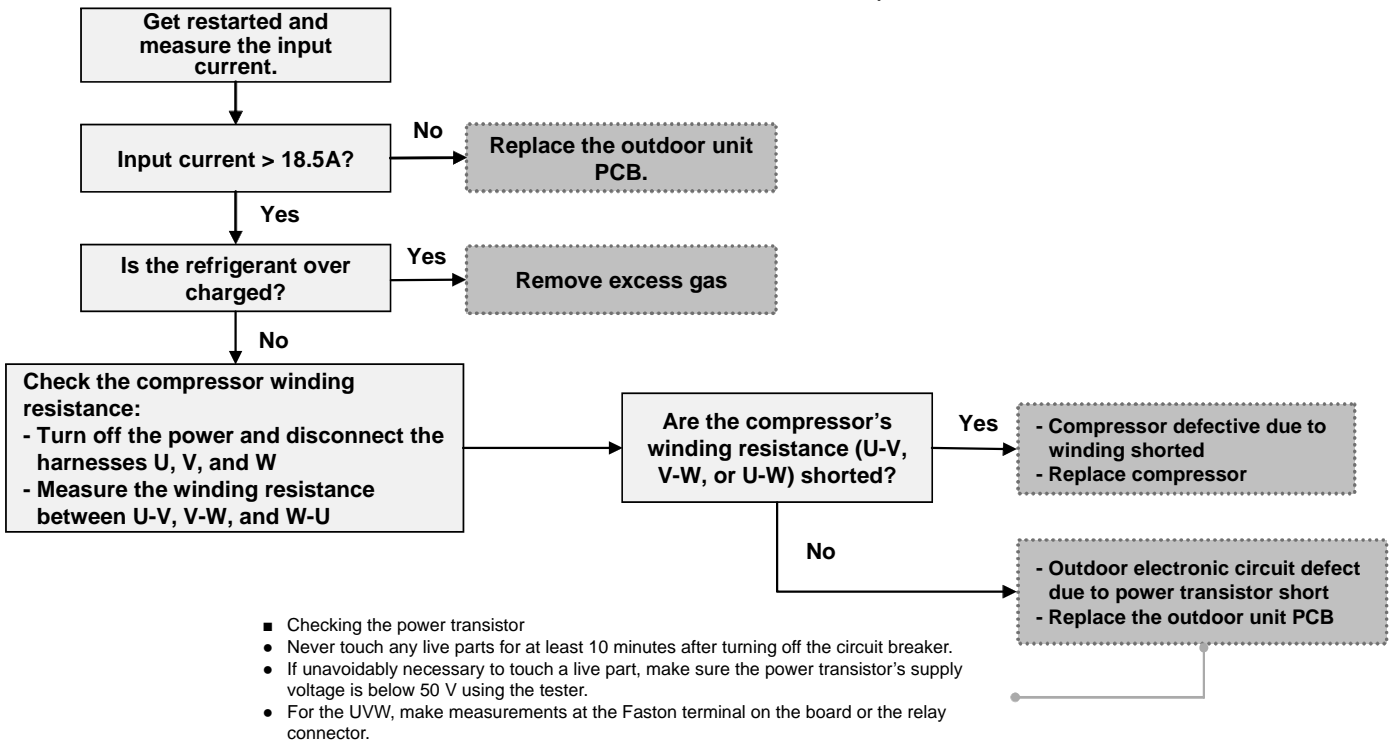

Tester's negative terminal	Power transistor (+)	UVW	Power transistor (-)	UVW
Tester's positive terminal	UVW	Power transistor (+)	UVW	Power transistor (-)
Normal resistance	Several kΩ to several MΩ			
Abnormal resistance	0 or ∞			

16. Disassembly and Assembly Instructions



High voltages are generated in the electrical parts area by the capacitor. Ensure that the capacitor has discharged sufficiently before proceeding with repair work. Failure to heed this caution may result in electric shocks.

16.1 Outdoor Unit Removal Procedure (CU-3E19RBU)

Caution! When handling electronic controller, be careful of electrostatic discharge.

16.1.1 Removing the Cabinet Top Plate and Cabinet Front Plate

1. Remove the cabinet top plate (remove the 8 screws).
2. Remove the 8 screws (1 on the center, 3 at the top and 4 at the bottom) securing the cabinet front plate, release the 2 hooks (1 each at the left and right), and pull the cabinet front plate toward front side.

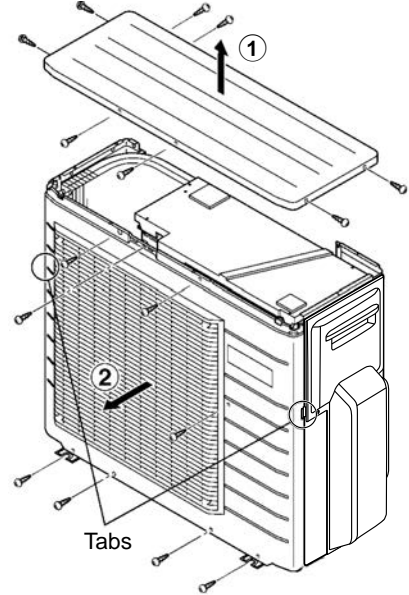

16.1.2 Remove the Control Board Cover and Particular Plates

3. Remove the control board cover (remove 3 screws).
4. Remove the particular plate (remove 2 screws).
5. Remove the particular plate (remove 2 screws).

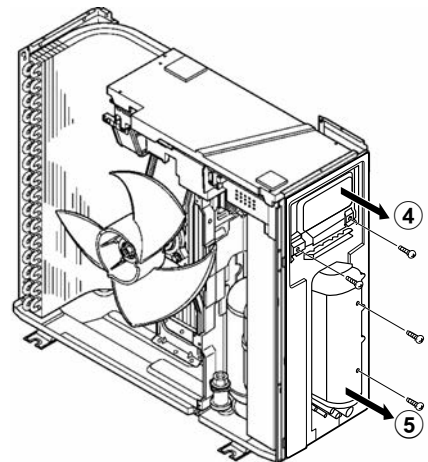
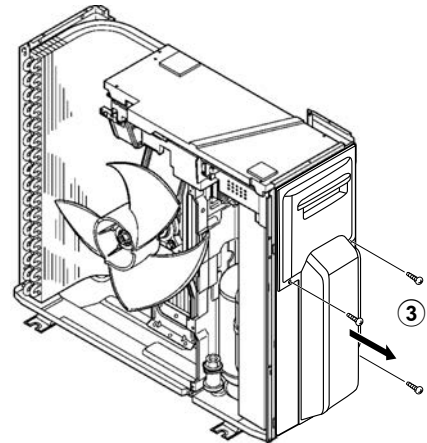

16.1.3 Removing the Control P.C. Board

6. Remove the drip proof cover.
7. Disconnect the connectors (lead wires of the compressor, sensor, and others).
8. Remove the screw at the right side of the control box, and pull out the entire control box.
9. Release the control P.C. Board tab to remove the control P.C. Board.

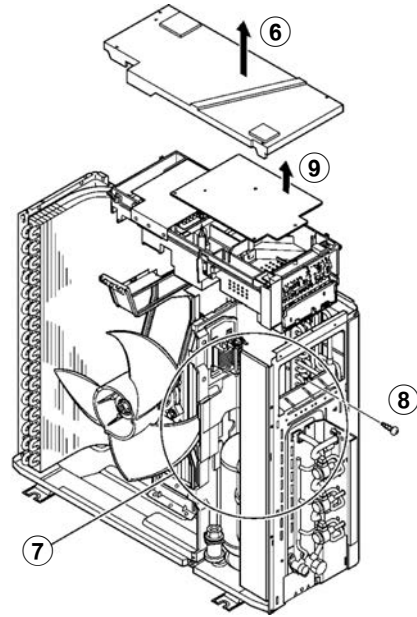

16.1.4 Removing the Propeller Fan and Fan Motor

1. Follow the steps in 16.1.1 for removing the cabinet top plate and cabinet front plate.
2. Remove the propeller fan by removing the nut turning clockwise at its center.

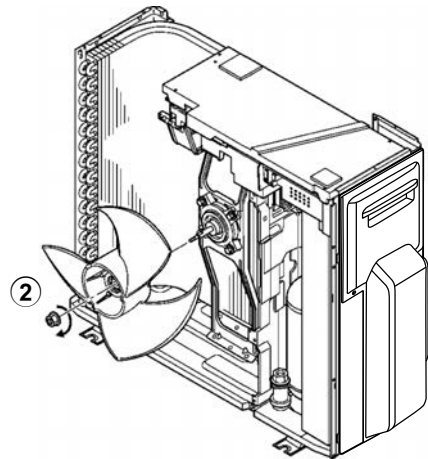

3. Disconnect the fan motor connector from the control P.C. Board.
4. Loosen the 4 fan motor mounting screws then remove the fan motor.

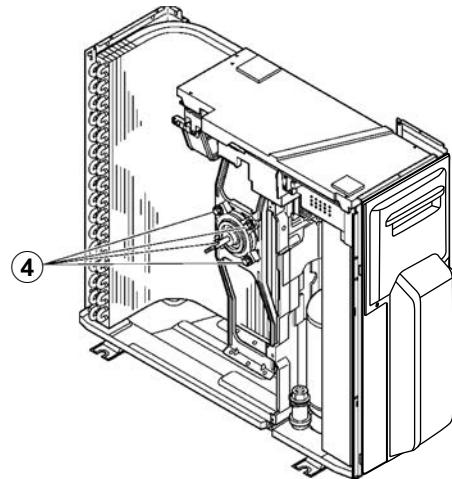

16.2 Outdoor Unit Removal Procedure (CU-4E24RBU)

⚠ Caution! When handling electronic controller, be careful of electrostatic discharge.

16.2.1 Removing the Cabinet Top Plate

1. Remove the cabinet top plate (remove the 11 screws).



Fig. 1

16.2.2 Remove the Control Board Cover and Particular Plates

2. Remove the control board cover (remove the 5 screws).



Fig. 2

3. Remove the particular plate (remove the 3 screws).



Fig. 3

4. Remove the particular plate (remove the 8 screws).



Fig. 4

16.2.3 Removing the Cabinet Front Plate

5. Remove the cabinet front plate (remove the 7 screws).



Fig. 5

16.2.4 Removing the Control P.C. Board

6. Remove the cover by release the screw.



Fig. 6

7. Disconnect the connectors (lead wires of the compressor, sensors, and others).
8. Release the Control P.C. Board tab to remove the Control P.C. Board.

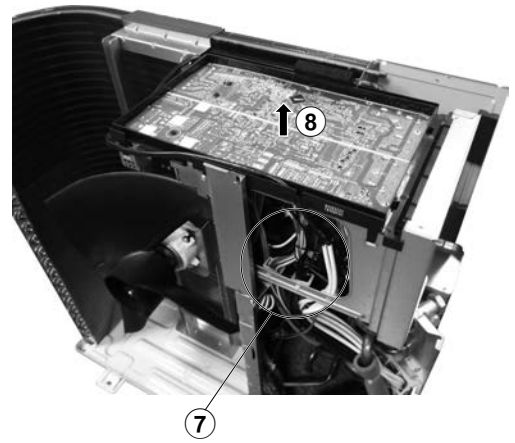

Fig. 7

16.2.5 Removing the Propeller Fan and Fan Motor

9. Remove the propeller fan by removing the nut turning clockwise as its center.
10. Disconnect the fan motor connector from the Control P.C. Board. Loosen the 4 fan motor mounting screws then remove the fan motor.

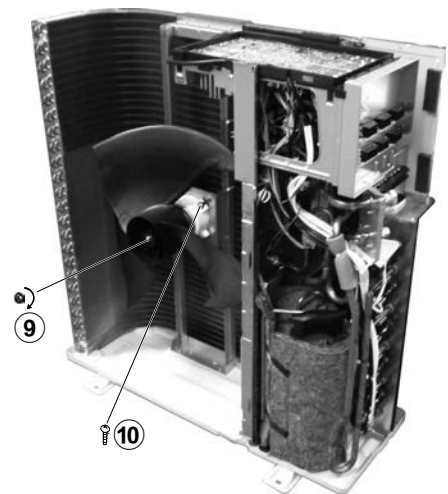

Fig. 8

17. Technical Data

17.1 CU-3E19RBU

17.1.1 Operation Characteristics

17.1.1.1 One Indoor Unit Operation

- Cooling Characteristic

[Condition] Room temperature: 80.0°F (26.7°C) (DBT), 67.0°F (19.4°C) (WBT)

Operation condition: High fan speed

Piping Length: 7.5m (24.6 ft)

230V 60Hz

A) Indoor unit capacity: Cooling (2.0: CS-ME7RKUA), service mode frequency = 32Hz

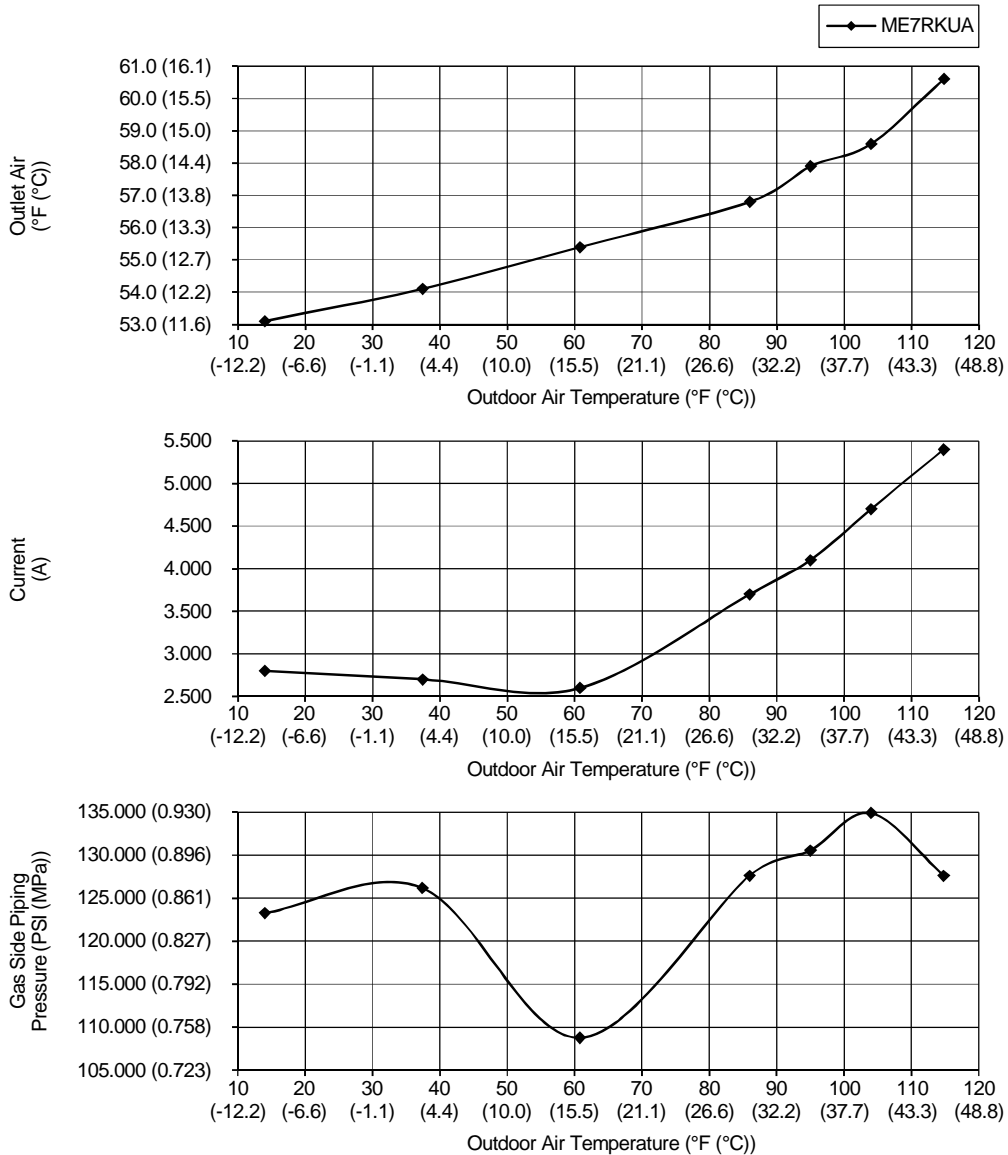

- Cooling Characteristic

[Condition] Room temperature: 80.0°F (26.7°C) (DBT), 67.0°F (19.4°C) (WBT)

Operation condition: High fan speed

Piping Length: 7.5m (24.6 ft)

230V 60Hz

B) Indoor unit capacity: Cooling (2.5: CS-E9RKUAW), service mode frequency = 32Hz

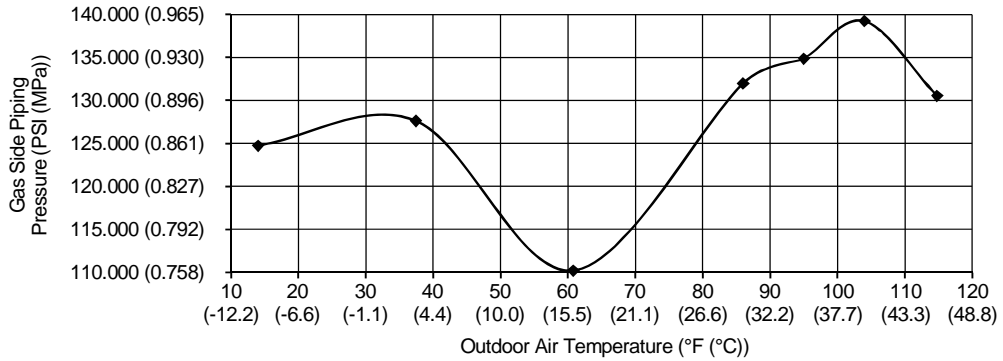
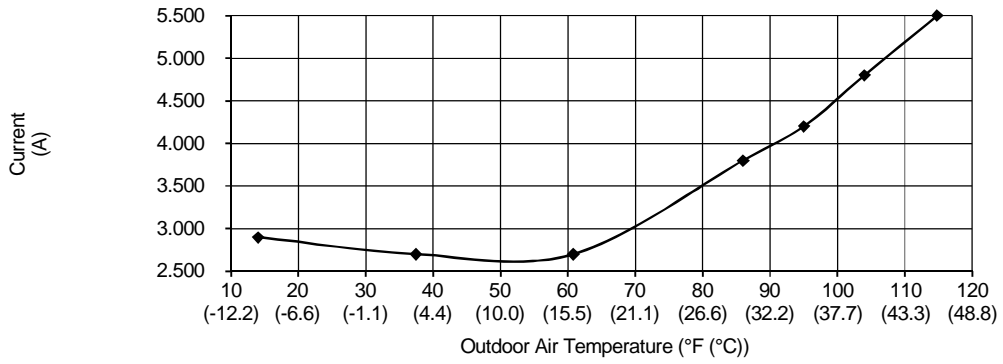
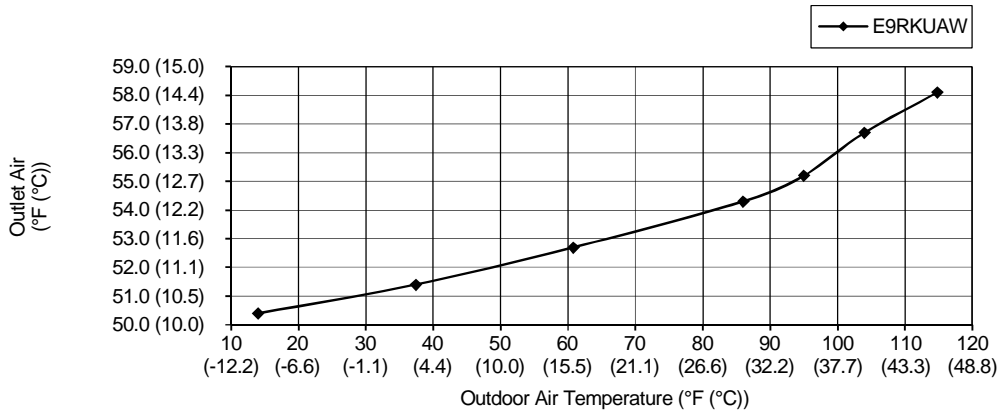

- Cooling Characteristic

[Condition] Room temperature: 80.0°F (26.7°C) (DBT), 67.0°F (19.4°C) (WBT)

Operation condition: High fan speed

Piping Length: 7.5m (24.6 ft)

230V 60Hz

C) Indoor unit capacity: Cooling (3.2: CS-E12RKUAW), service mode frequency = 35Hz

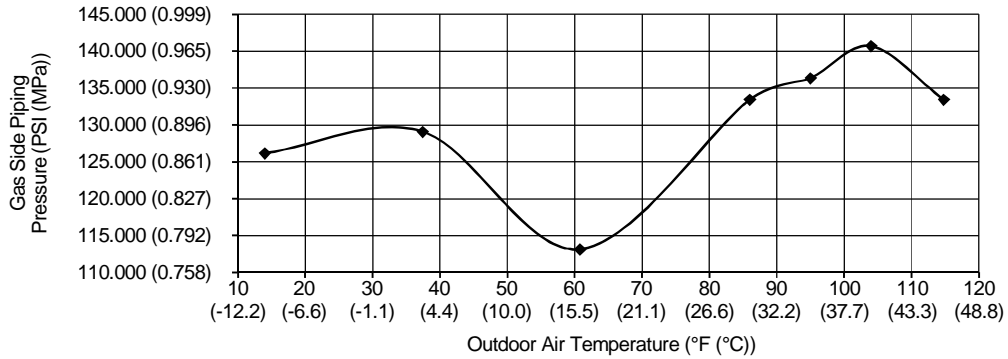
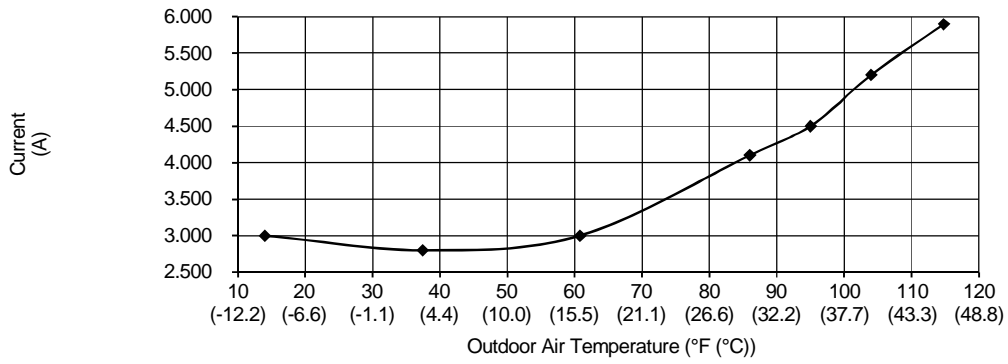
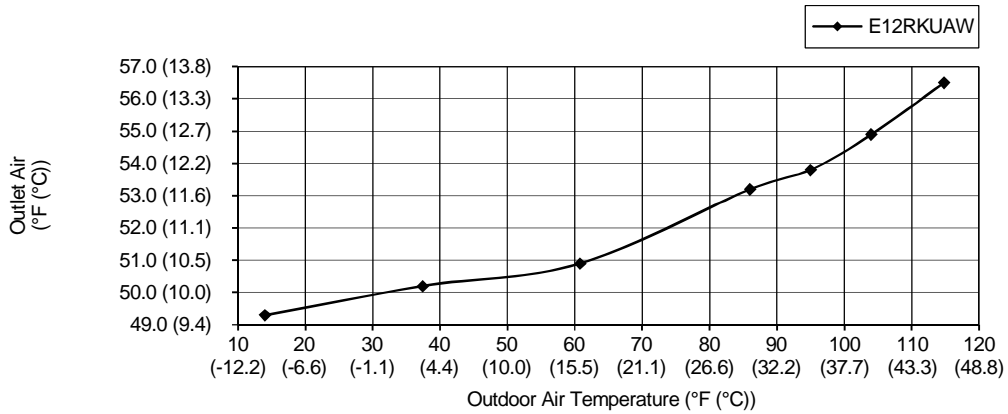

- Heating Characteristic

[Condition] Room temperature: 70.0°F (21.1°C) (DBT), 60.0°F (15.6°C) (WBT)

Operation condition: High fan speed

Piping Length: 7.5m (24.6 ft)

230V 60Hz

A) Indoor unit capacity: Heating (2.0: CS-ME7RKUA), service mode frequency = 49Hz

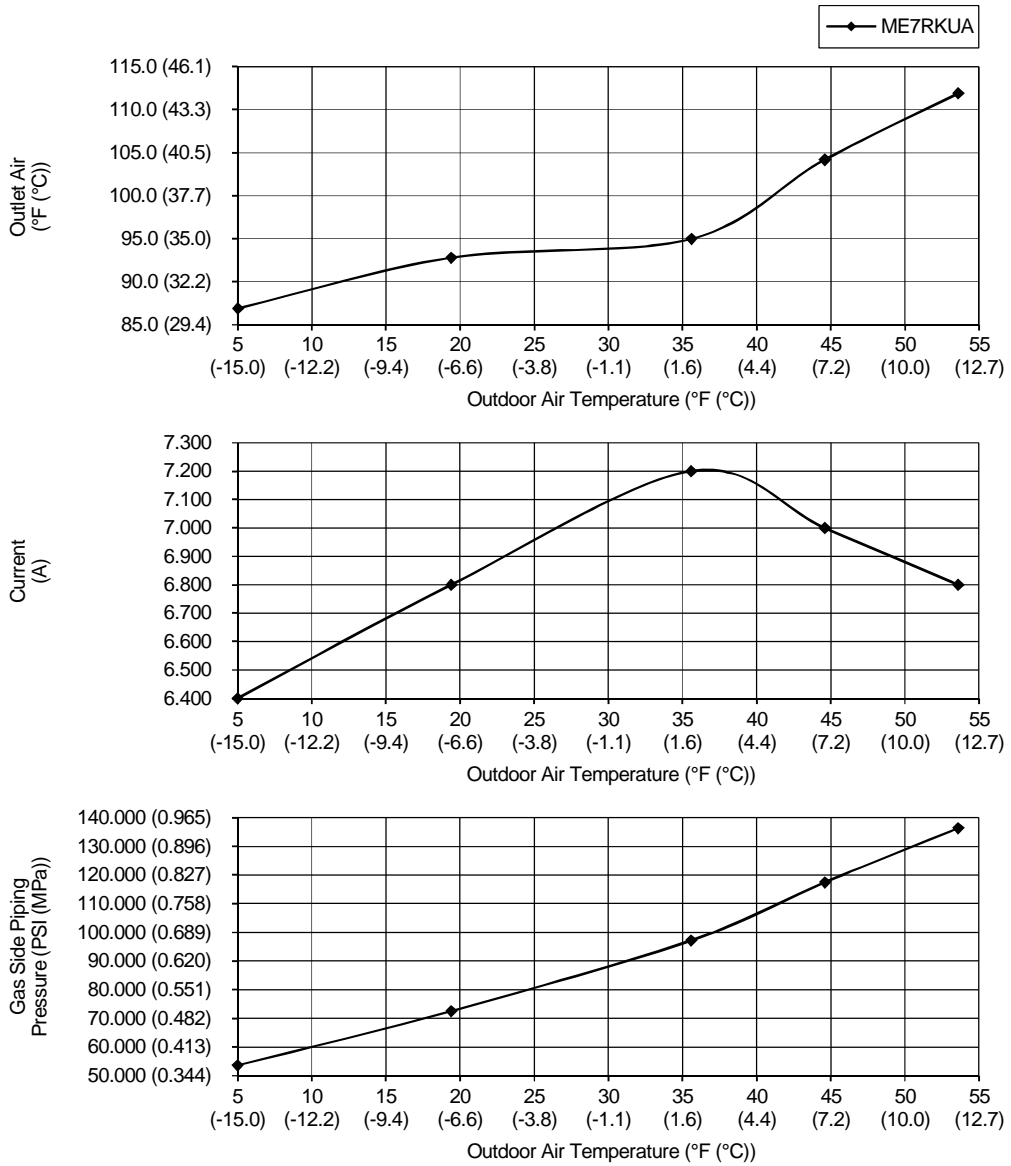

44.6°F & 53.6°F (Outdoor Air Temp.) = Heating Overload Protection activated

- Heating Characteristic

[Condition] Room temperature: 70.0°F (21.1°C) (DBT), 60.0°F (15.6°C) (WBT)

Operation condition: High fan speed

Piping Length: 7.5m (24.6 ft)

230V 60Hz

B) Indoor unit capacity: Heating (2.5: CS-E9RKUAW), service mode frequency = 49Hz

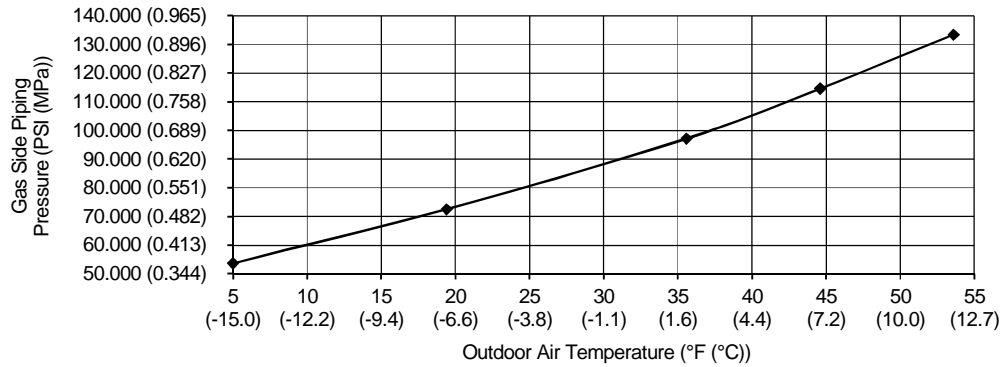
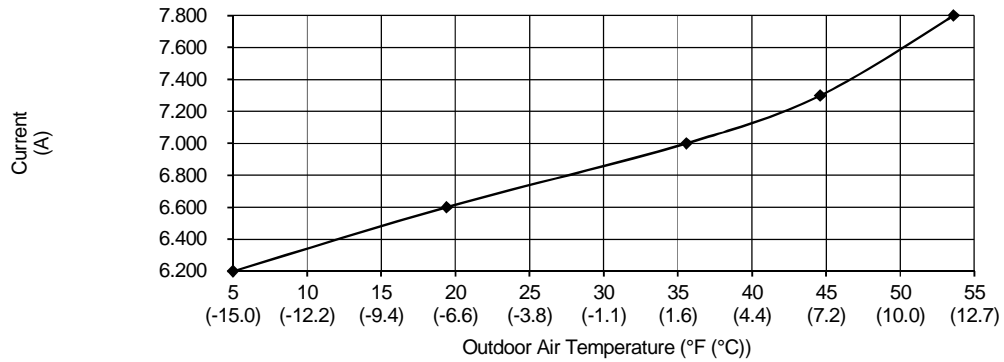
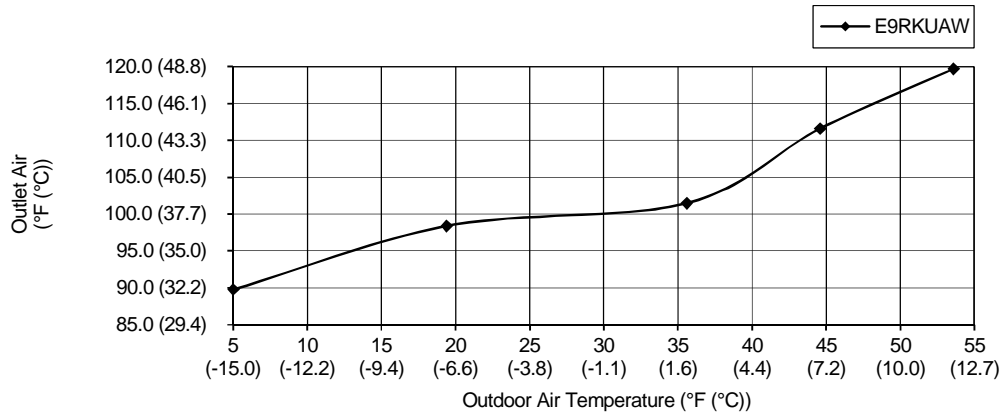

- Heating Characteristic

[Condition] Room temperature: 70.0°F (21.1°C) (DBT), 60.0°F (15.6°C) (WBT)

Operation condition: High fan speed

Piping Length: 7.5m (24.6 ft)

230V 60Hz

C) Indoor unit capacity: Heating (3.2: CS-E12RKUAW), service mode frequency = 49Hz

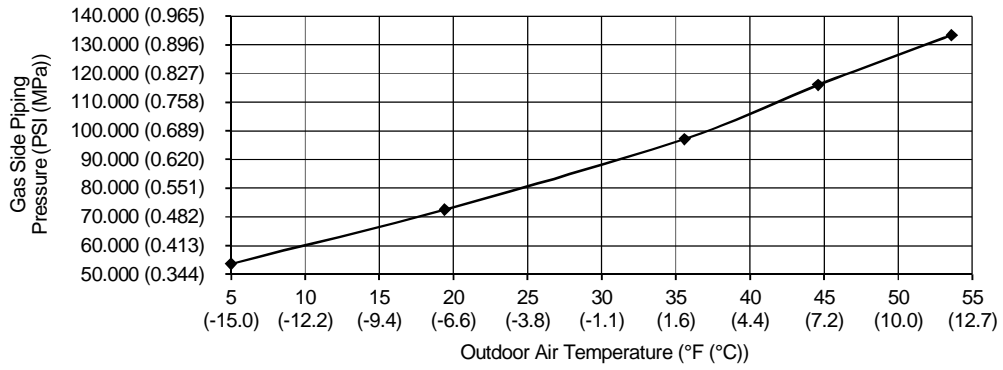
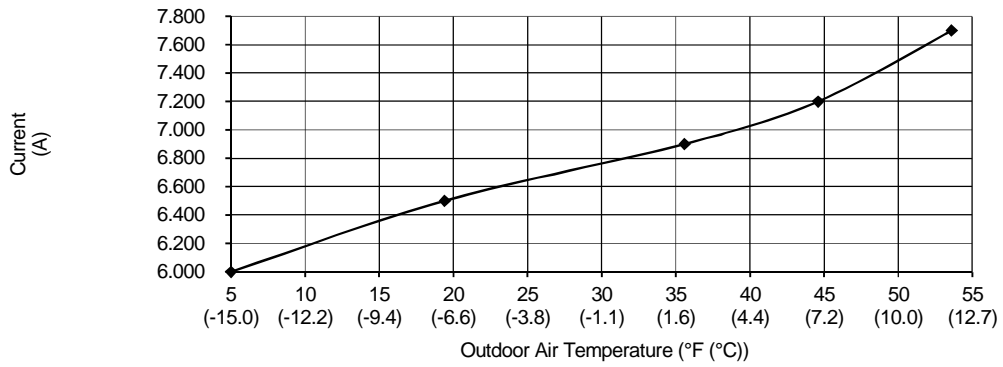
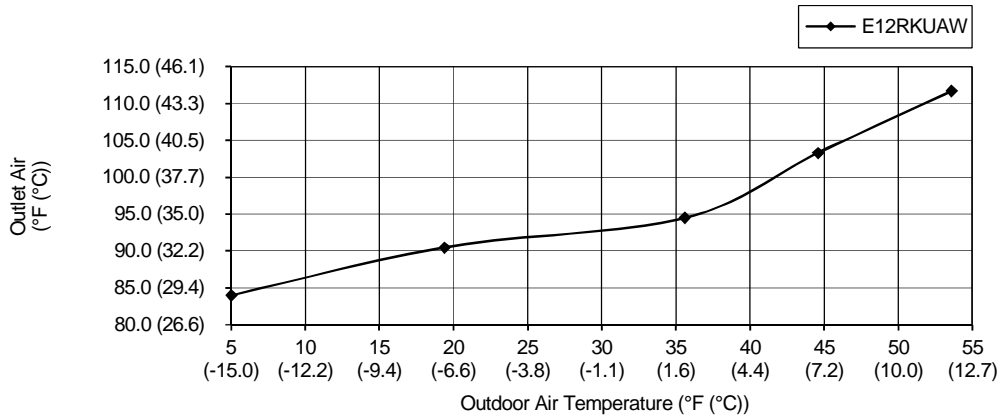

17.1.1.2 Two Indoor Unit Operation

- Cooling Characteristic

[Condition] Room temperature: 80.0°F (26.7°C) (DBT), 67.0°F (19.4°C) (WBT)

Operation condition: High fan speed

Piping Length: 7.5m (24.6 ft)

230V 60Hz

A) Indoor unit capacity: Cooling (3.2 + 2.5: CS-E12RKUAW + CS-E9RKUAW), service mode frequency = 42Hz

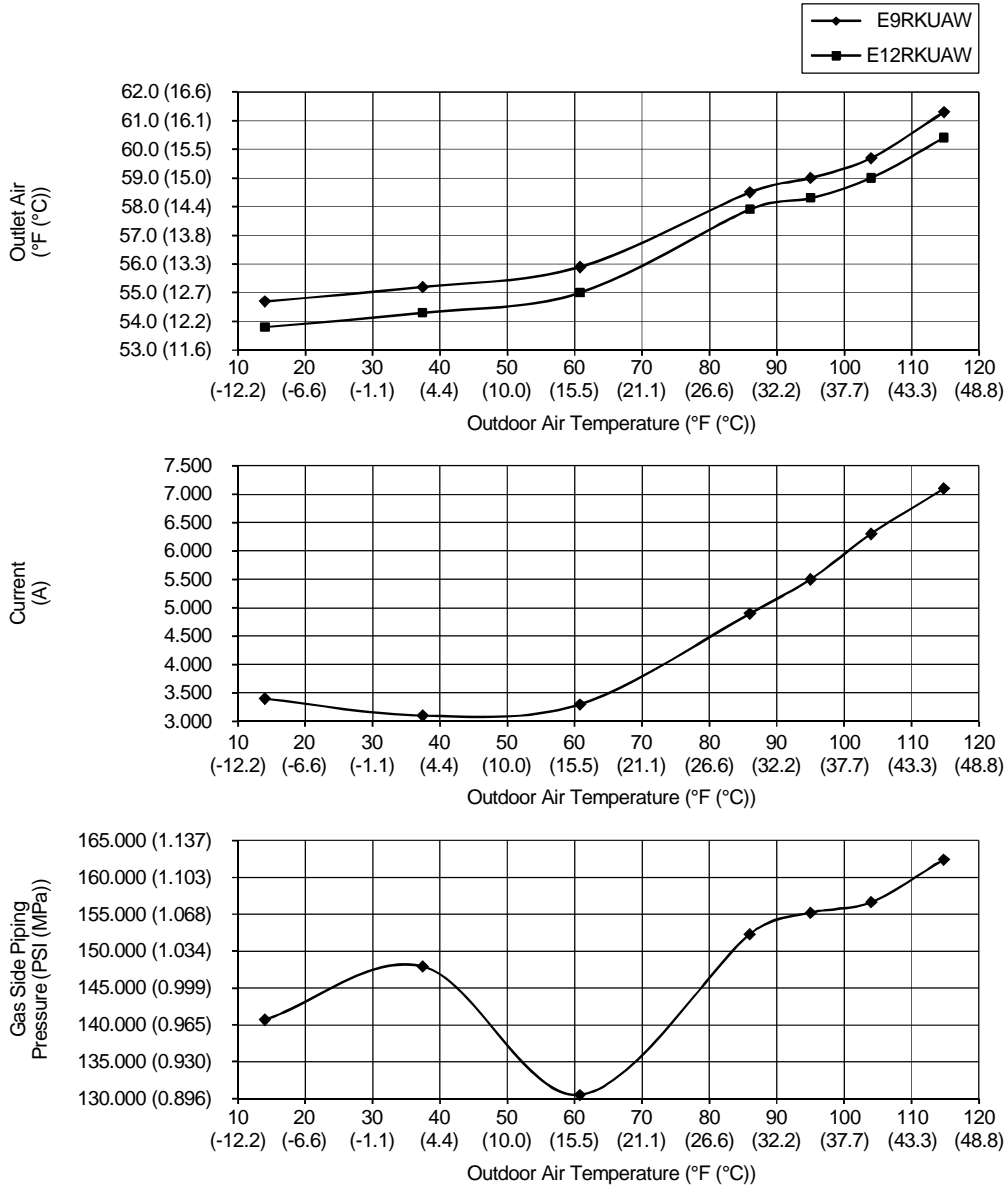

- Heating Characteristic

[Condition] Room temperature: 70.0°F (21.1°C) (DBT), 60.0°F (15.6°C) (WBT)

Operation condition: High fan speed

Piping Length: 7.5m (24.6 ft)

230V 60Hz

A) Indoor unit capacity: Heating (3.2 + 2.5: CS-E12RKUAW + CS-E9RKUAW), service mode frequency = 75Hz

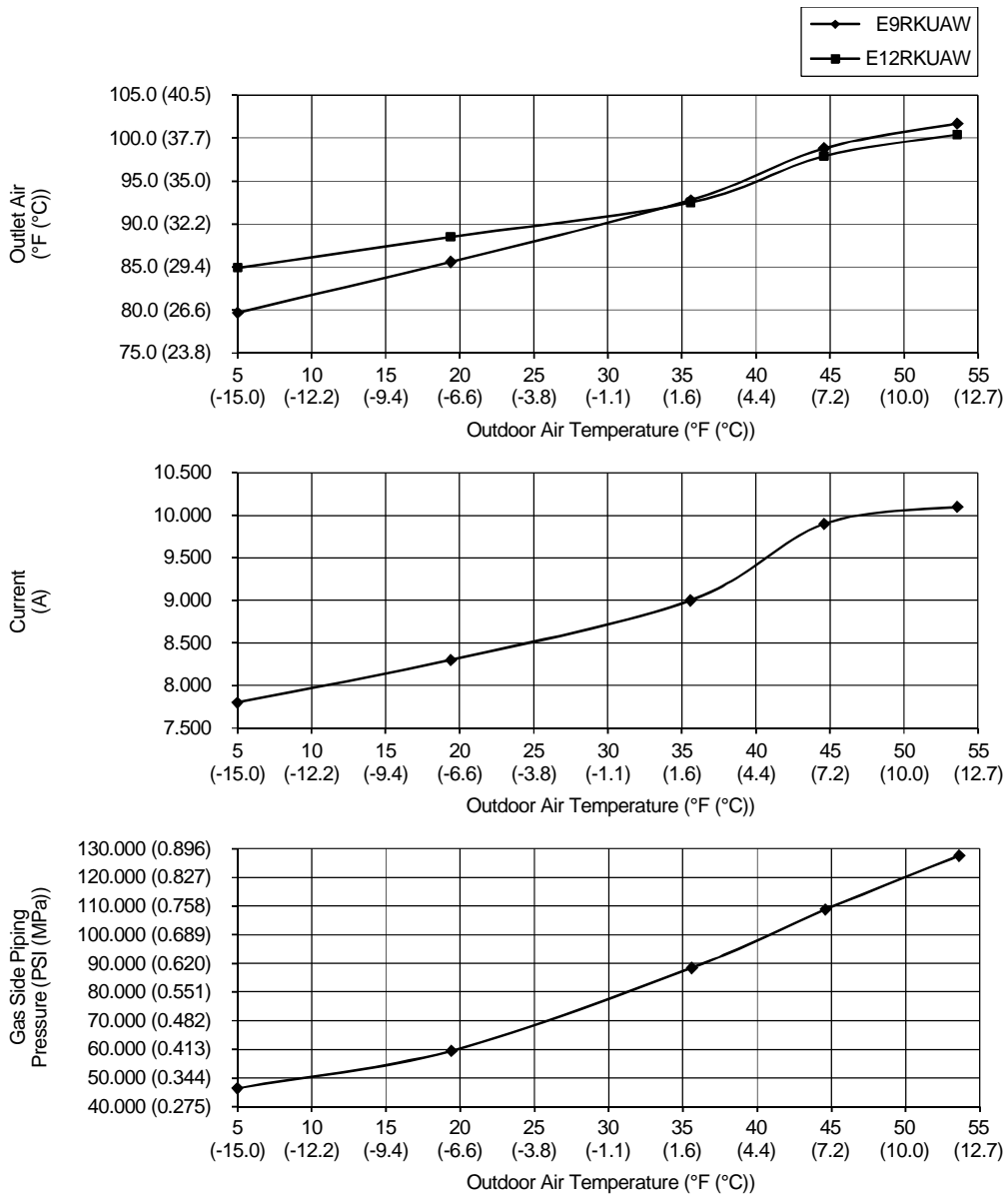

17.1.1.3 Three Indoor Unit Operation

- Cooling Characteristic

[Condition] Room temperature: 80.0°F (26.7°C) (DBT), 67.0°F (19.4°C) (WBT)

Operation condition: High fan speed

Piping Length: 7.5m (24.6 ft)

230V 60Hz

A) Indoor unit capacity: Cooling (3.2 + 2.5 + 2.0: CS-E12RKUAW + CS-E9RKUAW + CS-ME7RKUA), service mode frequency = 49Hz

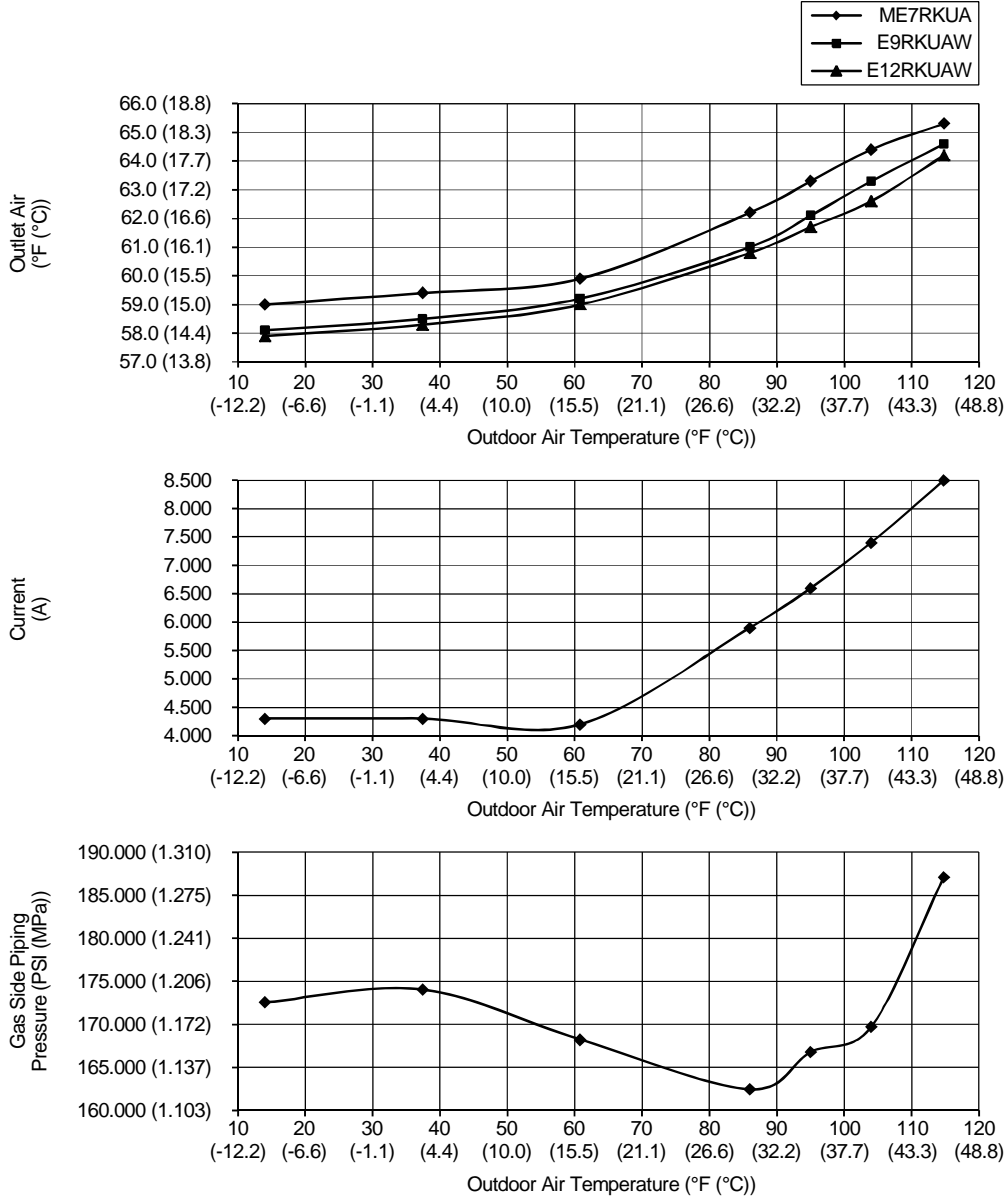

- Heating Characteristic

[Condition] Room temperature: 70.0°F (21.1°C) (DBT), 60.0°F (15.6°C) (WBT)

Operation condition: High fan speed

Piping Length: 7.5m (24.6 ft)

230V 60Hz

A) Indoor unit capacity: Heating (3.2 + 2.5 + 2.0: CS-E12RKUAW + CS-E9RKUAW + CS-ME7RKUA), service mode frequency = 75Hz

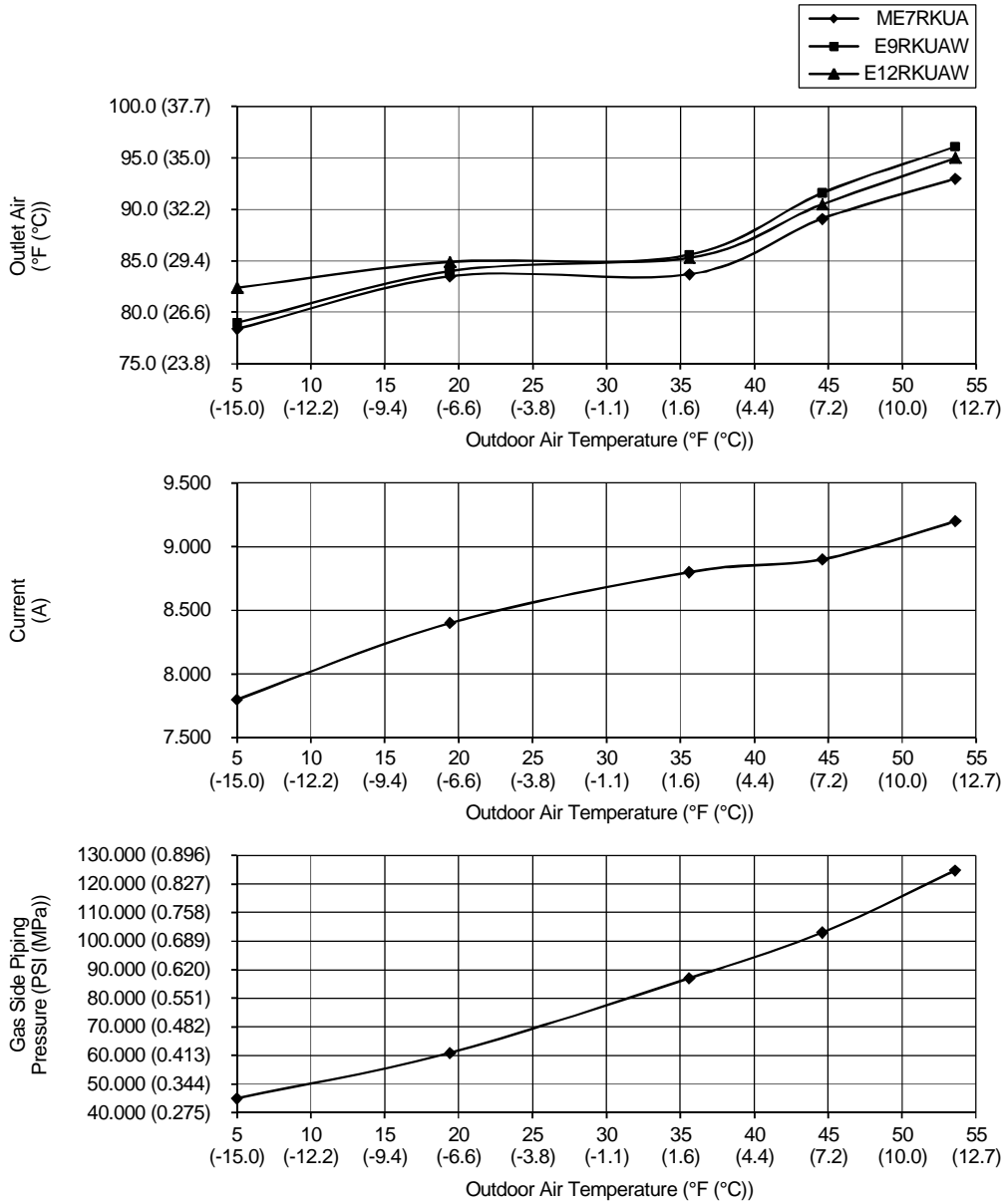

17.1.2 Capacity Table

17.1.2.1 Cooling

Cooling: 60Hz, 230V

Maximum capacity and Input power

Combination (Capacity)	Outdoor Air Temp. °F (°C) DB	Indoor Air Temp. °F (°C) WB											
		60.8 (16)		63.5 (17.5)		64.4 (18)		66.2 (19)		71.6 (22)		75.2 (24)	
		Total Capacity (BTU/h)	Input Power (kW)	Total Capacity (BTU/h)	Input Power (kW)	Total Capacity (BTU/h)	Input Power (kW)	Total Capacity (BTU/h)	Input Power (kW)	Total Capacity (BTU/h)	Input Power (kW)	Total Capacity (BTU/h)	Input Power (kW)
1.6 + 3.2	71.6 (22)	21940.04	1.53	22608.18	1.50	22830.89	1.50	23276.32	1.48	25616.30	1.46	27176.29	1.45
	77.0 (25)	21709.91	1.74	22460.47	1.74	22710.66	1.74	23211.03	1.74	25588.13	1.75	27172.85	1.76
	84.2 (29)	21177.18	1.99	21989.28	2.01	22259.98	2.02	22801.38	2.03	25155.43	2.06	26724.79	2.09
	89.6 (32)	20608.22	2.16	21430.20	2.18	21704.20	2.19	22252.19	2.21	24534.56	2.24	26056.14	2.27
	95.0 (35)	19894.04	2.31	20694.82	2.33	20961.75	2.34	21495.60	2.36	23659.67	2.38	25102.39	2.39
	104.0 (40)	18381.03	2.51	19077.40	2.53	19309.52	2.53	19773.76	2.54	21637.06	2.51	22879.26	2.49
	109.4 (43)	17279.61	2.61	17871.87	2.61	18069.29	2.60	18464.13	2.60	20084.81	2.52	21165.26	2.47
	114.8 (46)	16032.98	2.69	16490.05	2.66	16642.40	2.65	16947.12	2.63	18278.55	2.50	19166.17	2.41
1.6 + 5.0	71.6 (22)	23681.32	1.52	24402.48	1.50	24642.87	1.49	25123.65	1.47	27649.34	1.46	29333.14	1.45
	77.0 (25)	23432.92	1.73	24243.05	1.73	24513.09	1.73	25053.18	1.73	27618.93	1.74	29329.43	1.75
	84.2 (29)	22857.91	1.98	23734.46	2.00	24026.65	2.01	24611.01	2.02	27151.89	2.05	28845.81	2.08
	89.6 (32)	22243.79	2.15	23131.01	2.18	23426.75	2.18	24018.23	2.20	26481.74	2.23	28124.08	2.26
	95.0 (35)	21472.93	2.30	22337.26	2.32	22625.38	2.33	23201.60	2.35	25537.42	2.37	27094.64	2.38
	104.0 (40)	19839.85	2.50	20591.48	2.51	20842.02	2.52	21343.10	2.53	23354.29	2.50	24695.08	2.48
	109.4 (43)	18651.01	2.60	19290.28	2.60	19503.36	2.59	19929.54	2.59	21678.84	2.51	22845.04	2.46
	114.8 (46)	17305.44	2.68	17798.78	2.65	17963.23	2.64	18292.13	2.62	19729.22	2.49	20687.29	2.40
2.0 + 2.5	71.6 (22)	21591.79	1.53	22249.32	1.50	22468.50	1.50	22906.85	1.48	25209.69	1.46	26744.92	1.45
	77.0 (25)	21365.31	1.74	22103.96	1.74	22350.17	1.74	22842.60	1.74	25181.96	1.75	26741.54	1.76
	84.2 (29)	20841.04	1.99	21640.24	2.01	21906.65	2.02	22439.45	2.03	24756.14	2.06	26300.59	2.09
	89.6 (32)	20281.10	2.16	21090.04	2.18	21359.68	2.19	21898.98	2.21	24145.12	2.24	25642.55	2.27
	95.0 (35)	19578.26	2.31	20366.33	2.33	20629.02	2.34	21154.40	2.36	23284.12	2.38	24703.94	2.39
	104.0 (40)	18089.27	2.51	18774.58	2.53	19003.02	2.53	19459.89	2.54	21293.61	2.51	22516.10	2.49
	109.4 (43)	17005.34	2.61	17588.19	2.61	17782.48	2.60	18171.05	2.60	19766.00	2.52	20829.30	2.47
	114.8 (46)	15778.49	2.69	16228.30	2.66	16378.24	2.65	16678.11	2.63	17988.41	2.50	18861.94	2.41
2.0 + 3.2	71.6 (22)	21940.04	1.53	22608.18	1.50	22830.89	1.50	23276.32	1.48	25616.30	1.46	27176.29	1.45
	77.0 (25)	21709.91	1.74	22460.47	1.74	22710.66	1.74	23211.03	1.74	25588.13	1.75	27172.85	1.76
	84.2 (29)	21177.18	1.99	21989.28	2.01	22259.98	2.02	22801.38	2.03	25155.43	2.06	26724.79	2.09
	89.6 (32)	20608.22	2.16	21430.20	2.18	21704.20	2.19	22252.19	2.21	24534.56	2.24	26056.14	2.27
	95.0 (35)	19894.04	2.31	20694.82	2.33	20961.75	2.34	21495.60	2.36	23659.67	2.38	25102.39	2.39
	104.0 (40)	18381.03	2.51	19077.40	2.53	19309.52	2.53	19773.76	2.54	21637.06	2.51	22879.26	2.49
	109.4 (43)	17279.61	2.61	17871.87	2.61	18069.29	2.60	18464.13	2.60	20084.81	2.52	21165.26	2.47
	114.8 (46)	16032.98	2.69	16490.05	2.66	16642.40	2.65	16947.12	2.63	18278.55	2.50	19166.17	2.41

Combination (Capacity)	Outdoor Air Temp. °F (°C) DB	Indoor Air Temp. °F (°C) WB											
		60.8 (16)		63.5 (17.5)		64.4 (18)		66.2 (19)		71.6 (22)		75.2 (24)	
		Total Capacity (BTU/h)	Input Power (kW)	Total Capacity (BTU/h)	Input Power (kW)	Total Capacity (BTU/h)	Input Power (kW)	Total Capacity (BTU/h)	Input Power (kW)	Total Capacity (BTU/h)	Input Power (kW)	Total Capacity (BTU/h)	Input Power (kW)
2.0 + 5.0	71.6 (22)	23681.32	1.52	24402.48	1.50	24642.87	1.49	25123.65	1.47	27649.34	1.46	29333.14	1.45
	77.0 (25)	23432.92	1.73	24243.05	1.73	24513.09	1.73	25053.18	1.73	27618.93	1.74	29329.43	1.75
	84.2 (29)	22857.91	1.98	23734.46	2.00	24026.65	2.01	24611.01	2.02	27151.89	2.05	28845.81	2.08
	89.6 (32)	22243.79	2.15	23131.01	2.18	23426.75	2.18	24018.23	2.20	26481.74	2.23	28124.08	2.26
	95.0 (35)	21472.93	2.30	22337.26	2.32	22625.38	2.33	23201.60	2.35	25537.42	2.37	27094.64	2.38
	104.0 (40)	19839.85	2.50	20591.48	2.51	20842.02	2.52	21343.10	2.53	23354.29	2.50	24695.08	2.48
	109.4 (43)	18651.01	2.60	19290.28	2.60	19503.36	2.59	19929.54	2.59	21678.84	2.51	22845.04	2.46
	114.8 (46)	17305.44	2.68	17798.78	2.65	17963.23	2.64	18292.13	2.62	19729.22	2.49	20687.29	2.40
2.5 + 2.5	71.6 (22)	21591.79	1.53	22249.32	1.50	22468.50	1.50	22906.85	1.48	25209.69	1.46	26744.92	1.45
	77.0 (25)	21365.31	1.74	22103.96	1.74	22350.17	1.74	22842.60	1.74	25181.96	1.75	26741.54	1.76
	84.2 (29)	20841.04	1.99	21640.24	2.01	21906.65	2.02	22439.45	2.03	24756.14	2.06	26300.59	2.09
	89.6 (32)	20281.10	2.16	21090.04	2.18	21359.68	2.19	21898.98	2.21	24145.12	2.24	25642.55	2.27
	95.0 (35)	19578.26	2.31	20366.33	2.33	20629.02	2.34	21154.40	2.36	23284.12	2.38	24703.94	2.39
	104.0 (40)	18089.27	2.51	18774.58	2.53	19003.02	2.53	19459.89	2.54	21293.61	2.51	22516.10	2.49
	109.4 (43)	17005.34	2.61	17588.19	2.61	17782.48	2.60	18171.05	2.60	19766.00	2.52	20829.30	2.47
	114.8 (46)	15778.49	2.69	16228.30	2.66	16378.24	2.65	16678.11	2.63	17988.41	2.50	18861.94	2.41
2.5 + 3.2	71.6 (22)	21940.04	1.53	22608.18	1.50	22830.89	1.50	23276.32	1.48	25616.30	1.46	27176.29	1.45
	77.0 (25)	21709.91	1.74	22460.47	1.74	22710.66	1.74	23211.03	1.74	25588.13	1.75	27172.85	1.76
	84.2 (29)	21177.18	1.99	21989.28	2.01	22259.98	2.02	22801.38	2.03	25155.43	2.06	26724.79	2.09
	89.6 (32)	20608.22	2.16	21430.20	2.18	21704.20	2.19	22252.19	2.21	24534.56	2.24	26056.14	2.27
	95.0 (35)	19894.04	2.31	20694.82	2.33	20961.75	2.34	21495.60	2.36	23659.67	2.38	25102.39	2.39
	104.0 (40)	18381.03	2.51	19077.40	2.53	19309.52	2.53	19773.76	2.54	21637.06	2.51	22879.26	2.49
	109.4 (43)	17279.61	2.61	17871.87	2.61	18069.29	2.60	18464.13	2.60	20084.81	2.52	21165.26	2.47
	114.8 (46)	16032.98	2.69	16490.05	2.66	16642.40	2.65	16947.12	2.63	18278.55	2.50	19166.17	2.41
2.5 + 5.0	71.6 (22)	23681.32	1.52	24402.48	1.50	24642.87	1.49	25123.65	1.47	27649.34	1.46	29333.14	1.45
	77.0 (25)	23432.92	1.73	24243.05	1.73	24513.09	1.73	25053.18	1.73	27618.93	1.74	29329.43	1.75
	84.2 (29)	22857.91	1.98	23734.46	2.00	24026.65	2.01	24611.01	2.02	27151.89	2.05	28845.81	2.08
	89.6 (32)	22243.79	2.15	23131.01	2.18	23426.75	2.18	24018.23	2.20	26481.74	2.23	28124.08	2.26
	95.0 (35)	21472.93	2.30	22337.26	2.32	22625.38	2.33	23201.60	2.35	25537.42	2.37	27094.64	2.38
	104.0 (40)	19839.85	2.50	20591.48	2.51	20842.02	2.52	21343.10	2.53	23354.29	2.50	24695.08	2.48
	109.4 (43)	18651.01	2.60	19290.28	2.60	19503.36	2.59	19929.54	2.59	21678.84	2.51	22845.04	2.46
	114.8 (46)	17305.44	2.68	17798.78	2.65	17963.23	2.64	18292.13	2.62	19729.22	2.49	20687.29	2.40

Combination (Capacity)	Outdoor Air Temp. °F (°C) DB	Indoor Air Temp. °F (°C) WB											
		60.8 (16)		63.5 (17.5)		64.4 (18)		66.2 (19)		71.6 (22)		75.2 (24)	
		Total Capacity (BTU/h)	Input Power (kW)	Total Capacity (BTU/h)	Input Power (kW)	Total Capacity (BTU/h)	Input Power (kW)	Total Capacity (BTU/h)	Input Power (kW)	Total Capacity (BTU/h)	Input Power (kW)	Total Capacity (BTU/h)	Input Power (kW)
3.2 + 3.2	71.6 (22)	22288.30	1.53	22967.04	1.50	23193.29	1.50	23645.78	1.48	26022.91	1.46	27607.66	1.45
	77.0 (25)	22054.51	1.74	22816.99	1.74	23071.15	1.74	23579.46	1.74	25994.29	1.75	27604.17	1.76
	84.2 (29)	21513.33	1.99	22338.32	2.01	22613.31	2.02	23163.31	2.03	25554.72	2.06	27149.00	2.09
	89.6 (32)	20935.33	2.16	21770.36	2.18	22048.71	2.19	22605.39	2.21	24923.99	2.24	26469.73	2.27
	95.0 (35)	20209.81	2.31	21023.31	2.33	21294.47	2.34	21836.80	2.36	24035.22	2.38	25500.84	2.39
	104.0 (40)	18672.80	2.51	19380.21	2.53	19616.02	2.53	20087.63	2.54	21980.51	2.51	23242.42	2.49
	109.4 (43)	17553.89	2.61	18155.55	2.61	18356.11	2.60	18757.21	2.60	20403.62	2.52	21501.22	2.47
	114.8 (46)	16287.47	2.69	16751.79	2.66	16906.57	2.65	17216.12	2.63	18568.68	2.50	19470.39	2.41
3.2 + 5.0	71.6 (22)	24029.57	1.52	24761.34	1.50	25005.26	1.49	25493.11	1.47	28055.95	1.46	29764.51	1.45
	77.0 (25)	23777.52	1.73	24599.57	1.73	24873.58	1.73	25421.61	1.73	28025.09	1.74	29760.74	1.75
	84.2 (29)	23194.06	1.98	24083.50	2.00	24379.98	2.01	24972.94	2.02	27551.18	2.05	29270.01	2.08
	89.6 (32)	22570.90	2.15	23471.17	2.18	23771.26	2.18	24371.44	2.20	26871.18	2.23	28537.67	2.26
	95.0 (35)	21788.71	2.30	22665.75	2.32	22958.10	2.33	23542.80	2.35	25912.97	2.37	27493.09	2.38
	104.0 (40)	20131.61	2.50	20894.29	2.51	21148.52	2.52	21656.97	2.53	23697.73	2.50	25058.24	2.48
	109.4 (43)	18925.29	2.60	19573.96	2.60	19790.18	2.59	20222.62	2.59	21997.65	2.51	23181.00	2.46
	114.8 (46)	17559.93	2.68	18060.53	2.65	18227.39	2.64	18561.13	2.62	20019.36	2.49	20991.51	2.40
1.6 + 1.6 + 1.6	71.6 (22)	25422.59	1.61	26196.78	1.59	26454.84	1.58	26970.97	1.56	29682.38	1.55	31489.98	1.53
	77.0 (25)	25155.93	1.84	26025.63	1.83	26315.53	1.83	26895.32	1.83	29649.73	1.85	31486.00	1.86
	84.2 (29)	24538.64	2.10	25479.64	2.12	25793.31	2.13	26420.65	2.14	29148.35	2.18	30966.82	2.20
	89.6 (32)	23879.36	2.28	24831.82	2.31	25149.31	2.31	25784.28	2.33	28428.93	2.37	30192.03	2.39
	95.0 (35)	23051.82	2.43	23979.71	2.46	24289.01	2.47	24907.60	2.49	27415.18	2.51	29086.89	2.53
	104.0 (40)	21298.66	2.65	22105.55	2.66	22374.52	2.67	22912.45	2.68	25071.51	2.65	26510.89	2.63
	109.4 (43)	20022.41	2.76	20708.68	2.75	20937.43	2.75	21394.95	2.74	23272.87	2.66	24524.83	2.61
	114.8 (46)	18577.90	2.84	19107.52	2.81	19284.06	2.80	19637.13	2.78	21179.90	2.63	22208.41	2.54
1.6 + 1.6 + 2.0	71.6 (22)	25422.59	1.57	26196.78	1.54	26454.84	1.53	26970.97	1.52	29682.38	1.50	31489.98	1.49
	77.0 (25)	25155.93	1.78	26025.63	1.78	26315.53	1.78	26895.32	1.78	29649.73	1.80	31486.00	1.80
	84.2 (29)	24538.64	2.04	25479.64	2.06	25793.31	2.07	26420.65	2.08	29148.35	2.12	30966.82	2.14
	89.6 (32)	23879.36	2.21	24831.82	2.24	25149.31	2.25	25784.28	2.27	28428.93	2.30	30192.03	2.32
	95.0 (35)	23051.82	2.37	23979.71	2.39	24289.01	2.40	24907.60	2.42	27415.18	2.44	29086.89	2.46
	104.0 (40)	21298.66	2.58	22105.55	2.59	22374.52	2.59	22912.45	2.60	25071.51	2.57	26510.89	2.55
	109.4 (43)	20022.41	2.68	20708.68	2.67	20937.43	2.67	21394.95	2.67	23272.87	2.59	24524.83	2.54
	114.8 (46)	18577.90	2.76	19107.52	2.73	19284.06	2.72	19637.13	2.70	21179.90	2.56	22208.41	2.47

Combination (Capacity)	Outdoor Air Temp. °F (°C) DB	Indoor Air Temp. °F (°C) WB											
		60.8 (16)		63.5 (17.5)		64.4 (18)		66.2 (19)		71.6 (22)		75.2 (24)	
		Total Capacity (BTU/h)	Input Power (kW)	Total Capacity (BTU/h)	Input Power (kW)	Total Capacity (BTU/h)	Input Power (kW)	Total Capacity (BTU/h)	Input Power (kW)	Total Capacity (BTU/h)	Input Power (kW)	Total Capacity (BTU/h)	Input Power (kW)
1.6 + 1.6 + 2.5	71.6 (22)	25422.59	1.57	26196.78	1.54	26454.84	1.53	26970.97	1.52	29682.38	1.50	31489.98	1.49
	77.0 (25)	25155.93	1.78	26025.63	1.78	26315.53	1.78	26895.32	1.78	29649.73	1.80	31486.00	1.80
	84.2 (29)	24538.64	2.04	25479.64	2.06	25793.31	2.07	26420.65	2.08	29148.35	2.12	30966.82	2.14
	89.6 (32)	23879.36	2.21	24831.82	2.24	25149.31	2.25	25784.28	2.27	28428.93	2.30	30192.03	2.32
	95.0 (35)	23051.82	2.37	23979.71	2.39	24289.01	2.40	24907.60	2.42	27415.18	2.44	29086.89	2.46
	104.0 (40)	21298.66	2.58	22105.55	2.59	22374.52	2.59	22912.45	2.60	25071.51	2.57	26510.89	2.55
	109.4 (43)	20022.41	2.68	20708.68	2.67	20937.43	2.67	21394.95	2.67	23272.87	2.59	24524.83	2.54
	114.8 (46)	18577.90	2.76	19107.52	2.73	19284.06	2.72	19637.13	2.70	21179.90	2.56	22208.41	2.47
1.6 + 1.6 + 3.2	71.6 (22)	25422.59	1.56	26196.78	1.54	26454.84	1.53	26970.97	1.51	29682.38	1.50	31489.98	1.48
	77.0 (25)	25155.93	1.78	26025.63	1.78	26315.53	1.77	26895.32	1.77	29649.73	1.79	31486.00	1.80
	84.2 (29)	24538.64	2.03	25479.64	2.05	25793.31	2.06	26420.65	2.07	29148.35	2.11	30966.82	2.13
	89.6 (32)	23879.36	2.20	24831.82	2.23	25149.31	2.24	25784.28	2.26	28428.93	2.29	30192.03	2.31
	95.0 (35)	23051.82	2.36	23979.71	2.38	24289.01	2.39	24907.60	2.41	27415.18	2.43	29086.89	2.45
	104.0 (40)	21298.66	2.57	22105.55	2.58	22374.52	2.58	22912.45	2.59	25071.51	2.56	26510.89	2.54
	109.4 (43)	20022.41	2.67	20708.68	2.66	20937.43	2.66	21394.95	2.65	23272.87	2.58	24524.83	2.53
	114.8 (46)	18577.90	2.75	19107.52	2.72	19284.06	2.71	19637.13	2.69	21179.90	2.55	22208.41	2.46
1.6 + 1.6 + 5.0	71.6 (22)	25422.59	1.42	26196.78	1.40	26454.84	1.40	26970.97	1.38	29682.38	1.37	31489.98	1.36
	77.0 (25)	25155.93	1.62	26025.63	1.62	26315.53	1.62	26895.32	1.62	29649.73	1.63	31486.00	1.64
	84.2 (29)	24538.64	1.86	25479.64	1.87	25793.31	1.88	26420.65	1.89	29148.35	1.92	30966.82	1.94
	89.6 (32)	23879.36	2.01	24831.82	2.04	25149.31	2.04	25784.28	2.06	28428.93	2.09	30192.03	2.11
	95.0 (35)	23051.82	2.15	23979.71	2.18	24289.01	2.18	24907.60	2.20	27415.18	2.22	29086.89	2.23
	104.0 (40)	21298.66	2.34	22105.55	2.35	22374.52	2.36	22912.45	2.36	25071.51	2.34	26510.89	2.32
	109.4 (43)	20022.41	2.44	20708.68	2.43	20937.43	2.43	21394.95	2.42	23272.87	2.35	24524.83	2.31
	114.8 (46)	18577.90	2.51	19107.52	2.48	19284.06	2.47	19637.13	2.45	21179.90	2.33	22208.41	2.24
1.6 + 2.0 + 2.0	71.6 (22)	25422.59	1.57	26196.78	1.54	26454.84	1.53	26970.97	1.52	29682.38	1.50	31489.98	1.49
	77.0 (25)	25155.93	1.78	26025.63	1.78	26315.53	1.78	26895.32	1.78	29649.73	1.80	31486.00	1.80
	84.2 (29)	24538.64	2.04	25479.64	2.06	25793.31	2.07	26420.65	2.08	29148.35	2.12	30966.82	2.14
	89.6 (32)	23879.36	2.21	24831.82	2.24	25149.31	2.25	25784.28	2.27	28428.93	2.30	30192.03	2.32
	95.0 (35)	23051.82	2.37	23979.71	2.39	24289.01	2.40	24907.60	2.42	27415.18	2.44	29086.89	2.46
	104.0 (40)	21298.66	2.58	22105.55	2.59	22374.52	2.59	22912.45	2.60	25071.51	2.57	26510.89	2.55
	109.4 (43)	20022.41	2.68	20708.68	2.67	20937.43	2.67	21394.95	2.67	23272.87	2.59	24524.83	2.54
	114.8 (46)	18577.90	2.76	19107.52	2.73	19284.06	2.72	19637.13	2.70	21179.90	2.56	22208.41	2.47

Combination (Capacity)	Outdoor Air Temp. °F (°C) DB	Indoor Air Temp. °F (°C) WB											
		60.8 (16)		63.5 (17.5)		64.4 (18)		66.2 (19)		71.6 (22)		75.2 (24)	
		Total Capacity (BTU/h)	Input Power (kW)	Total Capacity (BTU/h)	Input Power (kW)	Total Capacity (BTU/h)	Input Power (kW)	Total Capacity (BTU/h)	Input Power (kW)	Total Capacity (BTU/h)	Input Power (kW)	Total Capacity (BTU/h)	Input Power (kW)
1.6 + 2.0 + 2.5	71.6 (22)	25422.59	1.57	26196.78	1.54	26454.84	1.53	26970.97	1.52	29682.38	1.50	31489.98	1.49
	77.0 (25)	25155.93	1.78	26025.63	1.78	26315.53	1.78	26895.32	1.78	29649.73	1.80	31486.00	1.80
	84.2 (29)	24538.64	2.04	25479.64	2.06	25793.31	2.07	26420.65	2.08	29148.35	2.12	30966.82	2.14
	89.6 (32)	23879.36	2.21	24831.82	2.24	25149.31	2.25	25784.28	2.27	28428.93	2.30	30192.03	2.32
	95.0 (35)	23051.82	2.37	23979.71	2.39	24289.01	2.40	24907.60	2.42	27415.18	2.44	29086.89	2.46
	104.0 (40)	21298.66	2.58	22105.55	2.59	22374.52	2.59	22912.45	2.60	25071.51	2.57	26510.89	2.55
	109.4 (43)	20022.41	2.68	20708.68	2.67	20937.43	2.67	21394.95	2.67	23272.87	2.59	24524.83	2.54
	114.8 (46)	18577.90	2.76	19107.52	2.73	19284.06	2.72	19637.13	2.70	21179.90	2.56	22208.41	2.47
1.6 + 2.0 + 3.2	71.6 (22)	25422.59	1.52	26196.78	1.49	26454.84	1.48	26970.97	1.47	29682.38	1.45	31489.98	1.44
	77.0 (25)	25155.93	1.72	26025.63	1.72	26315.53	1.72	26895.32	1.72	29649.73	1.74	31486.00	1.75
	84.2 (29)	24538.64	1.97	25479.64	1.99	25793.31	2.00	26420.65	2.01	29148.35	2.05	30966.82	2.07
	89.6 (32)	23879.36	2.14	24831.82	2.17	25149.31	2.18	25784.28	2.19	28428.93	2.23	30192.03	2.25
	95.0 (35)	23051.82	2.29	23979.71	2.31	24289.01	2.32	24907.60	2.34	27415.18	2.36	29086.89	2.37
	104.0 (40)	21298.66	2.49	22105.55	2.50	22374.52	2.51	22912.45	2.52	25071.51	2.49	26510.89	2.47
	109.4 (43)	20022.41	2.59	20708.68	2.58	20937.43	2.58	21394.95	2.58	23272.87	2.50	24524.83	2.45
	114.8 (46)	18577.90	2.67	19107.52	2.64	19284.06	2.63	19637.13	2.61	21179.90	2.47	22208.41	2.39
1.6 + 2.0 + 5.0	71.6 (22)	25422.59	1.42	26196.78	1.40	26454.84	1.40	26970.97	1.38	29682.38	1.37	31489.98	1.36
	77.0 (25)	25155.93	1.62	26025.63	1.62	26315.53	1.62	26895.32	1.62	29649.73	1.63	31486.00	1.64
	84.2 (29)	24538.64	1.86	25479.64	1.87	25793.31	1.88	26420.65	1.89	29148.35	1.92	30966.82	1.94
	89.6 (32)	23879.36	2.01	24831.82	2.04	25149.31	2.04	25784.28	2.06	28428.93	2.09	30192.03	2.11
	95.0 (35)	23051.82	2.15	23979.71	2.18	24289.01	2.18	24907.60	2.20	27415.18	2.22	29086.89	2.23
	104.0 (40)	21298.66	2.34	22105.55	2.35	22374.52	2.36	22912.45	2.36	25071.51	2.34	26510.89	2.32
	109.4 (43)	20022.41	2.44	20708.68	2.43	20937.43	2.43	21394.95	2.42	23272.87	2.35	24524.83	2.31
	114.8 (46)	18577.90	2.51	19107.52	2.48	19284.06	2.47	19637.13	2.45	21179.90	2.33	22208.41	2.24
1.6 + 2.5 + 2.5	71.6 (22)	25422.59	1.57	26196.78	1.54	26454.84	1.53	26970.97	1.52	29682.38	1.50	31489.98	1.49
	77.0 (25)	25155.93	1.78	26025.63	1.78	26315.53	1.78	26895.32	1.78	29649.73	1.80	31486.00	1.80
	84.2 (29)	24538.64	2.04	25479.64	2.06	25793.31	2.07	26420.65	2.08	29148.35	2.12	30966.82	2.14
	89.6 (32)	23879.36	2.21	24831.82	2.24	25149.31	2.25	25784.28	2.27	28428.93	2.30	30192.03	2.32
	95.0 (35)	23051.82	2.37	23979.71	2.39	24289.01	2.40	24907.60	2.42	27415.18	2.44	29086.89	2.46
	104.0 (40)	21298.66	2.58	22105.55	2.59	22374.52	2.59	22912.45	2.60	25071.51	2.57	26510.89	2.55
	109.4 (43)	20022.41	2.68	20708.68	2.67	20937.43	2.67	21394.95	2.67	23272.87	2.59	24524.83	2.54
	114.8 (46)	18577.90	2.76	19107.52	2.73	19284.06	2.72	19637.13	2.70	21179.90	2.56	22208.41	2.47

Combination (Capacity)	Outdoor Air Temp. °F (°C) DB	Indoor Air Temp. °F (°C) WB											
		60.8 (16)		63.5 (17.5)		64.4 (18)		66.2 (19)		71.6 (22)		75.2 (24)	
		Total Capacity (BTU/h)	Input Power (kW)	Total Capacity (BTU/h)	Input Power (kW)	Total Capacity (BTU/h)	Input Power (kW)	Total Capacity (BTU/h)	Input Power (kW)	Total Capacity (BTU/h)	Input Power (kW)	Total Capacity (BTU/h)	Input Power (kW)
1.6 + 2.5 + 3.2	71.6 (22)	25422.59	1.52	26196.78	1.49	26454.84	1.48	26970.97	1.47	29682.38	1.45	31489.98	1.44
	77.0 (25)	25155.93	1.72	26025.63	1.72	26315.53	1.72	26895.32	1.72	29649.73	1.74	31486.00	1.75
	84.2 (29)	24538.64	1.97	25479.64	1.99	25793.31	2.00	26420.65	2.01	29148.35	2.05	30966.82	2.07
	89.6 (32)	23879.36	2.14	24831.82	2.17	25149.31	2.18	25784.28	2.19	28428.93	2.23	30192.03	2.25
	95.0 (35)	23051.82	2.29	23979.71	2.31	24289.01	2.32	24907.60	2.34	27415.18	2.36	29086.89	2.37
	104.0 (40)	21298.66	2.49	22105.55	2.50	22374.52	2.51	22912.45	2.52	25071.51	2.49	26510.89	2.47
	109.4 (43)	20022.41	2.59	20708.68	2.58	20937.43	2.58	21394.95	2.58	23272.87	2.50	24524.83	2.45
	114.8 (46)	18577.90	2.67	19107.52	2.64	19284.06	2.63	19637.13	2.61	21179.90	2.47	22208.41	2.39
1.6 + 3.2 + 3.2	71.6 (22)	25422.59	1.52	26196.78	1.49	26454.84	1.48	26970.97	1.47	29682.38	1.45	31489.98	1.44
	77.0 (25)	25155.93	1.72	26025.63	1.72	26315.53	1.72	26895.32	1.72	29649.73	1.74	31486.00	1.75
	84.2 (29)	24538.64	1.97	25479.64	1.99	25793.31	2.00	26420.65	2.01	29148.35	2.05	30966.82	2.07
	89.6 (32)	23879.36	2.14	24831.82	2.17	25149.31	2.18	25784.28	2.19	28428.93	2.23	30192.03	2.25
	95.0 (35)	23051.82	2.29	23979.71	2.31	24289.01	2.32	24907.60	2.34	27415.18	2.36	29086.89	2.37
	104.0 (40)	21298.66	2.49	22105.55	2.50	22374.52	2.51	22912.45	2.52	25071.51	2.49	26510.89	2.47
	109.4 (43)	20022.41	2.59	20708.68	2.58	20937.43	2.58	21394.95	2.58	23272.87	2.50	24524.83	2.45
	114.8 (46)	18577.90	2.67	19107.52	2.64	19284.06	2.63	19637.13	2.61	21179.90	2.47	22208.41	2.39
2.0 + 2.0 + 2.0	71.6 (22)	25422.59	1.57	26196.78	1.54	26454.84	1.53	26970.97	1.52	29682.38	1.50	31489.98	1.49
	77.0 (25)	25155.93	1.78	26025.63	1.78	26315.53	1.78	26895.32	1.78	29649.73	1.80	31486.00	1.80
	84.2 (29)	24538.64	2.04	25479.64	2.06	25793.31	2.07	26420.65	2.08	29148.35	2.12	30966.82	2.14
	89.6 (32)	23879.36	2.21	24831.82	2.24	25149.31	2.25	25784.28	2.27	28428.93	2.30	30192.03	2.32
	95.0 (35)	23051.82	2.37	23979.71	2.39	24289.01	2.40	24907.60	2.42	27415.18	2.44	29086.89	2.46
	104.0 (40)	21298.66	2.58	22105.55	2.59	22374.52	2.59	22912.45	2.60	25071.51	2.57	26510.89	2.55
	109.4 (43)	20022.41	2.68	20708.68	2.67	20937.43	2.67	21394.95	2.67	23272.87	2.59	24524.83	2.54
	114.8 (46)	18577.90	2.76	19107.52	2.73	19284.06	2.72	19637.13	2.70	21179.90	2.56	22208.41	2.47
2.0 + 2.0 + 2.5	71.6 (22)	25422.59	1.57	26196.78	1.54	26454.84	1.53	26970.97	1.52	29682.38	1.50	31489.98	1.49
	77.0 (25)	25155.93	1.78	26025.63	1.78	26315.53	1.78	26895.32	1.78	29649.73	1.80	31486.00	1.80
	84.2 (29)	24538.64	2.04	25479.64	2.06	25793.31	2.07	26420.65	2.08	29148.35	2.12	30966.82	2.14
	89.6 (32)	23879.36	2.21	24831.82	2.24	25149.31	2.25	25784.28	2.27	28428.93	2.30	30192.03	2.32
	95.0 (35)	23051.82	2.37	23979.71	2.39	24289.01	2.40	24907.60	2.42	27415.18	2.44	29086.89	2.46
	104.0 (40)	21298.66	2.58	22105.55	2.59	22374.52	2.59	22912.45	2.60	25071.51	2.57	26510.89	2.55
	109.4 (43)	20022.41	2.68	20708.68	2.67	20937.43	2.67	21394.95	2.67	23272.87	2.59	24524.83	2.54
	114.8 (46)	18577.90	2.76	19107.52	2.73	19284.06	2.72	19637.13	2.70	21179.90	2.56	22208.41	2.47

Combination (Capacity)	Outdoor Air Temp. °F (°C) DB	Indoor Air Temp. °F (°C) WB											
		60.8 (16)		63.5 (17.5)		64.4 (18)		66.2 (19)		71.6 (22)		75.2 (24)	
		Total Capacity (BTU/h)	Input Power (kW)	Total Capacity (BTU/h)	Input Power (kW)	Total Capacity (BTU/h)	Input Power (kW)	Total Capacity (BTU/h)	Input Power (kW)	Total Capacity (BTU/h)	Input Power (kW)	Total Capacity (BTU/h)	Input Power (kW)
2.0 + 2.0 + 3.2	71.6 (22)	25422.59	1.52	26196.78	1.49	26454.84	1.48	26970.97	1.47	29682.38	1.45	31489.98	1.44
	77.0 (25)	25155.93	1.72	26025.63	1.72	26315.53	1.72	26895.32	1.72	29649.73	1.74	31486.00	1.75
	84.2 (29)	24538.64	1.97	25479.64	1.99	25793.31	2.00	26420.65	2.01	29148.35	2.05	30966.82	2.07
	89.6 (32)	23879.36	2.14	24831.82	2.17	25149.31	2.18	25784.28	2.19	28428.93	2.23	30192.03	2.25
	95.0 (35)	23051.82	2.29	23979.71	2.31	24289.01	2.32	24907.60	2.34	27415.18	2.36	29086.89	2.37
	104.0 (40)	21298.66	2.49	22105.55	2.50	22374.52	2.51	22912.45	2.52	25071.51	2.49	26510.89	2.47
	109.4 (43)	20022.41	2.59	20708.68	2.58	20937.43	2.58	21394.95	2.58	23272.87	2.50	24524.83	2.45
	114.8 (46)	18577.90	2.67	19107.52	2.64	19284.06	2.63	19637.13	2.61	21179.90	2.47	22208.41	2.39
2.0 + 2.0 + 5.0	71.6 (22)	25422.59	1.38	26196.78	1.36	26454.84	1.35	26970.97	1.34	29682.38	1.32	31489.98	1.31
	77.0 (25)	25155.93	1.57	26025.63	1.57	26315.53	1.57	26895.32	1.57	29649.73	1.58	31486.00	1.59
	84.2 (29)	24538.64	1.80	25479.64	1.81	25793.31	1.82	26420.65	1.83	29148.35	1.86	30966.82	1.88
	89.6 (32)	23879.36	1.95	24831.82	1.97	25149.31	1.98	25784.28	2.00	28428.93	2.03	30192.03	2.05
	95.0 (35)	23051.82	2.08	23979.71	2.11	24289.01	2.11	24907.60	2.13	27415.18	2.15	29086.89	2.16
	104.0 (40)	21298.66	2.27	22105.55	2.28	22374.52	2.28	22912.45	2.29	25071.51	2.26	26510.89	2.25
	109.4 (43)	20022.41	2.36	20708.68	2.35	20937.43	2.35	21394.95	2.35	23272.87	2.28	24524.83	2.23
	114.8 (46)	18577.90	2.43	19107.52	2.40	19284.06	2.39	19637.13	2.37	21179.90	2.25	22208.41	2.17
2.0 + 2.5 + 2.5	71.6 (22)	25422.59	1.57	26196.78	1.54	26454.84	1.53	26970.97	1.52	29682.38	1.50	31489.98	1.49
	77.0 (25)	25155.93	1.78	26025.63	1.78	26315.53	1.78	26895.32	1.78	29649.73	1.80	31486.00	1.80
	84.2 (29)	24538.64	2.04	25479.64	2.06	25793.31	2.07	26420.65	2.08	29148.35	2.12	30966.82	2.14
	89.6 (32)	23879.36	2.21	24831.82	2.24	25149.31	2.25	25784.28	2.27	28428.93	2.30	30192.03	2.32
	95.0 (35)	23051.82	2.37	23979.71	2.39	24289.01	2.40	24907.60	2.42	27415.18	2.44	29086.89	2.46
	104.0 (40)	21298.66	2.58	22105.55	2.59	22374.52	2.59	22912.45	2.60	25071.51	2.57	26510.89	2.55
	109.4 (43)	20022.41	2.68	20708.68	2.67	20937.43	2.67	21394.95	2.67	23272.87	2.59	24524.83	2.54
	114.8 (46)	18577.90	2.76	19107.52	2.73	19284.06	2.72	19637.13	2.70	21179.90	2.56	22208.41	2.47
2.0 + 2.5 + 3.2	71.6 (22)	25422.59	1.52	26196.78	1.49	26454.84	1.48	26970.97	1.47	29682.38	1.45	31489.98	1.44
	77.0 (25)	25155.93	1.72	26025.63	1.72	26315.53	1.72	26895.32	1.72	29649.73	1.74	31486.00	1.75
	84.2 (29)	24538.64	1.97	25479.64	1.99	25793.31	2.00	26420.65	2.01	29148.35	2.05	30966.82	2.07
	89.6 (32)	23879.36	2.14	24831.82	2.17	25149.31	2.18	25784.28	2.19	28428.93	2.23	30192.03	2.25
	95.0 (35)	23051.82	2.29	23979.71	2.31	24289.01	2.32	24907.60	2.34	27415.18	2.36	29086.89	2.37
	104.0 (40)	21298.66	2.49	22105.55	2.50	22374.52	2.51	22912.45	2.52	25071.51	2.49	26510.89	2.47
	109.4 (43)	20022.41	2.59	20708.68	2.58	20937.43	2.58	21394.95	2.58	23272.87	2.50	24524.83	2.45
	114.8 (46)	18577.90	2.67	19107.52	2.64	19284.06	2.63	19637.13	2.61	21179.90	2.47	22208.41	2.39

Combination (Capacity)	Outdoor Air Temp. °F (°C) DB	Indoor Air Temp. °F (°C) WB											
		60.8 (16)		63.5 (17.5)		64.4 (18)		66.2 (19)		71.6 (22)		75.2 (24)	
		Total Capacity (BTU/h)	Input Power (kW)	Total Capacity (BTU/h)	Input Power (kW)	Total Capacity (BTU/h)	Input Power (kW)	Total Capacity (BTU/h)	Input Power (kW)	Total Capacity (BTU/h)	Input Power (kW)	Total Capacity (BTU/h)	Input Power (kW)
2.0 + 3.2 + 3.2	71.6 (22)	25422.59	1.47	26196.78	1.45	26454.84	1.44	26970.97	1.42	29682.38	1.41	31489.98	1.40
	77.0 (25)	25155.93	1.67	26025.63	1.67	26315.53	1.67	26895.32	1.67	29649.73	1.68	31486.00	1.69
	84.2 (29)	24538.64	1.92	25479.64	1.93	25793.31	1.94	26420.65	1.95	29148.35	1.98	30966.82	2.01
	89.6 (32)	23879.36	2.08	24831.82	2.10	25149.31	2.11	25784.28	2.13	28428.93	2.16	30192.03	2.18
	95.0 (35)	23051.82	2.22	23979.71	2.24	24289.01	2.25	24907.60	2.27	27415.18	2.29	29086.89	2.30
	104.0 (40)	21298.66	2.42	22105.55	2.43	22374.52	2.43	22912.45	2.44	25071.51	2.41	26510.89	2.39
	109.4 (43)	20022.41	2.51	20708.68	2.51	20937.43	2.50	21394.95	2.50	23272.87	2.43	24524.83	2.38
	114.8 (46)	18577.90	2.59	19107.52	2.56	19284.06	2.55	19637.13	2.53	21179.90	2.40	22208.41	2.31
2.5 + 2.5 + 2.5	71.6 (22)	25422.59	1.57	26196.78	1.54	26454.84	1.53	26970.97	1.52	29682.38	1.50	31489.98	1.49
	77.0 (25)	25155.93	1.78	26025.63	1.78	26315.53	1.78	26895.32	1.78	29649.73	1.80	31486.00	1.80
	84.2 (29)	24538.64	2.04	25479.64	2.06	25793.31	2.07	26420.65	2.08	29148.35	2.12	30966.82	2.14
	89.6 (32)	23879.36	2.21	24831.82	2.24	25149.31	2.25	25784.28	2.27	28428.93	2.30	30192.03	2.32
	95.0 (35)	23051.82	2.37	23979.71	2.39	24289.01	2.40	24907.60	2.42	27415.18	2.44	29086.89	2.46
	104.0 (40)	21298.66	2.58	22105.55	2.59	22374.52	2.59	22912.45	2.60	25071.51	2.57	26510.89	2.55
	109.4 (43)	20022.41	2.68	20708.68	2.67	20937.43	2.67	21394.95	2.67	23272.87	2.59	24524.83	2.54
	114.8 (46)	18577.90	2.76	19107.52	2.73	19284.06	2.72	19637.13	2.70	21179.90	2.56	22208.41	2.47
2.5 + 2.5 + 3.2	71.6 (22)	25422.59	1.52	26196.78	1.49	26454.84	1.48	26970.97	1.47	29682.38	1.45	31489.98	1.44
	77.0 (25)	25155.93	1.72	26025.63	1.72	26315.53	1.72	26895.32	1.72	29649.73	1.74	31486.00	1.75
	84.2 (29)	24538.64	1.97	25479.64	1.99	25793.31	2.00	26420.65	2.01	29148.35	2.05	30966.82	2.07
	89.6 (32)	23879.36	2.14	24831.82	2.17	25149.31	2.18	25784.28	2.19	28428.93	2.23	30192.03	2.25
	95.0 (35)	23051.82	2.29	23979.71	2.31	24289.01	2.32	24907.60	2.34	27415.18	2.36	29086.89	2.37
	104.0 (40)	21298.66	2.49	22105.55	2.50	22374.52	2.51	22912.45	2.52	25071.51	2.49	26510.89	2.47
	109.4 (43)	20022.41	2.59	20708.68	2.58	20937.43	2.58	21394.95	2.58	23272.87	2.50	24524.83	2.45
	114.8 (46)	18577.90	2.67	19107.52	2.64	19284.06	2.63	19637.13	2.61	21179.90	2.47	22208.41	2.39
2.5 + 3.2 + 3.2	71.6 (22)	25422.59	1.47	26196.78	1.45	26454.84	1.44	26970.97	1.42	29682.38	1.41	31489.98	1.40
	77.0 (25)	25155.93	1.67	26025.63	1.67	26315.53	1.67	26895.32	1.67	29649.73	1.68	31486.00	1.69
	84.2 (29)	24538.64	1.92	25479.64	1.93	25793.31	1.94	26420.65	1.95	29148.35	1.98	30966.82	2.01
	89.6 (32)	23879.36	2.08	24831.82	2.10	25149.31	2.11	25784.28	2.13	28428.93	2.16	30192.03	2.18
	95.0 (35)	23051.82	2.22	23979.71	2.24	24289.01	2.25	24907.60	2.27	27415.18	2.29	29086.89	2.30
	104.0 (40)	21298.66	2.42	22105.55	2.43	22374.52	2.43	22912.45	2.44	25071.51	2.41	26510.89	2.39
	109.4 (43)	20022.41	2.51	20708.68	2.51	20937.43	2.50	21394.95	2.50	23272.87	2.43	24524.83	2.38
	114.8 (46)	18577.90	2.59	19107.52	2.56	19284.06	2.55	19637.13	2.53	21179.90	2.40	22208.41	2.31

17.1.2.2 Heating

Heating: 60Hz, 230V

Maximum capacity and Input power

Combination (Capacity)	Indoor Air Temp. °F (°C) DB	Outdoor Air Temp. °F (°C) WB													
		59.0 (15)		50.0 (10)		42.8 (6)		32.0 (0)		23.0 (-5)		14.0 (-10)		5.0 (-15)	
		Total Capacity (BTU/h)	Input Power (kW)	Total Capacity (BTU/h)	Input Power (kW)	Total Capacity (BTU/h)	Input Power (kW)	Total Capacity (BTU/h)	Input Power (kW)	Total Capacity (BTU/h)	Input Power (kW)	Total Capacity (BTU/h)	Input Power (kW)	Total Capacity (BTU/h)	Input Power (kW)
1.6 + 3.2	60.8 (16)	49045.39	1.65	34336.77	2.03	27242.61	2.26	22611.82	2.45	20748.39	2.56	20032.93	2.54	18041.89	2.43
	64.4 (18)	48683.59	1.71	33494.11	2.06	26075.10	2.27	21178.66	2.47	19305.47	2.59	18931.04	2.60	17681.74	2.53
	68.0 (20)	48321.79	1.78	32651.45	2.09	24907.60	2.29	19745.50	2.48	17862.56	2.62	17829.15	2.66	17321.60	2.63
	69.8 (21)	47787.91	1.82	31933.73	2.11	24433.28	2.31	19829.76	2.49	18622.77	2.62	18830.88	2.66	17975.46	2.64
	71.6 (22)	47254.03	1.86	31216.00	2.14	23958.95	2.32	19914.01	2.50	19382.99	2.63	19832.60	2.66	18629.33	2.64
	75.2 (24)	46186.26	1.93	29780.56	2.19	23010.30	2.36	20082.51	2.52	20903.43	2.63	21836.06	2.67	19937.05	2.65
1.6 + 5.0	60.8 (16)	53748.37	1.70	37629.33	2.08	29854.91	2.31	24780.08	2.52	22737.96	2.63	21953.90	2.61	19771.93	2.49
	64.4 (18)	53351.88	1.76	36705.87	2.11	28575.46	2.33	23209.49	2.53	21156.68	2.66	20746.34	2.67	19377.25	2.60
	68.0 (20)	52955.39	1.82	35782.41	2.14	27296.00	2.35	21638.91	2.55	19575.40	2.69	19538.79	2.73	18982.58	2.70
	69.8 (21)	52370.31	1.86	34995.87	2.17	26776.19	2.37	21731.24	2.55	20408.52	2.69	20636.58	2.73	19699.14	2.71
	71.6 (22)	51785.24	1.90	34209.32	2.20	26256.38	2.38	21823.57	2.56	21241.63	2.69	21734.36	2.73	20415.70	2.71
	75.2 (24)	50615.08	1.98	32636.23	2.25	25216.77	2.42	22008.23	2.58	22907.87	2.70	23929.93	2.74	21848.82	2.72
2.0 + 2.5	60.8 (16)	47029.83	1.59	32925.67	1.96	26123.05	2.18	21682.57	2.37	19895.72	2.47	19209.66	2.45	17300.44	2.34
	64.4 (18)	46682.89	1.65	32117.64	1.99	25003.53	2.19	20308.31	2.38	18512.10	2.50	18153.05	2.51	16955.10	2.44
	68.0 (20)	46335.96	1.71	31309.61	2.02	23884.00	2.21	18934.04	2.39	17128.48	2.53	17096.44	2.57	16609.76	2.54
	69.8 (21)	45824.02	1.75	30621.38	2.04	23429.17	2.23	19014.83	2.40	17857.45	2.53	18057.00	2.57	17236.75	2.54
	71.6 (22)	45312.08	1.79	29933.16	2.07	22974.34	2.24	19095.62	2.41	18586.43	2.53	19017.57	2.57	17863.74	2.55
	75.2 (24)	44288.20	1.87	28556.70	2.12	22064.67	2.28	19257.20	2.43	20044.38	2.54	20938.69	2.57	19117.72	2.56
2.0 + 3.2	60.8 (16)	49045.39	1.64	34336.77	2.02	27242.61	2.25	22611.82	2.44	20748.39	2.55	20032.93	2.53	18041.89	2.42
	64.4 (18)	48683.59	1.71	33494.11	2.05	26075.10	2.26	21178.66	2.46	19305.47	2.58	18931.04	2.59	17681.74	2.52
	68.0 (20)	48321.79	1.77	32651.45	2.08	24907.60	2.28	19745.50	2.47	17862.56	2.61	17829.15	2.65	17321.60	2.62
	69.8 (21)	47787.91	1.81	31933.73	2.11	24433.28	2.30	19829.76	2.48	18622.77	2.61	18830.88	2.65	17975.46	2.62
	71.6 (22)	47254.03	1.85	31216.00	2.13	23958.95	2.31	19914.01	2.49	19382.99	2.61	19832.60	2.65	18629.33	2.63
	75.2 (24)	46186.26	1.93	29780.56	2.18	23010.30	2.35	20082.51	2.50	20903.43	2.62	21836.06	2.66	19937.05	2.64
2.0 + 5.0	60.8 (16)	53748.37	1.69	37629.33	2.07	29854.91	2.30	24780.08	2.51	22737.96	2.62	21953.90	2.60	19771.93	2.48
	64.4 (18)	53351.88	1.75	36705.87	2.10	28575.46	2.32	23209.49	2.52	21156.68	2.65	20746.34	2.66	19377.25	2.58
	68.0 (20)	52955.39	1.82	35782.41	2.13	27296.00	2.34	21638.91	2.53	19575.40	2.68	19538.79	2.72	18982.58	2.69
	69.8 (21)	52370.31	1.86	34995.87	2.16	26776.19	2.36	21731.24	2.54	20408.52	2.68	20636.58	2.72	19699.14	2.69
	71.6 (22)	51785.24	1.90	34209.32	2.19	26256.38	2.37	21823.57	2.55	21241.63	2.68	21734.36	2.72	20415.70	2.70
	75.2 (24)	50615.08	1.98	32636.23	2.24	25216.77	2.41	22008.23	2.57	22907.87	2.69	23929.93	2.73	21848.82	2.71

Combination (Capacity)	Indoor Air Temp. °F (°C) DB	Outdoor Air Temp. °F (°C) WB													
		59.0 (15)		50.0 (10)		42.8 (6)		32.0 (0)		23.0 (-5)		14.0 (-10)		5.0 (-15)	
		Total Capacity (BTU/h)	Input Power (kW)	Total Capacity (BTU/h)	Input Power (kW)	Total Capacity (BTU/h)	Input Power (kW)	Total Capacity (BTU/h)	Input Power (kW)	Total Capacity (BTU/h)	Input Power (kW)	Total Capacity (BTU/h)	Input Power (kW)	Total Capacity (BTU/h)	Input Power (kW)
2.5 + 2.5	60.8 (16)	47029.83	1.59	32925.67	1.96	26123.05	2.18	21682.57	2.37	19895.72	2.47	19209.66	2.45	17300.44	2.34
	64.4 (18)	46682.89	1.65	32117.64	1.99	25003.53	2.19	20308.31	2.38	18512.10	2.50	18153.05	2.51	16955.10	2.44
	68.0 (20)	46335.96	1.71	31309.61	2.02	23884.00	2.21	18934.04	2.39	17128.48	2.53	17096.44	2.57	16609.76	2.54
	69.8 (21)	45824.02	1.75	30621.38	2.04	23429.17	2.23	19014.83	2.40	17857.45	2.53	18057.00	2.57	17236.75	2.54
	71.6 (22)	45312.08	1.79	29933.16	2.07	22974.34	2.24	19095.62	2.41	18586.43	2.53	19017.57	2.57	17863.74	2.55
	75.2 (24)	44288.20	1.87	28556.70	2.12	22064.67	2.28	19257.20	2.43	20044.38	2.54	20938.69	2.57	19117.72	2.56
2.5 + 3.2	60.8 (16)	51732.81	1.75	36218.23	2.15	28735.36	2.39	23850.82	2.60	21885.29	2.72	21130.63	2.70	19030.48	2.58
	64.4 (18)	51351.18	1.82	35329.40	2.18	27503.88	2.41	22339.14	2.62	20363.31	2.75	19968.36	2.76	18650.61	2.68
	68.0 (20)	50969.56	1.89	34440.57	2.22	26272.40	2.43	20827.45	2.63	18841.33	2.78	18806.09	2.82	18270.73	2.79
	69.8 (21)	50406.42	1.93	33683.52	2.24	25772.09	2.45	20916.32	2.64	19643.20	2.78	19862.70	2.82	18960.42	2.80
	71.6 (22)	49843.29	1.97	32926.47	2.27	25271.77	2.47	21005.19	2.65	20445.07	2.79	20919.32	2.83	19650.11	2.80
	75.2 (24)	48717.02	2.05	31412.37	2.33	24271.14	2.50	21182.92	2.67	22048.82	2.79	23032.56	2.83	21029.49	2.81
2.5 + 5.0	60.8 (16)	53748.37	1.69	37629.33	2.07	29854.91	2.30	24780.08	2.51	22737.96	2.62	21953.90	2.60	19771.93	2.48
	64.4 (18)	53351.88	1.75	36705.87	2.10	28575.46	2.32	23209.49	2.52	21156.68	2.65	20746.34	2.66	19377.25	2.58
	68.0 (20)	52955.39	1.82	35782.41	2.13	27296.00	2.34	21638.91	2.53	19575.40	2.68	19538.79	2.72	18982.58	2.69
	69.8 (21)	52370.31	1.86	34995.87	2.16	26776.19	2.36	21731.24	2.54	20408.52	2.68	20636.58	2.72	19699.14	2.69
	71.6 (22)	51785.24	1.90	34209.32	2.19	26256.38	2.37	21823.57	2.55	21241.63	2.68	21734.36	2.72	20415.70	2.70
	75.2 (24)	50615.08	1.98	32636.23	2.24	25216.77	2.41	22008.23	2.57	22907.87	2.69	23929.93	2.73	21848.82	2.71
3.2 + 3.2	60.8 (16)	53748.37	1.80	37629.33	2.21	29854.91	2.46	24780.08	2.68	22737.96	2.80	21953.90	2.78	19771.93	2.65
	64.4 (18)	53351.88	1.87	36705.87	2.25	28575.46	2.48	23209.49	2.69	21156.68	2.83	20746.34	2.84	19377.25	2.76
	68.0 (20)	52955.39	1.94	35782.41	2.28	27296.00	2.50	21638.91	2.71	19575.40	2.86	19538.79	2.90	18982.58	2.87
	69.8 (21)	52370.31	1.98	34995.87	2.31	26776.19	2.52	21731.24	2.72	20408.52	2.86	20636.58	2.91	19699.14	2.88
	71.6 (22)	51785.24	2.03	34209.32	2.34	26256.38	2.54	21823.57	2.73	21241.63	2.87	21734.36	2.91	20415.70	2.88
	75.2 (24)	50615.08	2.11	32636.23	2.39	25216.77	2.57	22008.23	2.75	22907.87	2.87	23929.93	2.91	21848.82	2.89
3.2 + 5.0	60.8 (16)	53748.37	1.63	37629.33	2.00	29854.91	2.23	24780.08	2.42	22737.96	2.53	21953.90	2.51	19771.93	2.40
	64.4 (18)	53351.88	1.69	36705.87	2.03	28575.46	2.24	23209.49	2.43	21156.68	2.56	20746.34	2.57	19377.25	2.50
	68.0 (20)	52955.39	1.75	35782.41	2.06	27296.00	2.26	21638.91	2.45	19575.40	2.58	19538.79	2.62	18982.58	2.60
	69.8 (21)	52370.31	1.79	34995.87	2.09	26776.19	2.28	21731.24	2.46	20408.52	2.59	20636.58	2.63	19699.14	2.60
	71.6 (22)	51785.24	1.83	34209.32	2.11	26256.38	2.29	21823.57	2.46	21241.63	2.59	21734.36	2.63	20415.70	2.61
	75.2 (24)	50615.08	1.91	32636.23	2.16	25216.77	2.33	22008.23	2.48	22907.87	2.60	23929.93	2.63	21848.82	2.61
1.6 + 1.6 + 1.6	60.8 (16)	54420.23	1.64	38099.70	2.02	30228.10	2.25	25089.83	2.44	23022.19	2.55	22228.32	2.53	20019.08	2.42
	64.4 (18)	54018.78	1.71	37164.70	2.05	28932.65	2.26	23499.61	2.46	21421.14	2.58	21005.67	2.59	19619.47	2.52
	68.0 (20)	53617.33	1.77	36229.69	2.08	27637.20	2.28	21909.39	2.47	19820.10	2.61	19783.02	2.65	19219.86	2.62
	69.8 (21)	53024.94	1.81	35433.31	2.11	27110.89	2.30	22002.88	2.48	20663.63	2.61	20894.53	2.65	19945.38	2.62
	71.6 (22)	52432.55	1.85	34636.94	2.13	26584.59	2.31	22096.36	2.49	21507.16	2.61	22006.04	2.65	20670.89	2.63
	75.2 (24)	51247.77	1.93	33044.18	2.18	25531.98	2.35	22283.33	2.50	23194.21	2.62	24229.06	2.66	22121.93	2.64

Combination (Capacity)	Indoor Air Temp. °F (°C) DB	Outdoor Air Temp. °F (°C) WB													
		59.0 (15)		50.0 (10)		42.8 (6)		32.0 (0)		23.0 (-5)		14.0 (-10)		5.0 (-15)	
		Total Capacity (BTU/h)	Input Power (kW)	Total Capacity (BTU/h)	Input Power (kW)	Total Capacity (BTU/h)	Input Power (kW)	Total Capacity (BTU/h)	Input Power (kW)	Total Capacity (BTU/h)	Input Power (kW)	Total Capacity (BTU/h)	Input Power (kW)	Total Capacity (BTU/h)	Input Power (kW)
1.6 + 1.6 + 2.0	60.8 (16)	55763.94	1.67	39040.43	2.05	30974.47	2.29	25709.33	2.49	23590.64	2.60	22777.17	2.58	20513.38	2.46
	64.4 (18)	55352.58	1.74	38082.34	2.08	29647.04	2.30	24079.85	2.50	21950.06	2.62	21524.33	2.64	20103.90	2.56
	68.0 (20)	54941.21	1.80	37124.25	2.12	28319.60	2.32	22450.37	2.51	20309.48	2.65	20271.49	2.69	19694.42	2.67
	69.8 (21)	54334.20	1.84	36308.21	2.14	27780.30	2.34	22546.16	2.52	21173.84	2.66	21410.45	2.70	20437.86	2.67
	71.6 (22)	53727.18	1.88	35492.17	2.17	27241.00	2.35	22641.95	2.53	22038.20	2.66	22549.40	2.70	21181.29	2.67
	75.2 (24)	52513.15	1.96	33860.09	2.22	26162.40	2.39	22833.54	2.55	23766.91	2.67	24827.30	2.70	22668.15	2.68
1.6 + 1.6 + 2.5	60.8 (16)	55763.94	1.67	39040.43	2.05	30974.47	2.29	25709.33	2.49	23590.64	2.60	22777.17	2.58	20513.38	2.46
	64.4 (18)	55352.58	1.74	38082.34	2.08	29647.04	2.30	24079.85	2.50	21950.06	2.62	21524.33	2.64	20103.90	2.56
	68.0 (20)	54941.21	1.80	37124.25	2.12	28319.60	2.32	22450.37	2.51	20309.48	2.65	20271.49	2.69	19694.42	2.67
	69.8 (21)	54334.20	1.84	36308.21	2.14	27780.30	2.34	22546.16	2.52	21173.84	2.66	21410.45	2.70	20437.86	2.67
	71.6 (22)	53727.18	1.88	35492.17	2.17	27241.00	2.35	22641.95	2.53	22038.20	2.66	22549.40	2.70	21181.29	2.67
	75.2 (24)	52513.15	1.96	33860.09	2.22	26162.40	2.39	22833.54	2.55	23766.91	2.67	24827.30	2.70	22668.15	2.68
1.6 + 1.6 + 3.2	60.8 (16)	55763.94	1.64	39040.43	2.02	30974.47	2.25	25709.33	2.44	23590.64	2.55	22777.17	2.53	20513.38	2.42
	64.4 (18)	55352.58	1.71	38082.34	2.05	29647.04	2.26	24079.85	2.46	21950.06	2.58	21524.33	2.59	20103.90	2.52
	68.0 (20)	54941.21	1.77	37124.25	2.08	28319.60	2.28	22450.37	2.47	20309.48	2.61	20271.49	2.65	19694.42	2.62
	69.8 (21)	54334.20	1.81	36308.21	2.11	27780.30	2.30	22546.16	2.48	21173.84	2.61	21410.45	2.65	20437.86	2.62
	71.6 (22)	53727.18	1.85	35492.17	2.13	27241.00	2.31	22641.95	2.49	22038.20	2.61	22549.40	2.65	21181.29	2.63
	75.2 (24)	52513.15	1.93	33860.09	2.18	26162.40	2.35	22833.54	2.50	23766.91	2.62	24827.30	2.66	22668.15	2.64
1.6 + 1.6 + 5.0	60.8 (16)	55763.94	1.56	39040.43	1.91	30974.47	2.13	25709.33	2.31	23590.64	2.42	22777.17	2.40	20513.38	2.29
	64.4 (18)	55352.58	1.62	38082.34	1.94	29647.04	2.14	24079.85	2.33	21950.06	2.44	21524.33	2.45	20103.90	2.39
	68.0 (20)	54941.21	1.68	37124.25	1.97	28319.60	2.16	22450.37	2.34	20309.48	2.47	20271.49	2.51	19694.42	2.48
	69.8 (21)	54334.20	1.71	36308.21	1.99	27780.30	2.18	22546.16	2.35	21173.84	2.47	21410.45	2.51	20437.86	2.49
	71.6 (22)	53727.18	1.75	35492.17	2.02	27241.00	2.19	22641.95	2.36	22038.20	2.48	22549.40	2.51	21181.29	2.49
	75.2 (24)	52513.15	1.82	33860.09	2.07	26162.40	2.22	22833.54	2.37	23766.91	2.48	24827.30	2.52	22668.15	2.50
1.6 + 2.0 + 2.0	60.8 (16)	55763.94	1.66	39040.43	2.04	30974.47	2.27	25709.33	2.46	23590.64	2.57	22777.17	2.55	20513.38	2.44
	64.4 (18)	55352.58	1.72	38082.34	2.07	29647.04	2.28	24079.85	2.48	21950.06	2.60	21524.33	2.61	20103.90	2.54
	68.0 (20)	54941.21	1.78	37124.25	2.10	28319.60	2.30	22450.37	2.49	20309.48	2.63	20271.49	2.67	19694.42	2.64
	69.8 (21)	54334.20	1.82	36308.21	2.12	27780.30	2.32	22546.16	2.50	21173.84	2.63	21410.45	2.67	20437.86	2.65
	71.6 (22)	53727.18	1.86	35492.17	2.15	27241.00	2.33	22641.95	2.51	22038.20	2.64	22549.40	2.67	21181.29	2.65
	75.2 (24)	52513.15	1.94	33860.09	2.20	26162.40	2.37	22833.54	2.53	23766.91	2.64	24827.30	2.68	22668.15	2.66
1.6 + 2.0 + 2.5	60.8 (16)	55763.94	1.66	39040.43	2.04	30974.47	2.27	25709.33	2.46	23590.64	2.57	22777.17	2.55	20513.38	2.44
	64.4 (18)	55352.58	1.72	38082.34	2.07	29647.04	2.28	24079.85	2.48	21950.06	2.60	21524.33	2.61	20103.90	2.54
	68.0 (20)	54941.21	1.78	37124.25	2.10	28319.60	2.30	22450.37	2.49	20309.48	2.63	20271.49	2.67	19694.42	2.64
	69.8 (21)	54334.20	1.82	36308.21	2.12	27780.30	2.32	22546.16	2.50	21173.84	2.63	21410.45	2.67	20437.86	2.65
	71.6 (22)	53727.18	1.86	35492.17	2.15	27241.00	2.33	22641.95	2.51	22038.20	2.64	22549.40	2.67	21181.29	2.65
	75.2 (24)	52513.15	1.94	33860.09	2.20	26162.40	2.37	22833.54	2.53	23766.91	2.64	24827.30	2.68	22668.15	2.66

Combination (Capacity)	Indoor Air Temp. °F (°C) DB	Outdoor Air Temp. °F (°C) WB													
		59.0 (15)		50.0 (10)		42.8 (6)		32.0 (0)		23.0 (-5)		14.0 (-10)		5.0 (-15)	
		Total Capacity (BTU/h)	Input Power (kW)	Total Capacity (BTU/h)	Input Power (kW)	Total Capacity (BTU/h)	Input Power (kW)	Total Capacity (BTU/h)	Input Power (kW)	Total Capacity (BTU/h)	Input Power (kW)	Total Capacity (BTU/h)	Input Power (kW)	Total Capacity (BTU/h)	Input Power (kW)
1.6 + 2.0 + 3.2	60.8 (16)	55763.94	1.64	39040.43	2.01	30974.47	2.24	25709.33	2.43	23590.64	2.54	22777.17	2.52	20513.38	2.41
	64.4 (18)	55352.58	1.70	38082.34	2.04	29647.04	2.25	24079.85	2.45	21950.06	2.57	21524.33	2.58	20103.90	2.51
	68.0 (20)	54941.21	1.76	37124.25	2.07	28319.60	2.27	22450.37	2.46	20309.48	2.60	20271.49	2.64	19694.42	2.61
	69.8 (21)	54334.20	1.80	36308.21	2.10	27780.30	2.29	22546.16	2.47	21173.84	2.60	21410.45	2.64	20437.86	2.61
	71.6 (22)	53727.18	1.84	35492.17	2.12	27241.00	2.30	22641.95	2.48	22038.20	2.60	22549.40	2.64	21181.29	2.62
	75.2 (24)	52513.15	1.92	33860.09	2.17	26162.40	2.34	22833.54	2.49	23766.91	2.61	24827.30	2.64	22668.15	2.62
1.6 + 2.0 + 5.0	60.8 (16)	55763.94	1.55	39040.43	1.90	30974.47	2.12	25709.33	2.30	23590.64	2.40	22777.17	2.39	20513.38	2.28
	64.4 (18)	55352.58	1.61	38082.34	1.93	29647.04	2.13	24079.85	2.32	21950.06	2.43	21524.33	2.44	20103.90	2.38
	68.0 (20)	54941.21	1.67	37124.25	1.96	28319.60	2.15	22450.37	2.33	20309.48	2.46	20271.49	2.50	19694.42	2.47
	69.8 (21)	54334.20	1.71	36308.21	1.99	27780.30	2.17	22546.16	2.34	21173.84	2.46	21410.45	2.50	20437.86	2.48
	71.6 (22)	53727.18	1.74	35492.17	2.01	27241.00	2.18	22641.95	2.34	22038.20	2.46	22549.40	2.50	21181.29	2.48
	75.2 (24)	52513.15	1.82	33860.09	2.06	26162.40	2.21	22833.54	2.36	23766.91	2.47	24827.30	2.50	22668.15	2.49
1.6 + 2.5 + 2.5	60.8 (16)	55763.94	1.66	39040.43	2.04	30974.47	2.27	25709.33	2.46	23590.64	2.57	22777.17	2.55	20513.38	2.44
	64.4 (18)	55352.58	1.72	38082.34	2.07	29647.04	2.28	24079.85	2.48	21950.06	2.60	21524.33	2.61	20103.90	2.54
	68.0 (20)	54941.21	1.78	37124.25	2.10	28319.60	2.30	22450.37	2.49	20309.48	2.63	20271.49	2.67	19694.42	2.64
	69.8 (21)	54334.20	1.82	36308.21	2.12	27780.30	2.32	22546.16	2.50	21173.84	2.63	21410.45	2.67	20437.86	2.65
	71.6 (22)	53727.18	1.86	35492.17	2.15	27241.00	2.33	22641.95	2.51	22038.20	2.64	22549.40	2.67	21181.29	2.65
	75.2 (24)	52513.15	1.94	33860.09	2.20	26162.40	2.37	22833.54	2.53	23766.91	2.64	24827.30	2.68	22668.15	2.66
1.6 + 2.5 + 3.2	60.8 (16)	55763.94	1.64	39040.43	2.01	30974.47	2.24	25709.33	2.43	23590.64	2.54	22777.17	2.52	20513.38	2.41
	64.4 (18)	55352.58	1.70	38082.34	2.04	29647.04	2.25	24079.85	2.45	21950.06	2.57	21524.33	2.58	20103.90	2.51
	68.0 (20)	54941.21	1.76	37124.25	2.07	28319.60	2.27	22450.37	2.46	20309.48	2.60	20271.49	2.64	19694.42	2.61
	69.8 (21)	54334.20	1.80	36308.21	2.10	27780.30	2.29	22546.16	2.47	21173.84	2.60	21410.45	2.64	20437.86	2.61
	71.6 (22)	53727.18	1.84	35492.17	2.12	27241.00	2.30	22641.95	2.48	22038.20	2.60	22549.40	2.64	21181.29	2.62
	75.2 (24)	52513.15	1.92	33860.09	2.17	26162.40	2.34	22833.54	2.49	23766.91	2.61	24827.30	2.64	22668.15	2.62
1.6 + 3.2 + 3.2	60.8 (16)	55763.94	1.62	39040.43	1.98	30974.47	2.21	25709.33	2.40	23590.64	2.51	22777.17	2.49	20513.38	2.37
	64.4 (18)	55352.58	1.68	38082.34	2.01	29647.04	2.22	24079.85	2.41	21950.06	2.53	21524.33	2.54	20103.90	2.47
	68.0 (20)	54941.21	1.74	37124.25	2.04	28319.60	2.24	22450.37	2.43	20309.48	2.56	20271.49	2.60	19694.42	2.57
	69.8 (21)	54334.20	1.78	36308.21	2.07	27780.30	2.26	22546.16	2.43	21173.84	2.56	21410.45	2.60	20437.86	2.58
	71.6 (22)	53727.18	1.82	35492.17	2.09	27241.00	2.27	22641.95	2.44	22038.20	2.57	22549.40	2.61	21181.29	2.58
	75.2 (24)	52513.15	1.89	33860.09	2.14	26162.40	2.31	22833.54	2.46	23766.91	2.57	24827.30	2.61	22668.15	2.59
2.0 + 2.0 + 2.0	60.8 (16)	55763.94	1.65	39040.43	2.03	30974.47	2.26	25709.33	2.45	23590.64	2.56	22777.17	2.54	20513.38	2.43
	64.4 (18)	55352.58	1.71	38082.34	2.06	29647.04	2.27	24079.85	2.47	21950.06	2.59	21524.33	2.60	20103.90	2.53
	68.0 (20)	54941.21	1.78	37124.25	2.09	28319.60	2.29	22450.37	2.48	20309.48	2.62	20271.49	2.66	19694.42	2.63
	69.8 (21)	54334.20	1.82	36308.21	2.11	27780.30	2.31	22546.16	2.49	21173.84	2.62	21410.45	2.66	20437.86	2.64
	71.6 (22)	53727.18	1.86	35492.17	2.14	27241.00	2.32	22641.95	2.50	22038.20	2.63	22549.40	2.66	21181.29	2.64
	75.2 (24)	52513.15	1.93	33860.09	2.19	26162.40	2.36	22833.54	2.52	23766.91	2.63	24827.30	2.67	22668.15	2.65

Combination (Capacity)	Indoor Air Temp. °F (°C) DB	Outdoor Air Temp. °F (°C) WB													
		59.0 (15)		50.0 (10)		42.8 (6)		32.0 (0)		23.0 (-5)		14.0 (-10)		5.0 (-15)	
		Total Capacity (BTU/h)	Input Power (kW)	Total Capacity (BTU/h)	Input Power (kW)	Total Capacity (BTU/h)	Input Power (kW)	Total Capacity (BTU/h)	Input Power (kW)	Total Capacity (BTU/h)	Input Power (kW)	Total Capacity (BTU/h)	Input Power (kW)	Total Capacity (BTU/h)	Input Power (kW)
2.0 + 2.0 + 2.5	60.8 (16)	55763.94	1.65	39040.43	2.03	30974.47	2.26	25709.33	2.45	23590.64	2.56	22777.17	2.54	20513.38	2.43
	64.4 (18)	55352.58	1.71	38082.34	2.06	29647.04	2.27	24079.85	2.47	21950.06	2.59	21524.33	2.60	20103.90	2.53
	68.0 (20)	54941.21	1.78	37124.25	2.09	28319.60	2.29	22450.37	2.48	20309.48	2.62	20271.49	2.66	19694.42	2.63
	69.8 (21)	54334.20	1.82	36308.21	2.11	27780.30	2.31	22546.16	2.49	21173.84	2.62	21410.45	2.66	20437.86	2.64
	71.6 (22)	53727.18	1.86	35492.17	2.14	27241.00	2.32	22641.95	2.50	22038.20	2.63	22549.40	2.66	21181.29	2.64
	75.2 (24)	52513.15	1.93	33860.09	2.19	26162.40	2.36	22833.54	2.52	23766.91	2.63	24827.30	2.67	22668.15	2.65
2.0 + 2.0 + 3.2	60.8 (16)	55763.94	1.63	39040.43	2.00	30974.47	2.23	25709.33	2.42	23590.64	2.53	22777.17	2.51	20513.38	2.40
	64.4 (18)	55352.58	1.69	38082.34	2.03	29647.04	2.24	24079.85	2.43	21950.06	2.56	21524.33	2.57	20103.90	2.50
	68.0 (20)	54941.21	1.75	37124.25	2.06	28319.60	2.26	22450.37	2.45	20309.48	2.58	20271.49	2.62	19694.42	2.60
	69.8 (21)	54334.20	1.79	36308.21	2.09	27780.30	2.28	22546.16	2.46	21173.84	2.59	21410.45	2.63	20437.86	2.60
	71.6 (22)	53727.18	1.83	35492.17	2.11	27241.00	2.29	22641.95	2.46	22038.20	2.59	22549.40	2.63	21181.29	2.61
	75.2 (24)	52513.15	1.91	33860.09	2.16	26162.40	2.33	22833.54	2.48	23766.91	2.60	24827.30	2.63	22668.15	2.61
2.0 + 2.0 + 5.0	60.8 (16)	55763.94	1.54	39040.43	1.89	30974.47	2.11	25709.33	2.29	23590.64	2.39	22777.17	2.38	20513.38	2.27
	64.4 (18)	55352.58	1.60	38082.34	1.92	29647.04	2.12	24079.85	2.31	21950.06	2.42	21524.33	2.43	20103.90	2.36
	68.0 (20)	54941.21	1.66	37124.25	1.95	28319.60	2.14	22450.37	2.32	20309.48	2.45	20271.49	2.49	19694.42	2.46
	69.8 (21)	54334.20	1.70	36308.21	1.98	27780.30	2.16	22546.16	2.33	21173.84	2.45	21410.45	2.49	20437.86	2.46
	71.6 (22)	53727.18	1.73	35492.17	2.00	27241.00	2.17	22641.95	2.33	22038.20	2.45	22549.40	2.49	21181.29	2.47
	75.2 (24)	52513.15	1.81	33860.09	2.05	26162.40	2.20	22833.54	2.35	23766.91	2.46	24827.30	2.49	22668.15	2.47
2.0 + 2.5 + 2.5	60.8 (16)	55763.94	1.65	39040.43	2.03	30974.47	2.26	25709.33	2.45	23590.64	2.56	22777.17	2.54	20513.38	2.43
	64.4 (18)	55352.58	1.71	38082.34	2.06	29647.04	2.27	24079.85	2.47	21950.06	2.59	21524.33	2.60	20103.90	2.53
	68.0 (20)	54941.21	1.78	37124.25	2.09	28319.60	2.29	22450.37	2.48	20309.48	2.62	20271.49	2.66	19694.42	2.63
	69.8 (21)	54334.20	1.82	36308.21	2.11	27780.30	2.31	22546.16	2.49	21173.84	2.62	21410.45	2.66	20437.86	2.64
	71.6 (22)	53727.18	1.86	35492.17	2.14	27241.00	2.32	22641.95	2.50	22038.20	2.63	22549.40	2.66	21181.29	2.64
	75.2 (24)	52513.15	1.93	33860.09	2.19	26162.40	2.36	22833.54	2.52	23766.91	2.63	24827.30	2.67	22668.15	2.65
2.0 + 2.5 + 3.2	60.8 (16)	55763.94	1.63	39040.43	2.00	30974.47	2.23	25709.33	2.42	23590.64	2.53	22777.17	2.51	20513.38	2.40
	64.4 (18)	55352.58	1.69	38082.34	2.03	29647.04	2.24	24079.85	2.43	21950.06	2.56	21524.33	2.57	20103.90	2.50
	68.0 (20)	54941.21	1.75	37124.25	2.06	28319.60	2.26	22450.37	2.45	20309.48	2.58	20271.49	2.62	19694.42	2.60
	69.8 (21)	54334.20	1.79	36308.21	2.09	27780.30	2.28	22546.16	2.46	21173.84	2.59	21410.45	2.63	20437.86	2.60
	71.6 (22)	53727.18	1.83	35492.17	2.11	27241.00	2.29	22641.95	2.46	22038.20	2.59	22549.40	2.63	21181.29	2.61
	75.2 (24)	52513.15	1.91	33860.09	2.16	26162.40	2.33	22833.54	2.48	23766.91	2.60	24827.30	2.63	22668.15	2.61
2.0 + 3.2 + 3.2	60.8 (16)	55763.94	1.61	39040.43	1.97	30974.47	2.20	25709.33	2.39	23590.64	2.49	22777.17	2.48	20513.38	2.36
	64.4 (18)	55352.58	1.67	38082.34	2.00	29647.04	2.21	24079.85	2.40	21950.06	2.52	21524.33	2.53	20103.90	2.46
	68.0 (20)	54941.21	1.73	37124.25	2.03	28319.60	2.23	22450.37	2.42	20309.48	2.55	20271.49	2.59	19694.42	2.56
	69.8 (21)	54334.20	1.77	36308.21	2.06	27780.30	2.25	22546.16	2.42	21173.84	2.55	21410.45	2.59	20437.86	2.57
	71.6 (22)	53727.18	1.81	35492.17	2.08	27241.00	2.26	22641.95	2.43	22038.20	2.56	22549.40	2.59	21181.29	2.57
	75.2 (24)	52513.15	1.88	33860.09	2.13	26162.40	2.30	22833.54	2.45	23766.91	2.56	24827.30	2.60	22668.15	2.58

Combination (Capacity)	Indoor Air Temp. °F (°C) DB	Outdoor Air Temp. °F (°C) WB													
		59.0 (15)		50.0 (10)		42.8 (6)		32.0 (0)		23.0 (-5)		14.0 (-10)		5.0 (-15)	
		Total Capacity (BTU/h)	Input Power (kW)	Total Capacity (BTU/h)	Input Power (kW)	Total Capacity (BTU/h)	Input Power (kW)	Total Capacity (BTU/h)	Input Power (kW)	Total Capacity (BTU/h)	Input Power (kW)	Total Capacity (BTU/h)	Input Power (kW)	Total Capacity (BTU/h)	Input Power (kW)
2.5 + 2.5 + 2.5	60.8 (16)	55763.94	1.65	39040.43	2.03	30974.47	2.26	25709.33	2.45	23590.64	2.56	22777.17	2.54	20513.38	2.43
	64.4 (18)	55352.58	1.71	38082.34	2.06	29647.04	2.27	24079.85	2.47	21950.06	2.59	21524.33	2.60	20103.90	2.53
	68.0 (20)	54941.21	1.78	37124.25	2.09	28319.60	2.29	22450.37	2.48	20309.48	2.62	20271.49	2.66	19694.42	2.63
	69.8 (21)	54334.20	1.82	36308.21	2.11	27780.30	2.31	22546.16	2.49	21173.84	2.62	21410.45	2.66	20437.86	2.64
	71.6 (22)	53727.18	1.86	35492.17	2.14	27241.00	2.32	22641.95	2.50	22038.20	2.63	22549.40	2.66	21181.29	2.64
	75.2 (24)	52513.15	1.93	33860.09	2.19	26162.40	2.36	22833.54	2.52	23766.91	2.63	24827.30	2.67	22668.15	2.65
2.5 + 2.5 + 3.2	60.8 (16)	55763.94	1.63	39040.43	2.00	30974.47	2.23	25709.33	2.42	23590.64	2.53	22777.17	2.51	20513.38	2.40
	64.4 (18)	55352.58	1.69	38082.34	2.03	29647.04	2.24	24079.85	2.43	21950.06	2.56	21524.33	2.57	20103.90	2.50
	68.0 (20)	54941.21	1.75	37124.25	2.06	28319.60	2.26	22450.37	2.45	20309.48	2.58	20271.49	2.62	19694.42	2.60
	69.8 (21)	54334.20	1.79	36308.21	2.09	27780.30	2.28	22546.16	2.46	21173.84	2.59	21410.45	2.63	20437.86	2.60
	71.6 (22)	53727.18	1.83	35492.17	2.11	27241.00	2.29	22641.95	2.46	22038.20	2.59	22549.40	2.63	21181.29	2.61
	75.2 (24)	52513.15	1.91	33860.09	2.16	26162.40	2.33	22833.54	2.48	23766.91	2.60	24827.30	2.63	22668.15	2.61
2.5 + 3.2 + 3.2	60.8 (16)	55763.94	1.61	39040.43	1.97	30974.47	2.20	25709.33	2.39	23590.64	2.49	22777.17	2.48	20513.38	2.36
	64.4 (18)	55352.58	1.67	38082.34	2.00	29647.04	2.21	24079.85	2.40	21950.06	2.52	21524.33	2.53	20103.90	2.46
	68.0 (20)	54941.21	1.73	37124.25	2.03	28319.60	2.23	22450.37	2.42	20309.48	2.55	20271.49	2.59	19694.42	2.56
	69.8 (21)	54334.20	1.77	36308.21	2.06	27780.30	2.25	22546.16	2.42	21173.84	2.55	21410.45	2.59	20437.86	2.57
	71.6 (22)	53727.18	1.81	35492.17	2.08	27241.00	2.26	22641.95	2.43	22038.20	2.56	22549.40	2.59	21181.29	2.57
	75.2 (24)	52513.15	1.88	33860.09	2.13	26162.40	2.30	22833.54	2.45	23766.91	2.56	24827.30	2.60	22668.15	2.58

17.2 CU-4E24RBU

17.2.1 Operation Characteristics

17.2.1.1 One Indoor Unit Operation

- Cooling Characteristic
[Condition] Room temperature: 80.0°F (26.7°C) (DBT), 67.0°F (19.4°C) (WBT)
Operation condition: High fan speed
Piping Length: 7.5m (24.6 ft)
230V 60Hz

A) Indoor unit capacity: Cooling (2.0: CS-ME7RKUA), service mode frequency = 20Hz

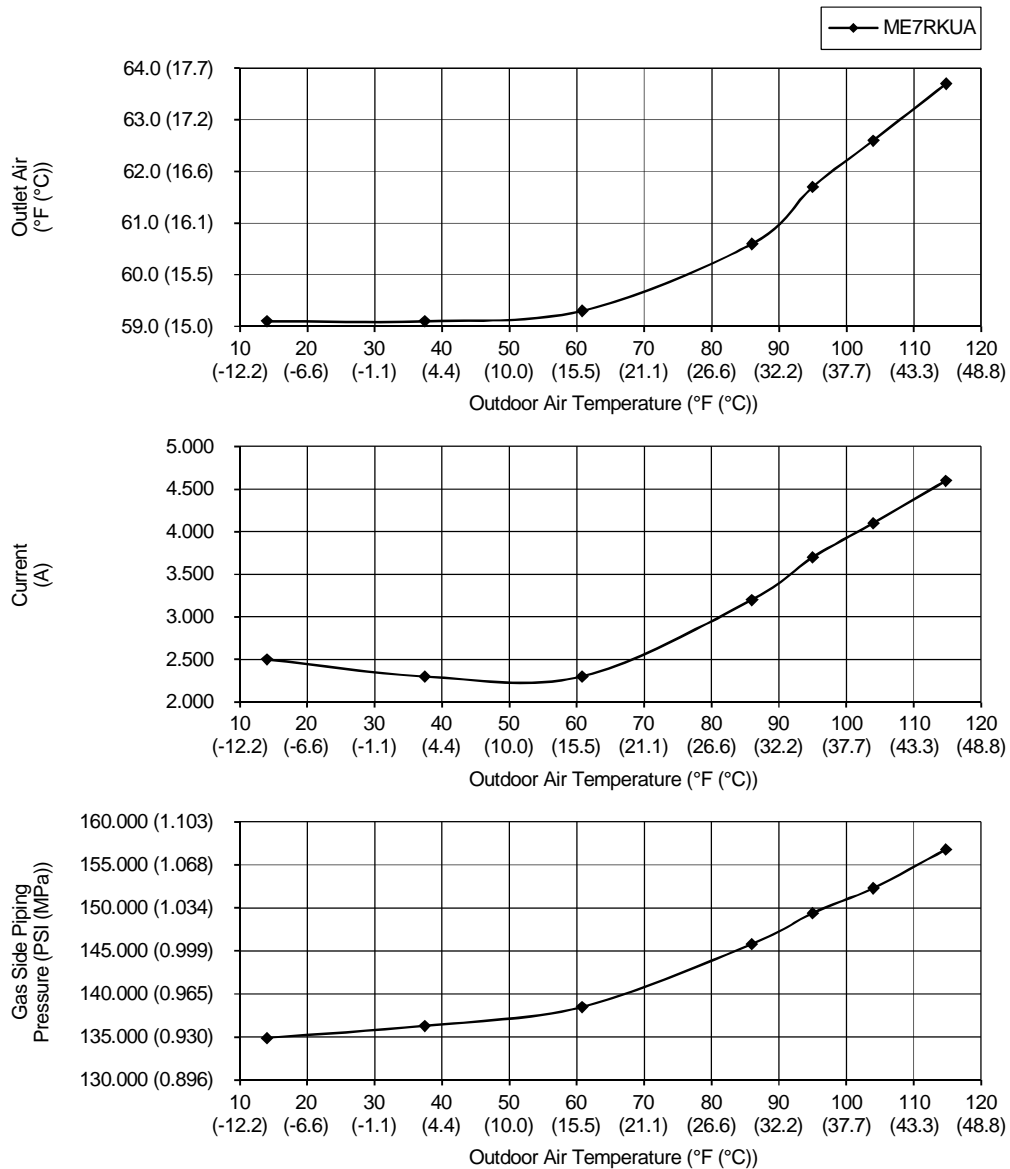

- Cooling Characteristic

[Condition] Room temperature: 80.0°F (26.7°C) (DBT), 67.0°F (19.4°C) (WBT)

Operation condition: High fan speed

Piping Length: 7.5m (24.6 ft)

230V 60Hz

B) Indoor unit capacity: Cooling (2.5: CS-E9RKUAW), service mode frequency = 20Hz

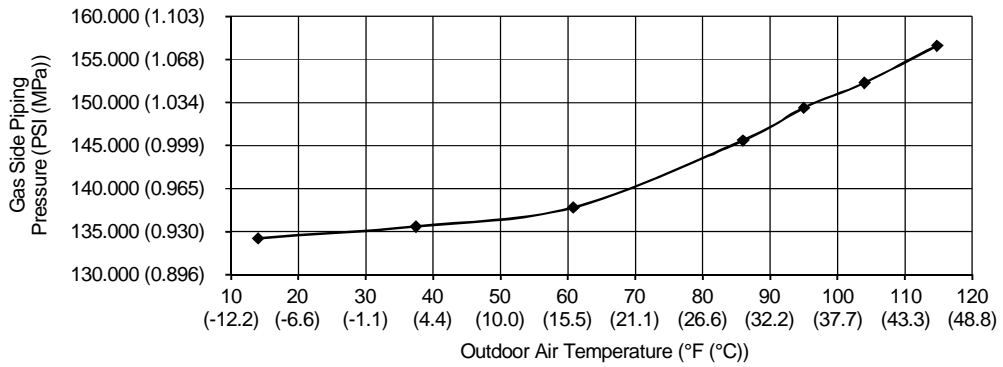
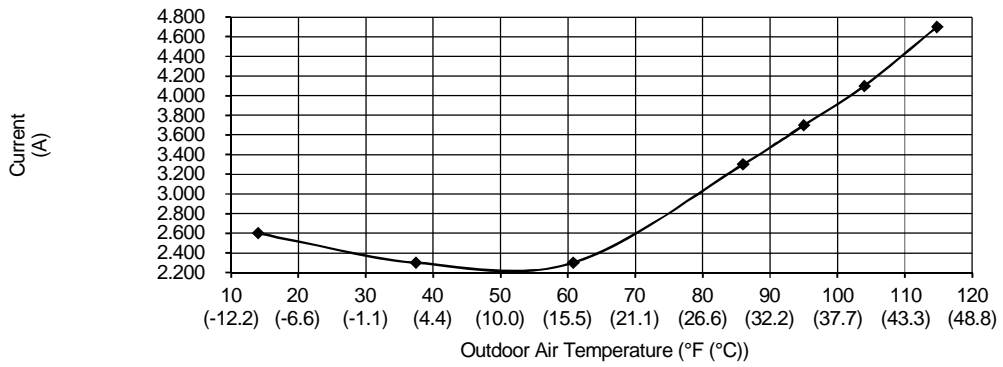
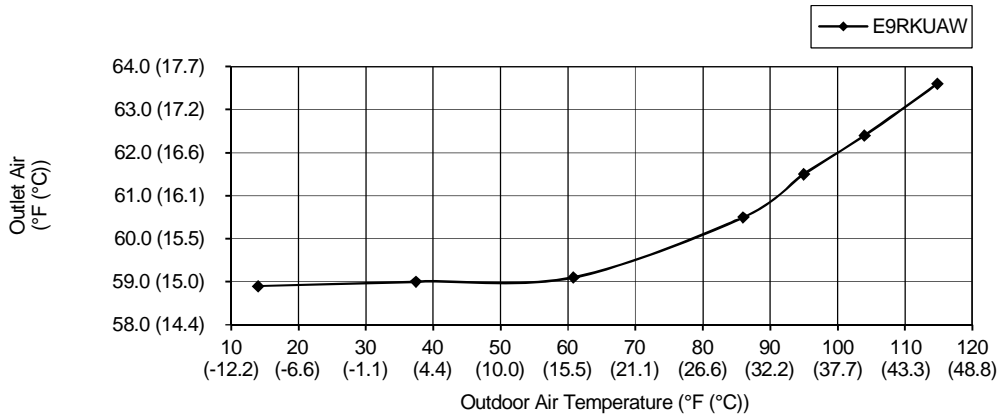

- Cooling Characteristic

[Condition] Room temperature: 80.0°F (26.7°C) (DBT), 67.0°F (19.4°C) (WBT)

Operation condition: High fan speed

Piping Length: 7.5m (24.6 ft)

230V 60Hz

C) Indoor unit capacity: Cooling (3.2: CS-E12RKUAW), service mode frequency = 34Hz

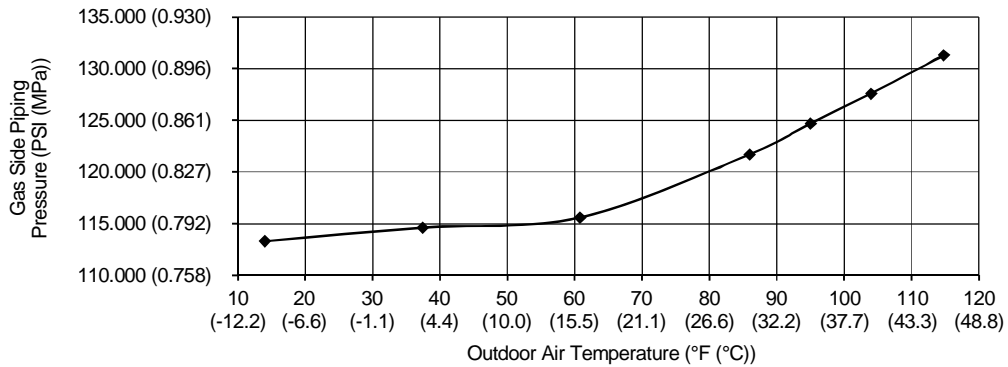
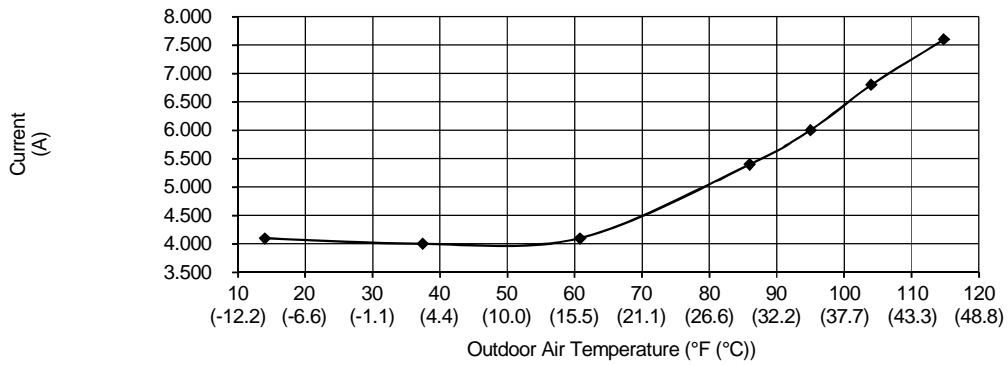
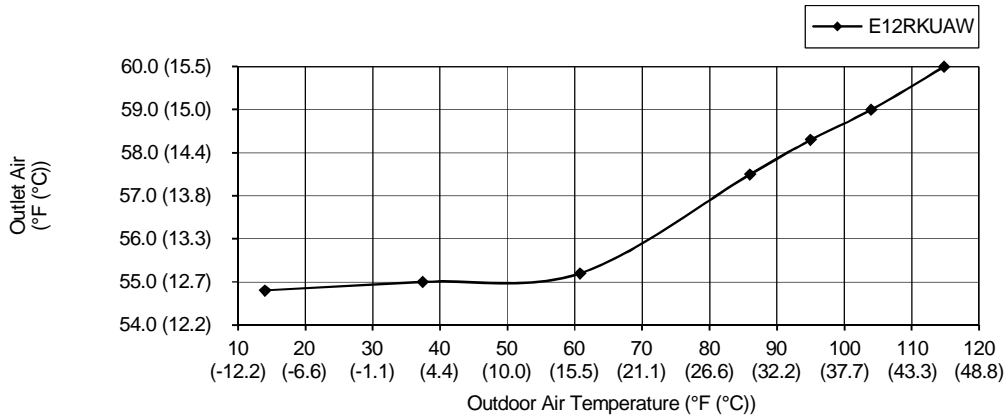

- Cooling Characteristic

[Condition] Room temperature: 80.0°F (26.7°C) (DBT), 67.0°F (19.4°C) (WBT)

Operation condition: High fan speed

Piping Length: 7.5m (24.6 ft)

230V 60Hz

D) Indoor unit capacity: Cooling (5.0: CS-E18RKUAW), service mode frequency = 49Hz

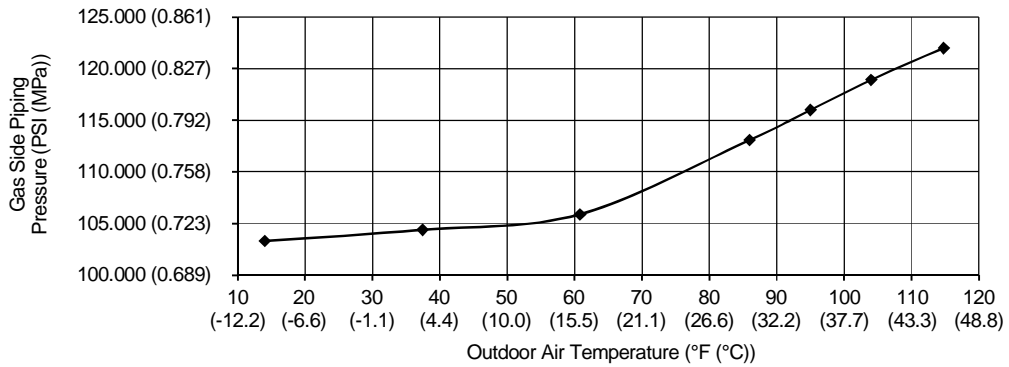
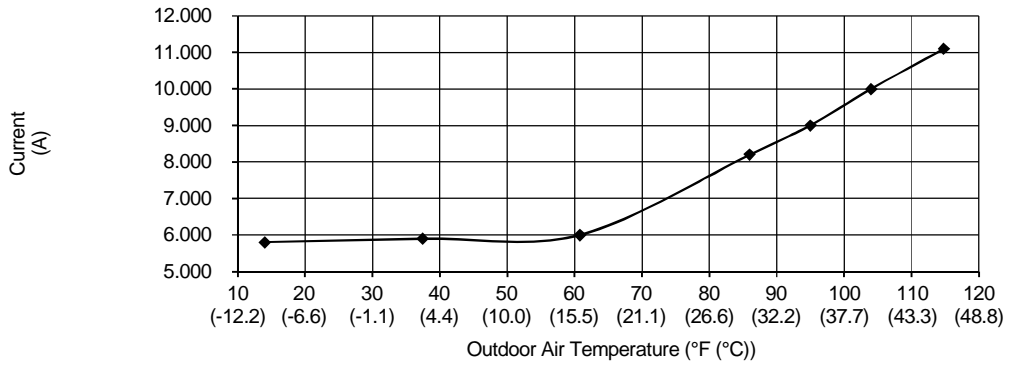
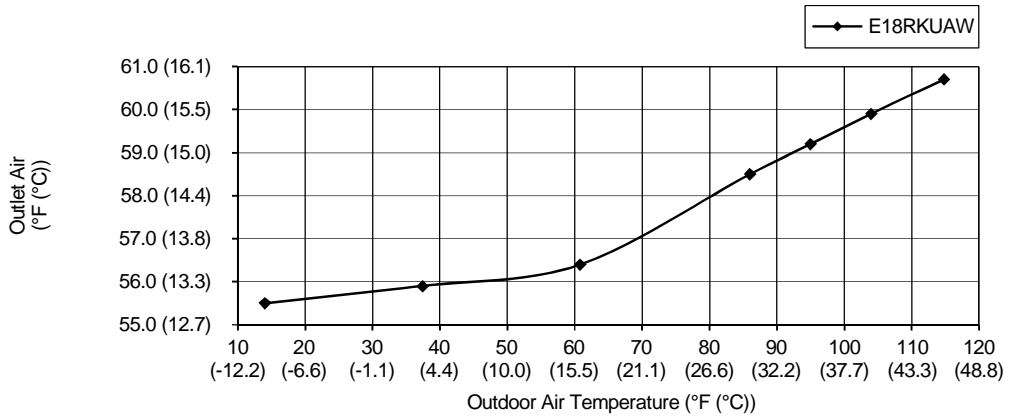

- Heating Characteristic

[Condition] Room temperature: 70.0°F (21.1°C) (DBT), 60.0°F (15.6°C) (WBT)

Operation condition: High fan speed

Piping Length: 7.5m (24.6 ft)

230V 60Hz

A) Indoor unit capacity: Heating (2.0: CS-ME7RKUA), service mode frequency = 39Hz

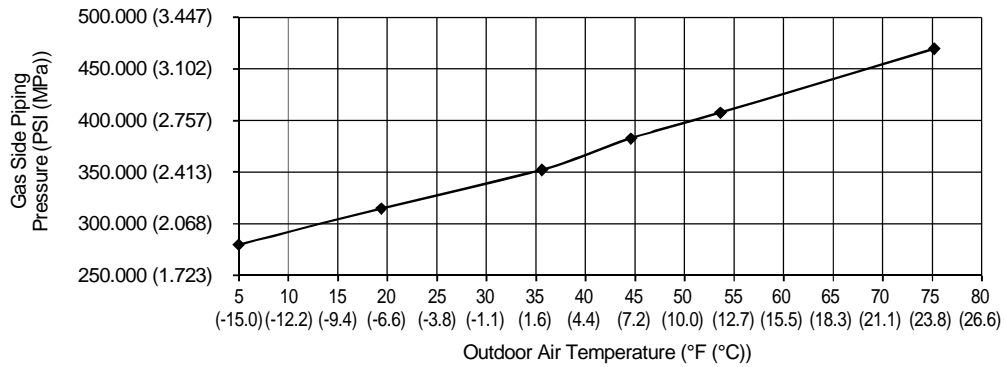
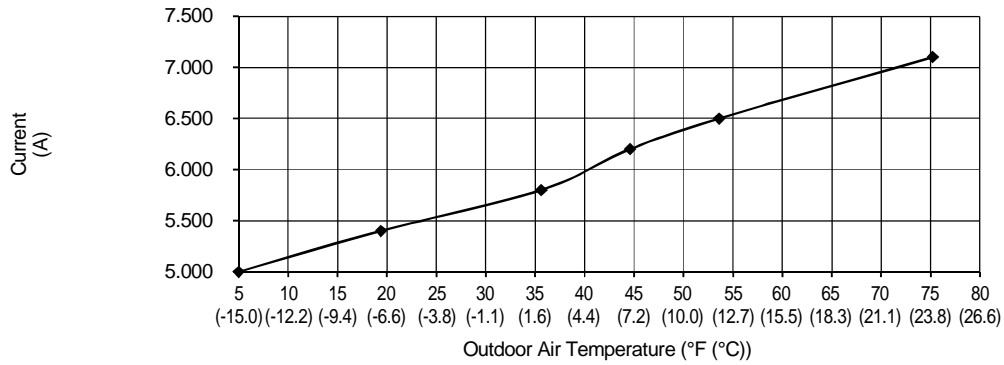
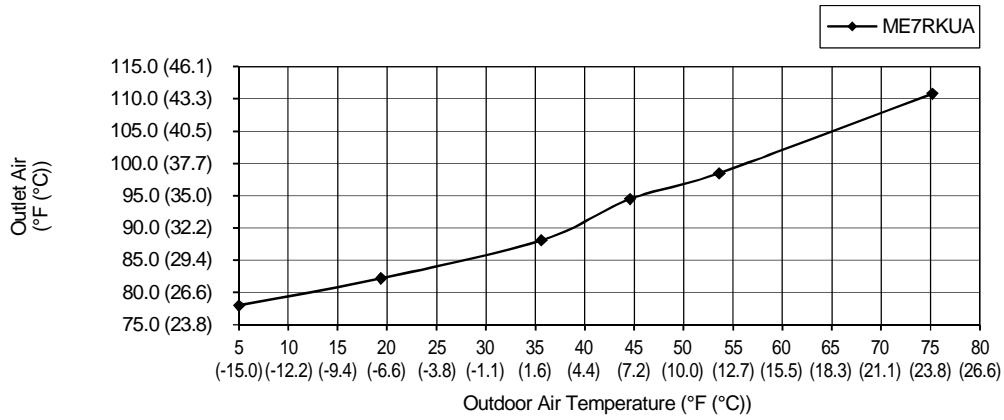

- Heating Characteristic

[Condition] Room temperature: 70.0°F (21.1°C) (DBT), 60.0°F (15.6°C) (WBT)

Operation condition: High fan speed

Piping Length: 7.5m (24.6 ft)

230V 60Hz

B) Indoor unit capacity: Heating (2.5: CS-E9RKUAW), service mode frequency = 39Hz

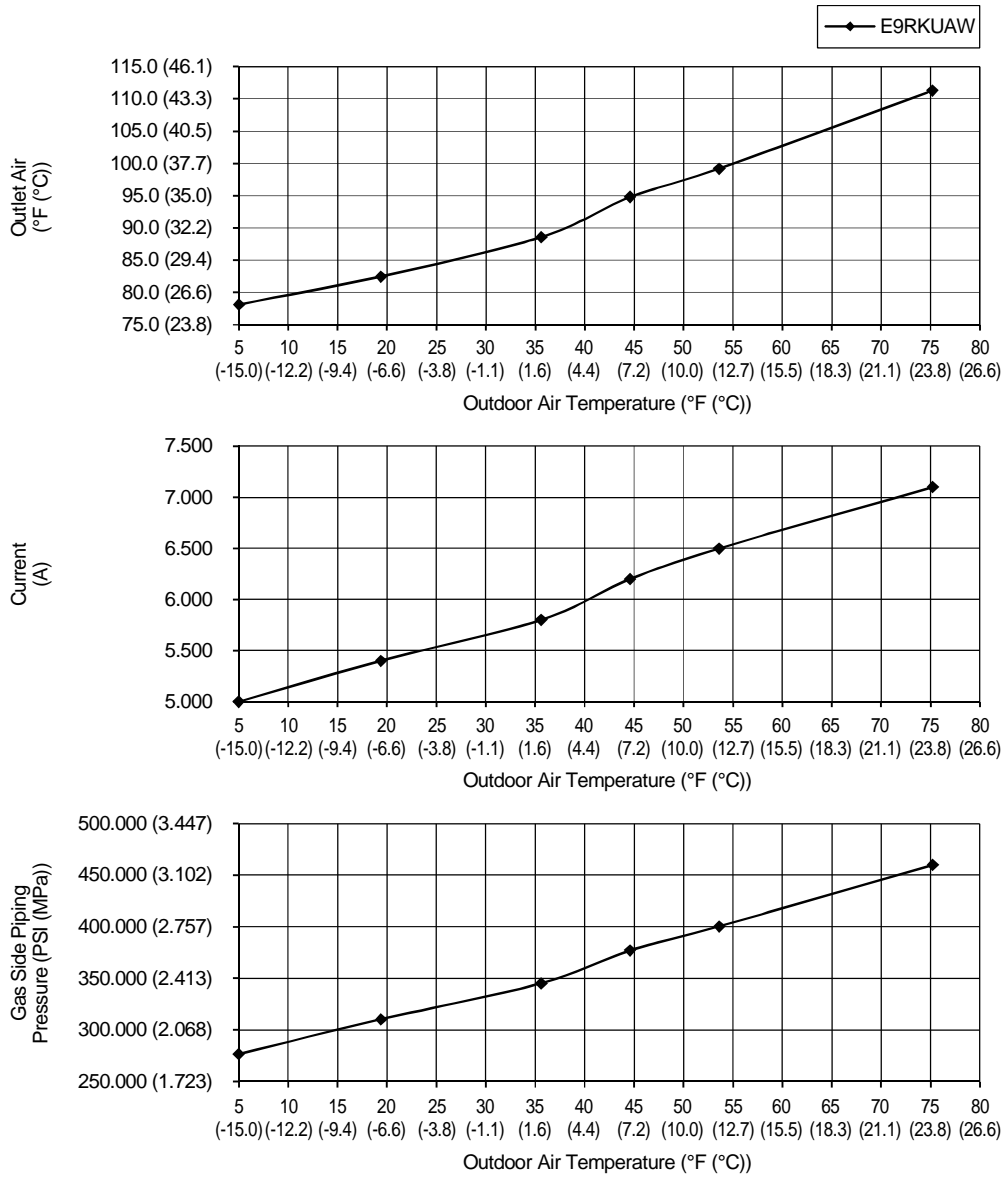

- Heating Characteristic

[Condition] Room temperature: 70.0°F (21.1°C) (DBT), 60.0°F (15.6°C) (WBT)

Operation condition: High fan speed

Piping Length: 7.5m (24.6 ft)

230V 60Hz

C) Indoor unit capacity: Heating (3.2: CS-E12RKUAW), service mode frequency = 47Hz

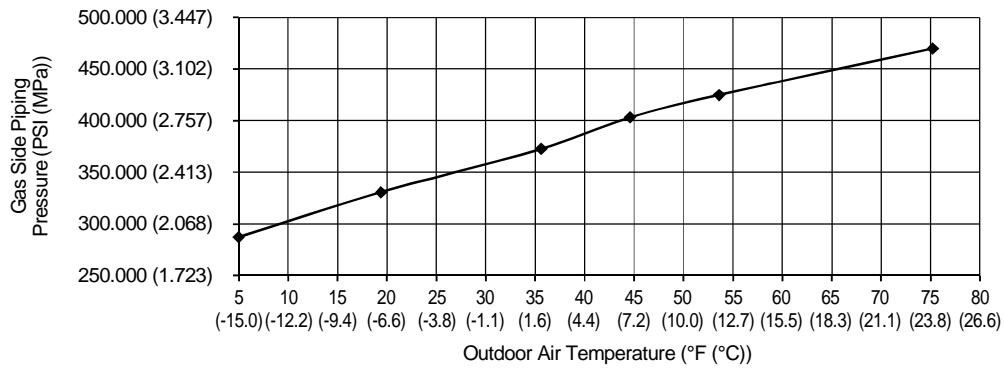
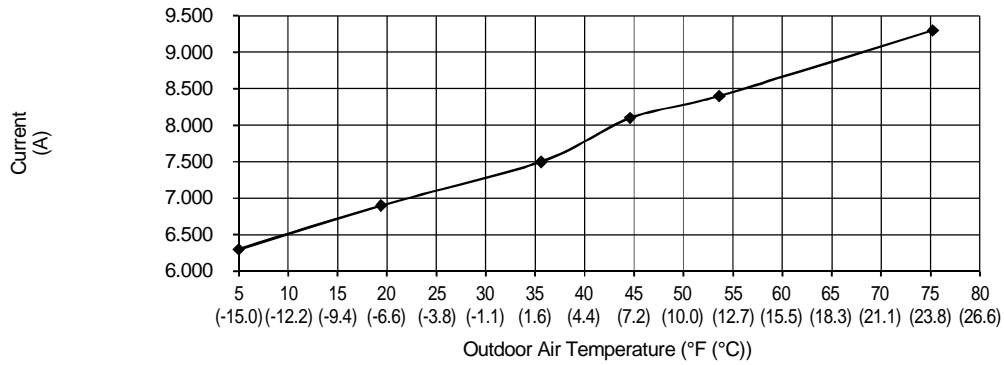
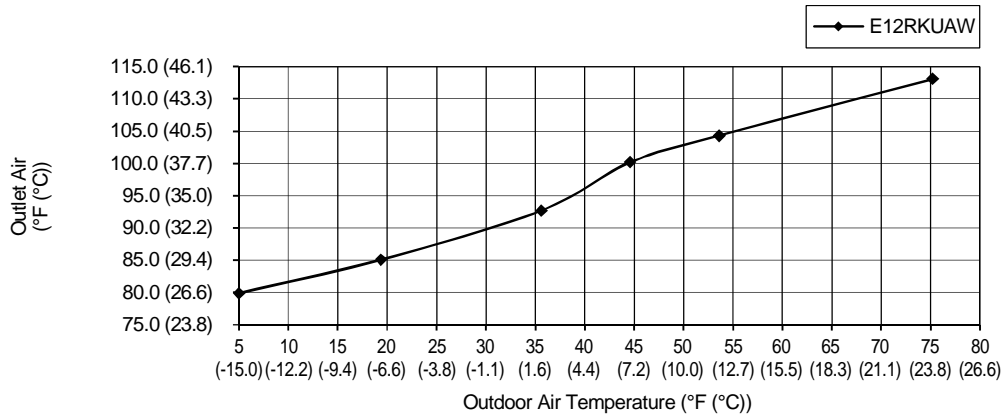

- Heating Characteristic

[Condition] Room temperature: 70.0°F (21.1°C) (DBT), 60.0°F (15.6°C) (WBT)

Operation condition: High fan speed

Piping Length: 7.5m (24.6 ft)

230V 60Hz

D) Indoor unit capacity: Heating (5.0: CS-E18RKUAW), service mode frequency = 55Hz

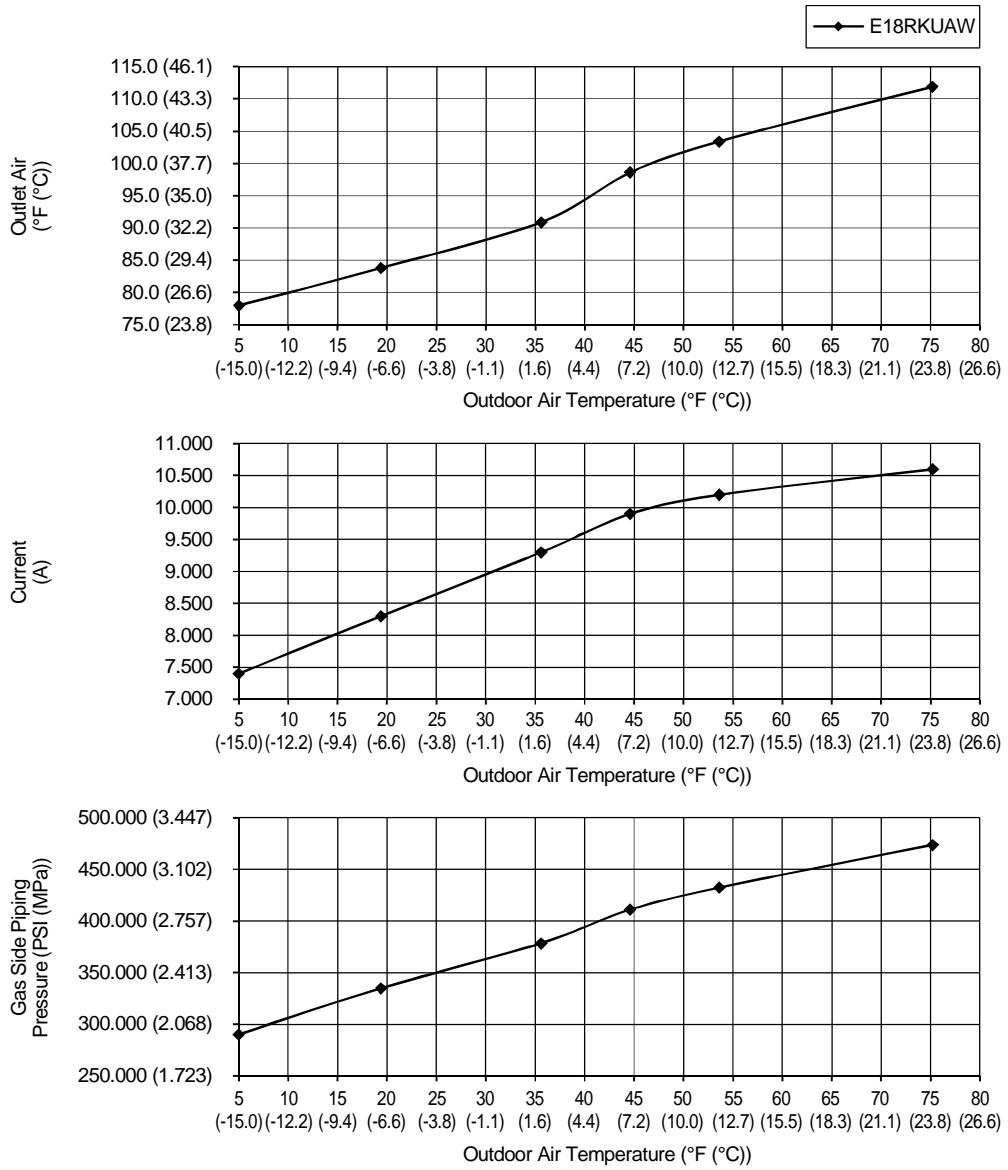

17.2.1.2 Two Indoor Unit Operation

- Cooling Characteristic

[Condition] Room temperature: 80.0°F (26.7°C) (DBT), 67.0°F (19.4°C) (WBT)

Operation condition: High fan speed

Piping Length: 7.5m (24.6 ft)

230V 60Hz

A) Indoor unit capacity: Cooling (2.0 + 2.5: CS-ME7RKUA + CS-E9RKUAW), service mode frequency = 49Hz

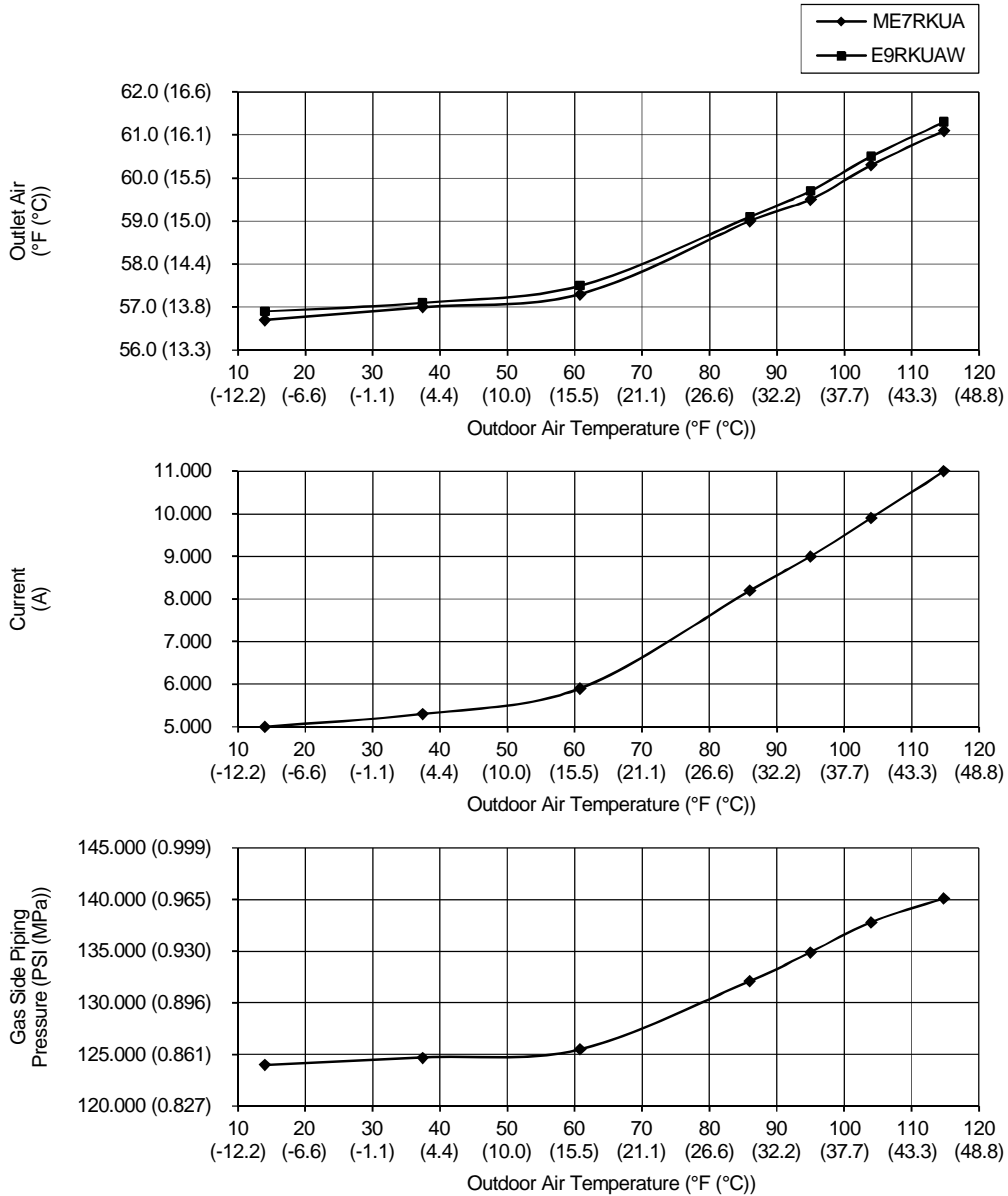

- Cooling Characteristic

[Condition] Room temperature: 80.0°F (26.7°C) (DBT), 67.0°F (19.4°C) (WBT)

Operation condition: High fan speed

Piping Length: 7.5m (24.6 ft)

230V 60Hz

B) Indoor unit capacity: Cooling (2.0 + 3.2: CS-ME7RKUA + CS-E12RKUAW), service mode frequency = 49Hz

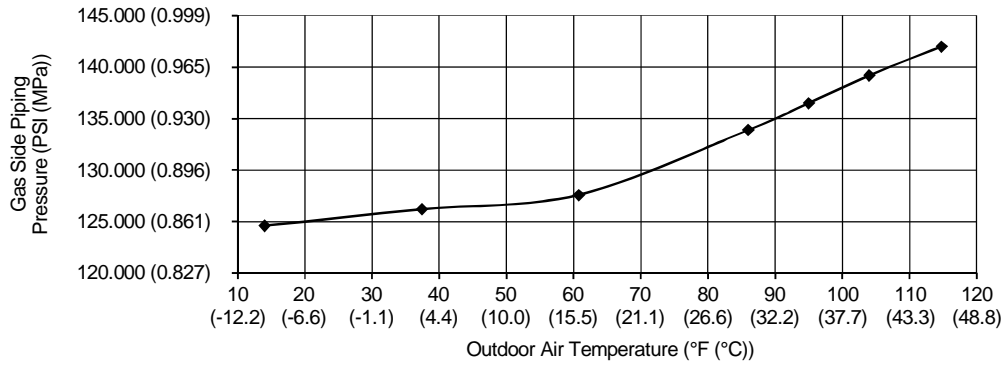
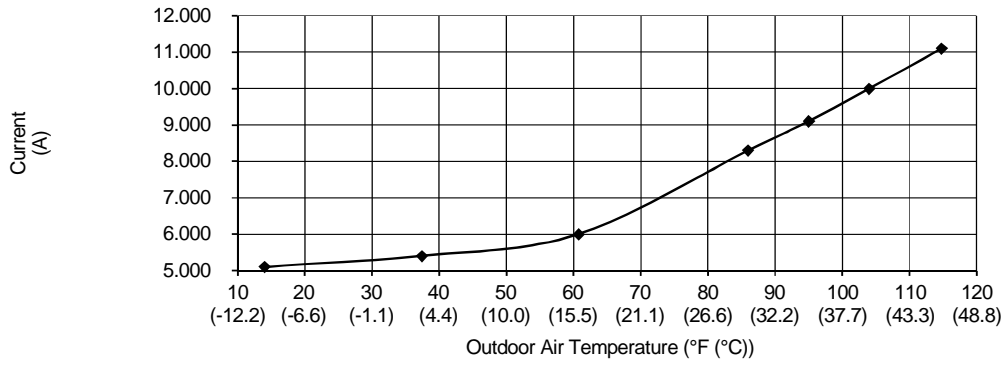
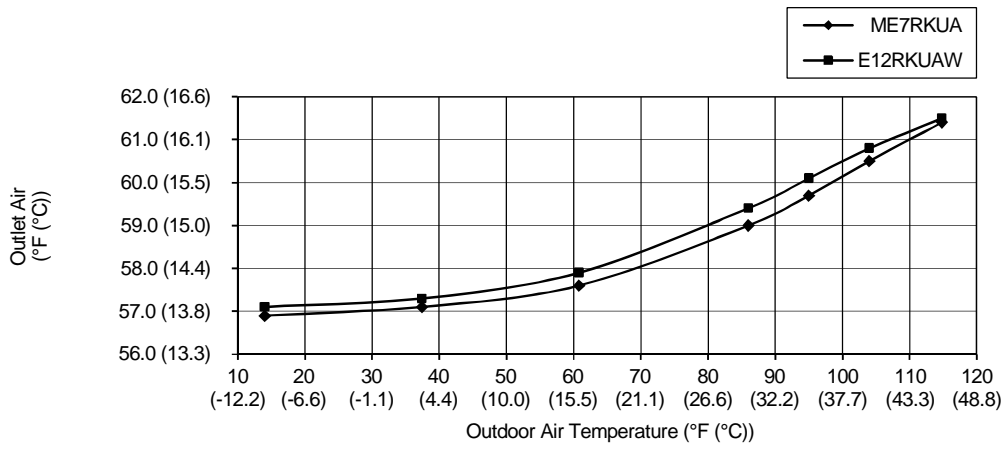

- Cooling Characteristic

[Condition] Room temperature: 80.0°F (26.7°C) (DBT), 67.0°F (19.4°C) (WBT)

Operation condition: High fan speed

Piping Length: 7.5m (24.6 ft)

230V 60Hz

C) Indoor unit capacity: Cooling (2.0 + 5.0: CS-ME7RKUA + CS-E18RKUAW), service mode frequency = 51Hz

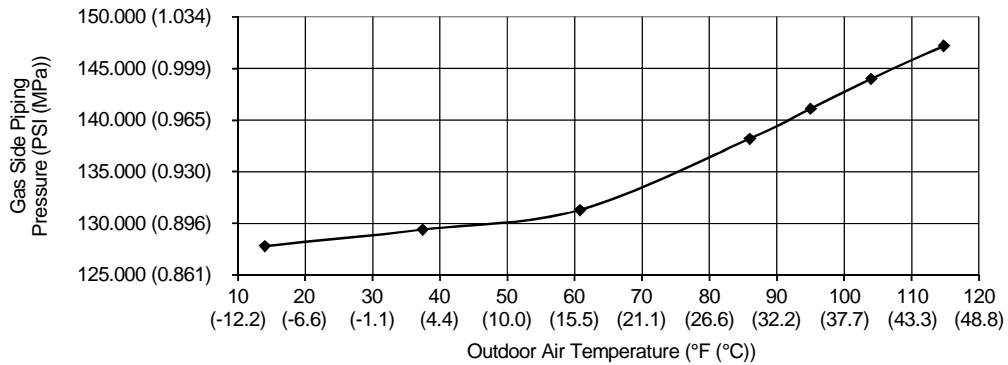
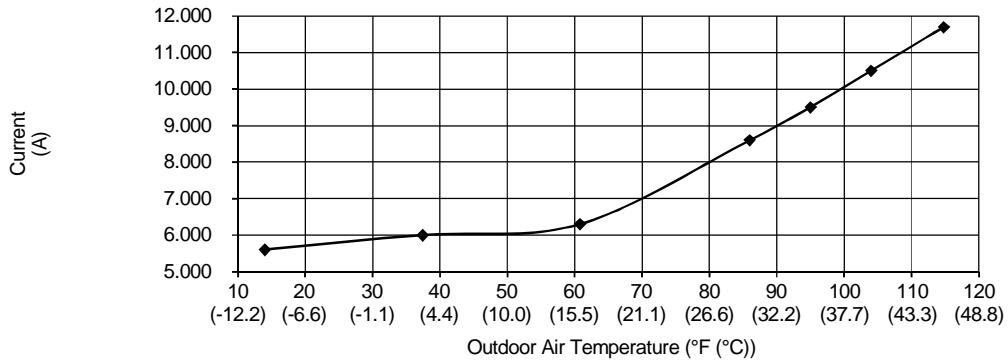
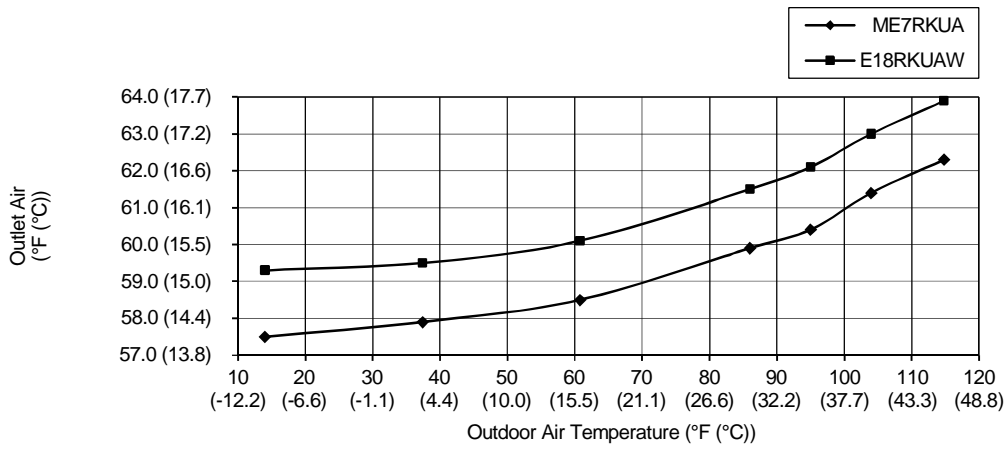

- Cooling Characteristic

[Condition] Room temperature: 80.0°F (26.7°C) (DBT), 67.0°F (19.4°C) (WBT)

Operation condition: High fan speed

Piping Length: 7.5m (24.6 ft)

230V 60Hz

D) Indoor unit capacity: Cooling (2.5 + 3.2: CS-E9RKUAW + CS-E12RKUAW), service mode frequency = 49Hz

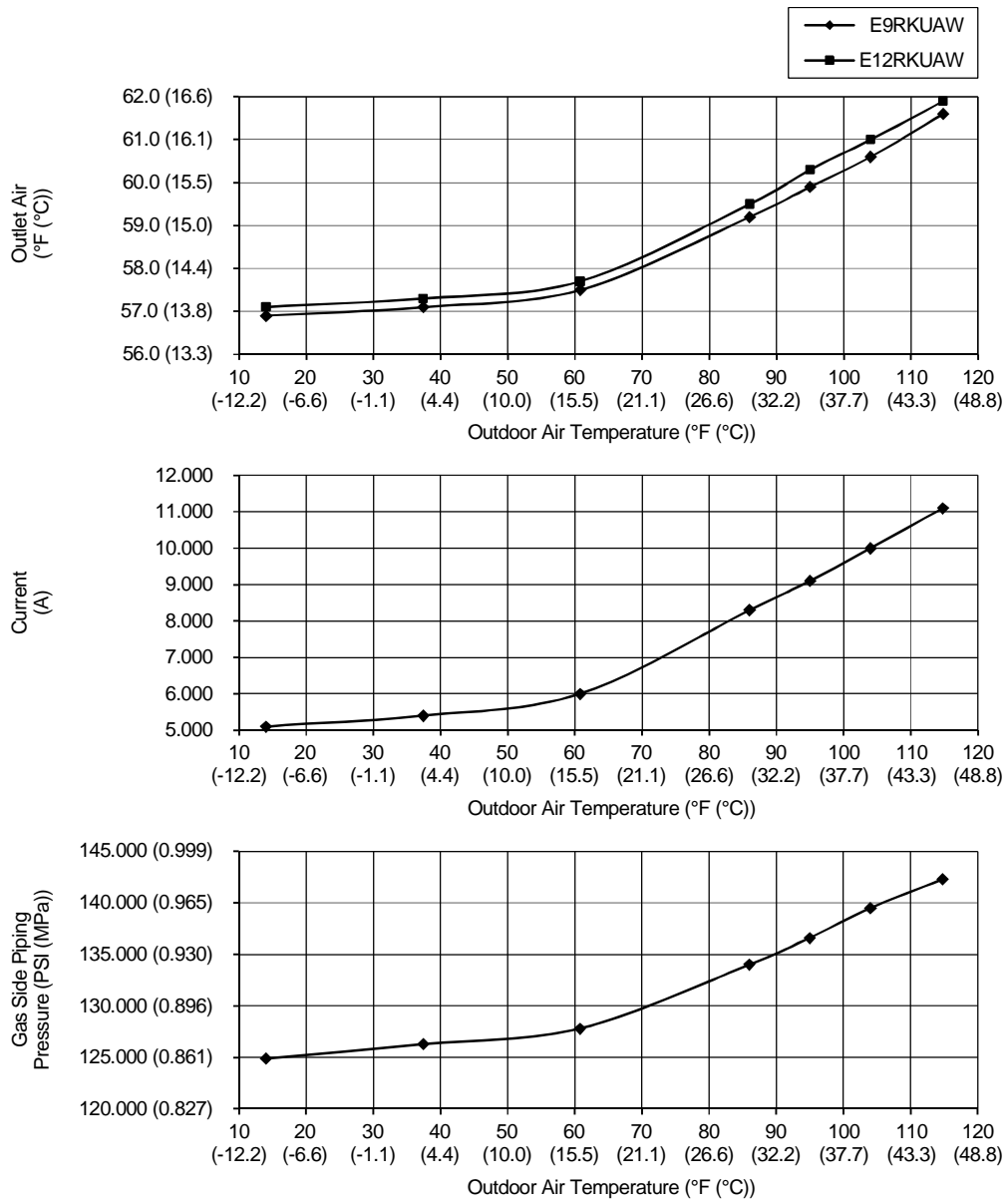

- Cooling Characteristic

[Condition] Room temperature: 80.0°F (26.7°C) (DBT), 67.0°F (19.4°C) (WBT)

Operation condition: High fan speed

Piping Length: 7.5m (24.6 ft)

230V 60Hz

E) Indoor unit capacity: Cooling (2.5 + 5.0: CS-E9RKUAW + CS-E18RKUAW), service mode frequency = 51Hz

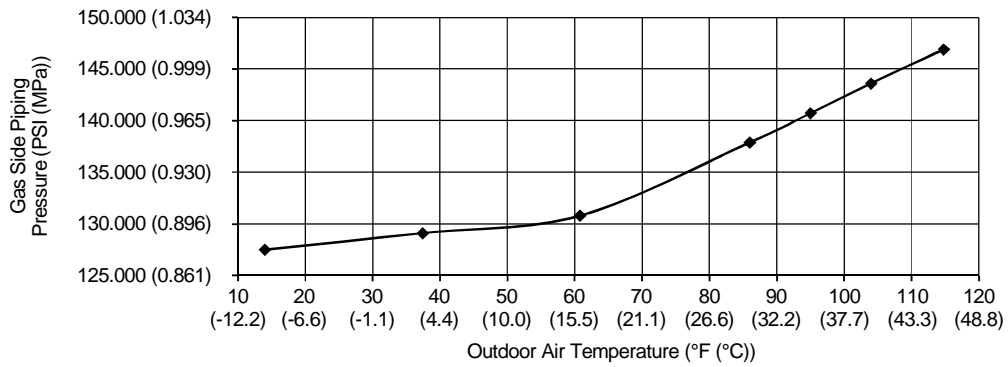
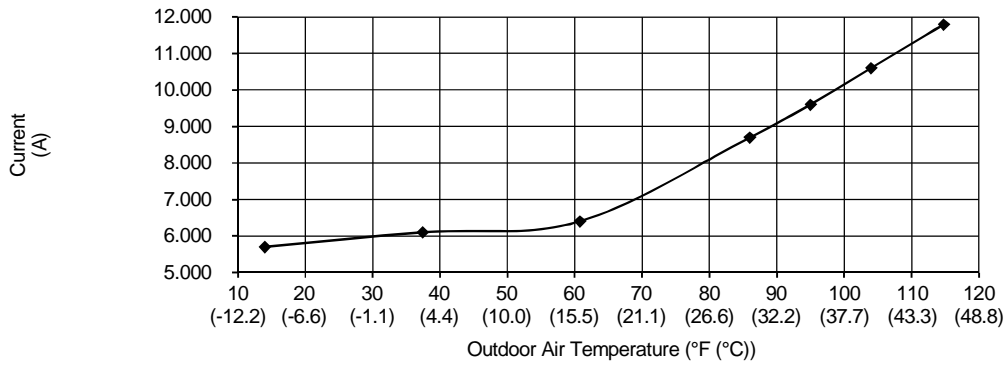
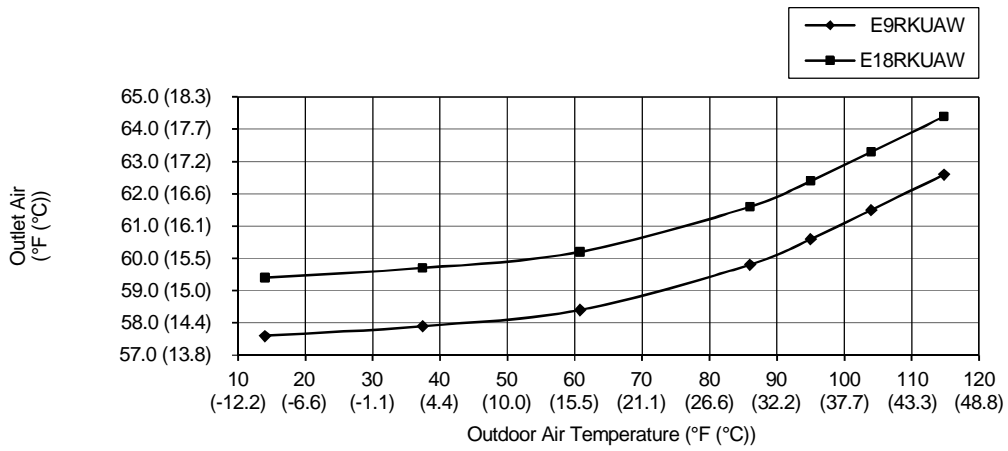

- Cooling Characteristic

[Condition] Room temperature: 80.0°F (26.7°C) (DBT), 67.0°F (19.4°C) (WBT)

Operation condition: High fan speed

Piping Length: 7.5m (24.6 ft)

230V 60Hz

F) Indoor unit capacity: Cooling (3.2 + 5.0: CS-E12RKUAW + CS-E18RKUAW), service mode frequency = 53Hz

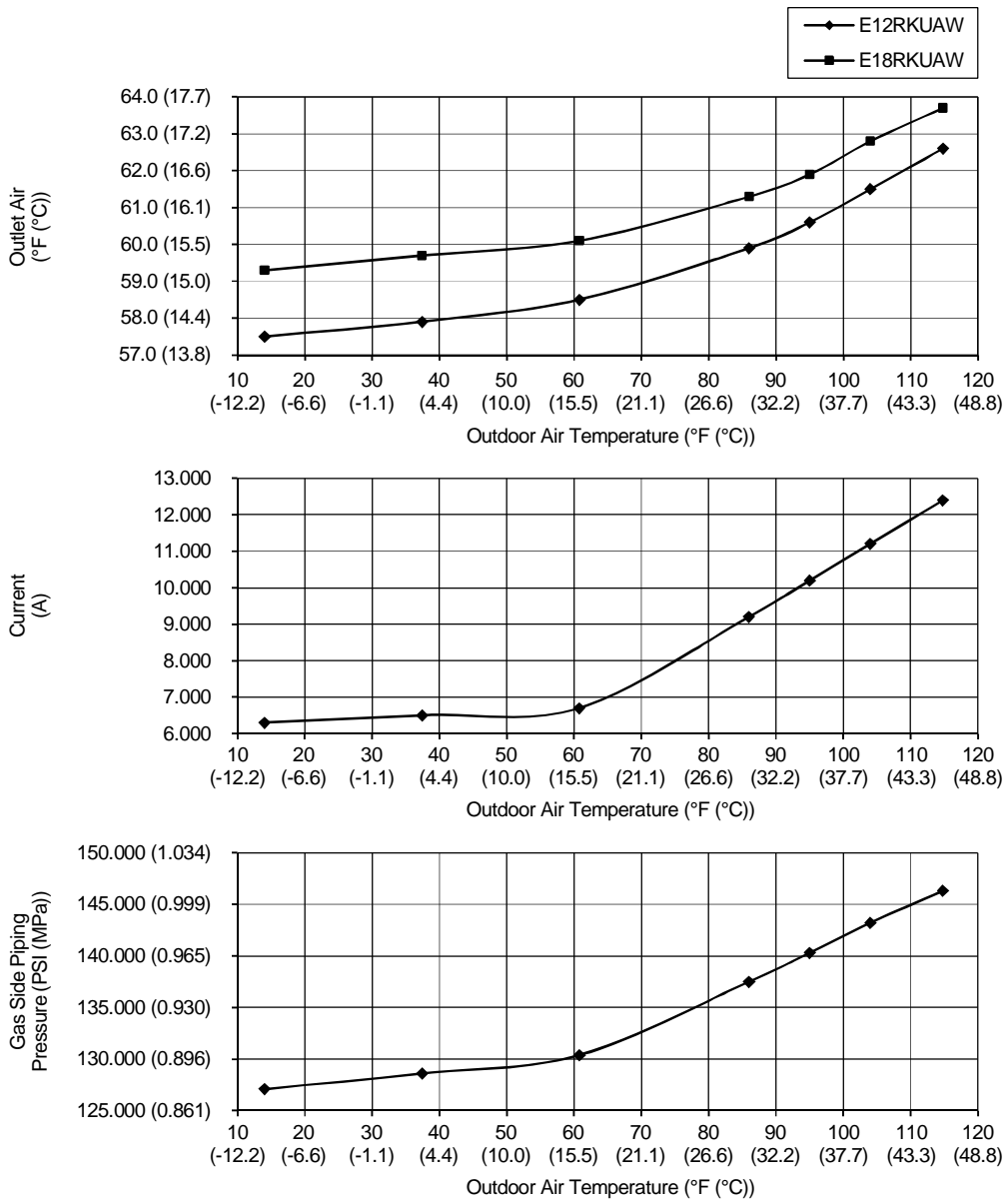

- Heating Characteristic

[Condition] Room temperature: 70.0°F (21.1°C) (DBT), 60.0°F (15.6°C) (WBT)

Operation condition: High fan speed

Piping Length: 7.5m (24.6 ft)

230V 60Hz

A) Indoor unit capacity: Heating (2.0 + 2.5: CS-ME7RKUA + CS-E9RKUAW), service mode frequency = 58Hz

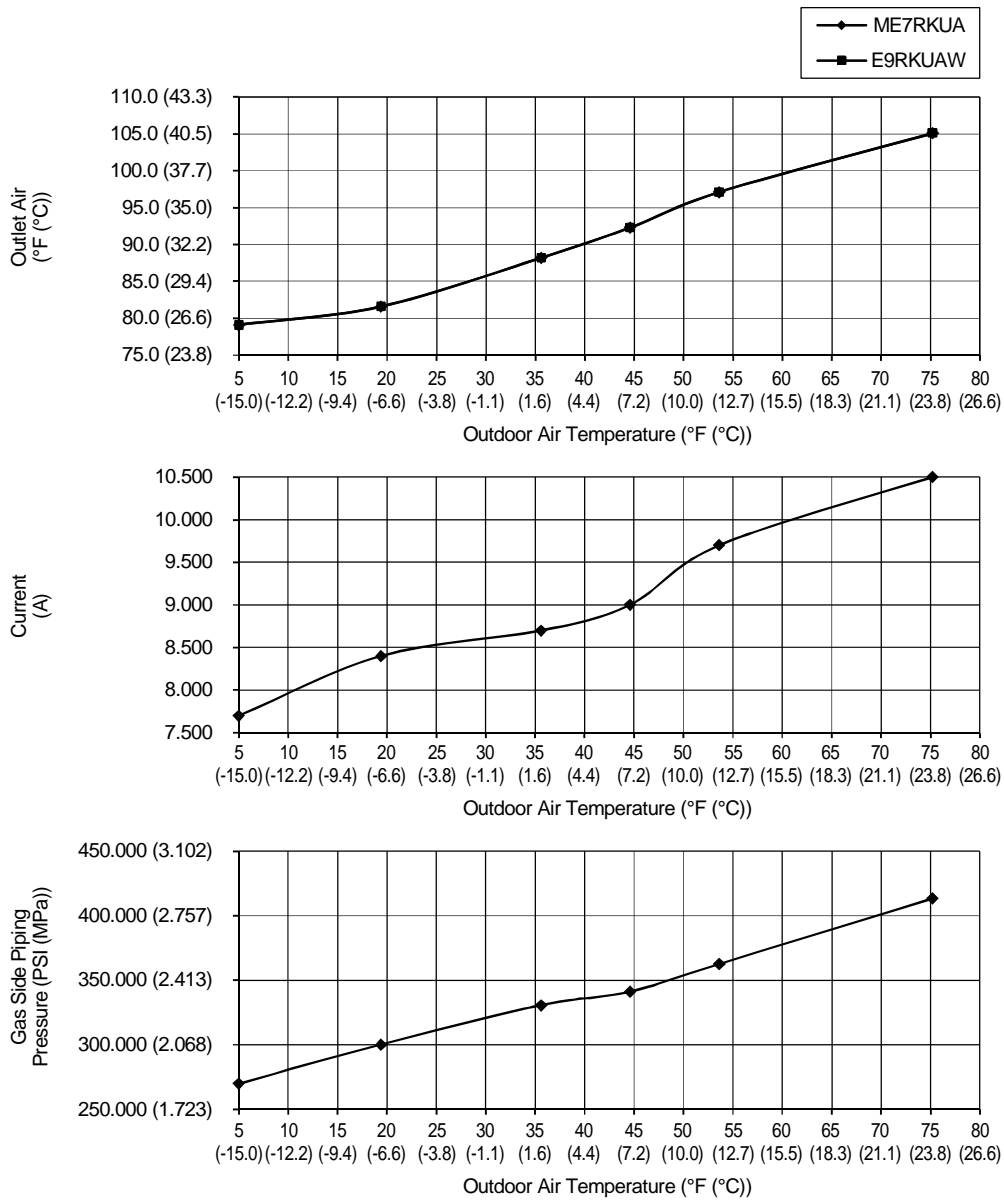

- Heating Characteristic

[Condition] Room temperature: 70.0°F (21.1°C) (DBT), 60.0°F (15.6°C) (WBT)

Operation condition: High fan speed

Piping Length: 7.5m (24.6 ft)

230V 60Hz

B) Indoor unit capacity: Heating (2.0 + 3.2: CS-ME7RKUA + CS-E12RKUAW), service mode frequency = 64Hz

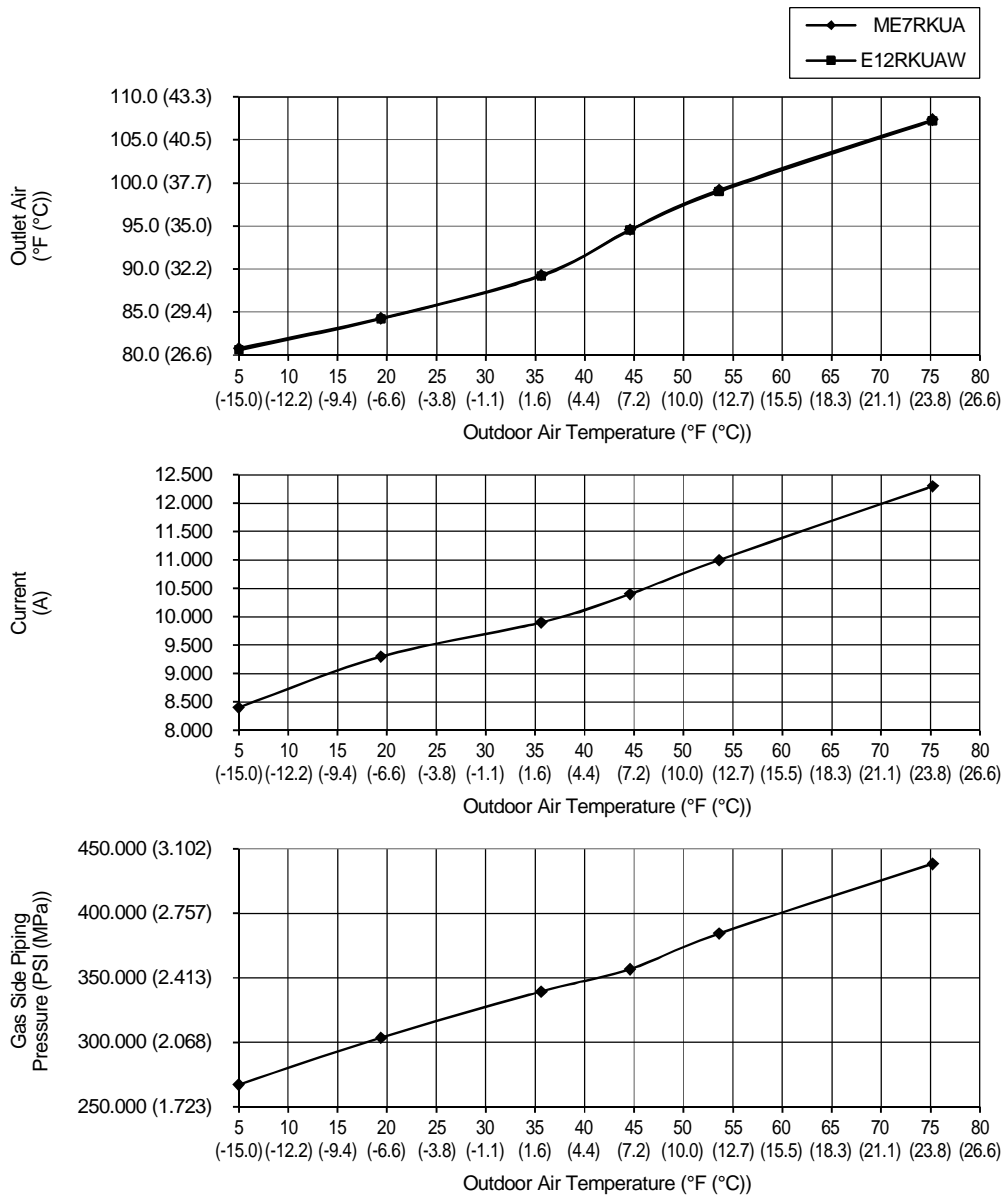

- Heating Characteristic

[Condition] Room temperature: 70.0°F (21.1°C) (DBT), 60.0°F (15.6°C) (WBT)

Operation condition: High fan speed

Piping Length: 7.5m (24.6 ft)

230V 60Hz

C) Indoor unit capacity: Heating (2.0 + 5.0: CS-ME7RKUA + CS-E18RKUAW), service mode frequency = 68Hz

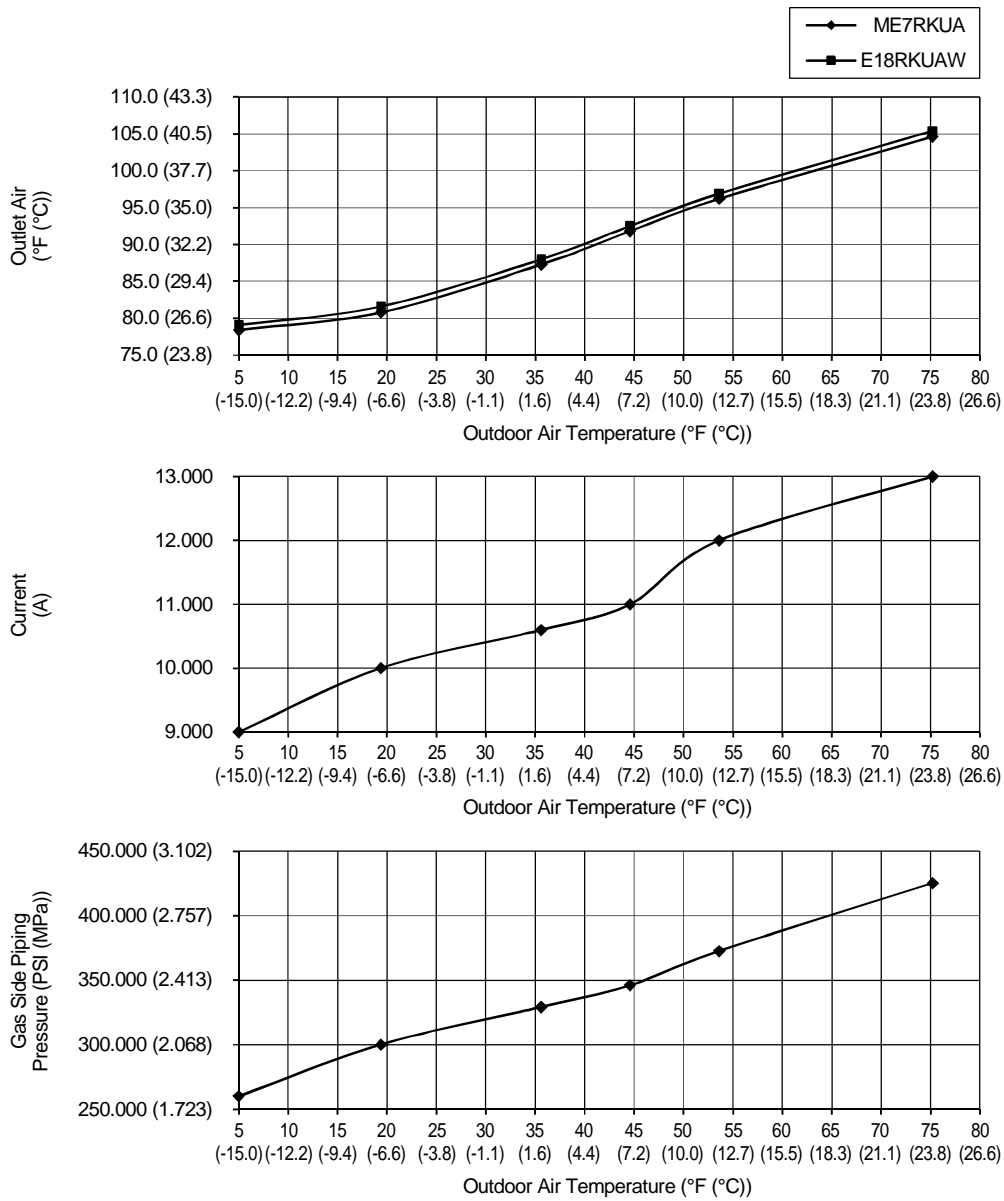

- Heating Characteristic

[Condition] Room temperature: 70.0°F (21.1°C) (DBT), 60.0°F (15.6°C) (WBT)

Operation condition: High fan speed

Piping Length: 7.5m (24.6 ft)

230V 60Hz

D) Indoor unit capacity: Heating (2.5 + 3.2: CS-E9RKUAW + CS-E12RKUAW), service mode frequency = 64Hz

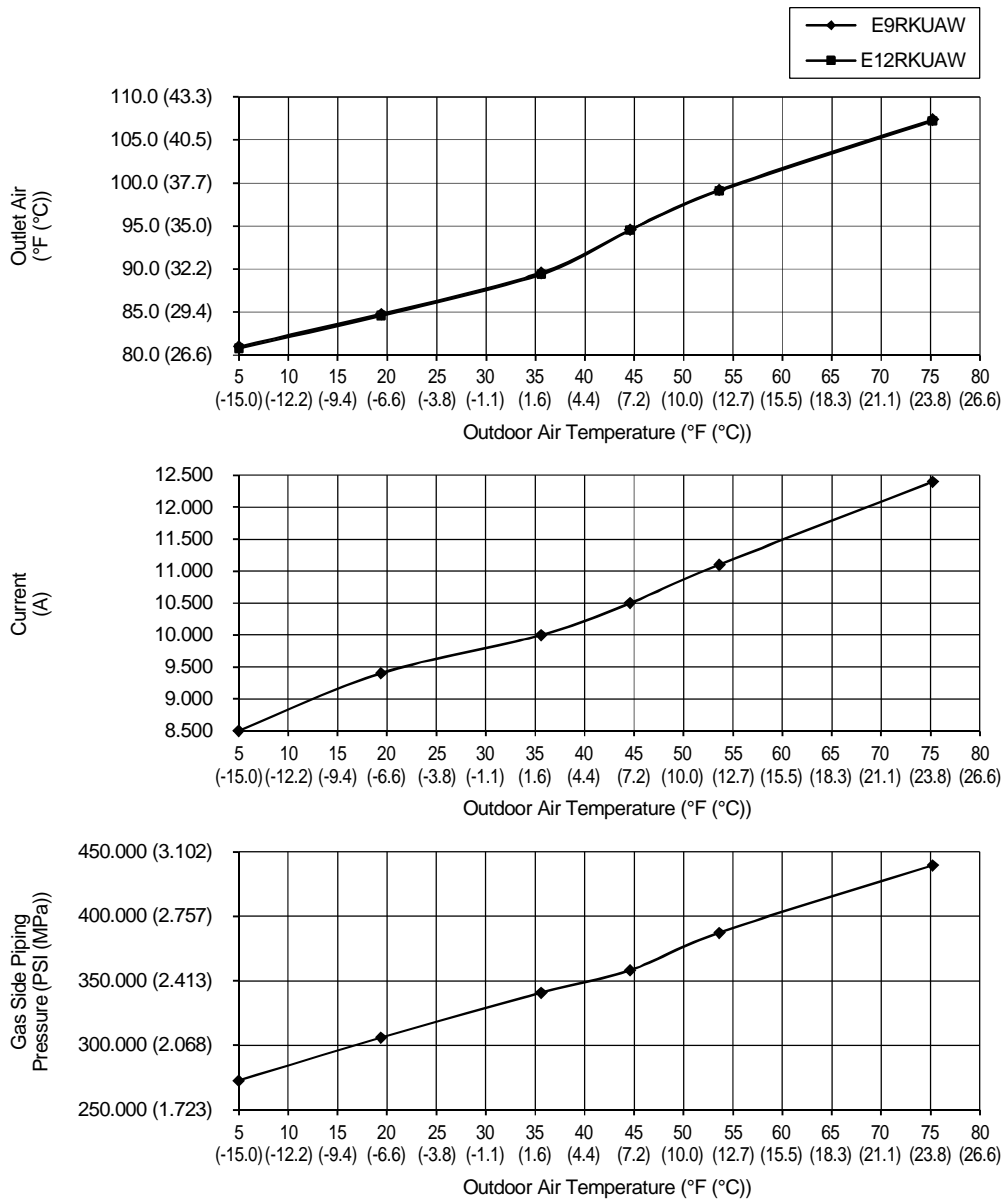

- Heating Characteristic

[Condition] Room temperature: 70.0°F (21.1°C) (DBT), 60.0°F (15.6°C) (WBT)

Operation condition: High fan speed

Piping Length: 7.5m (24.6 ft)

230V 60Hz

E) Indoor unit capacity: Heating (2.5 + 5.0: CS-E9RKUAW + CS-E18RKUAW), service mode frequency = 68Hz

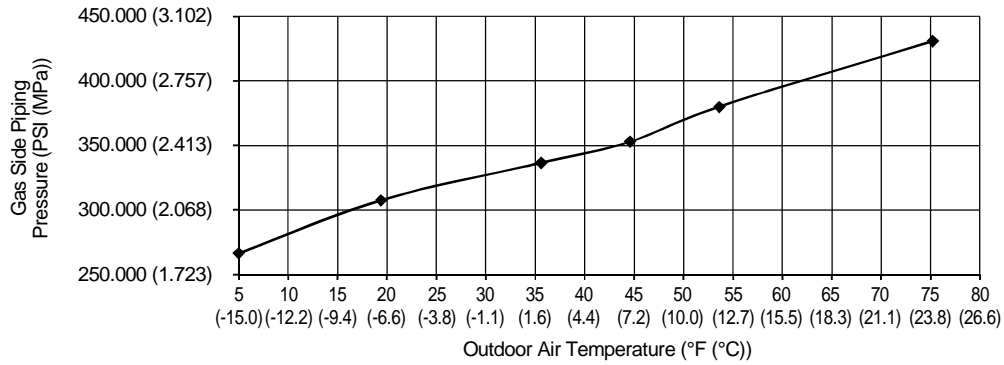
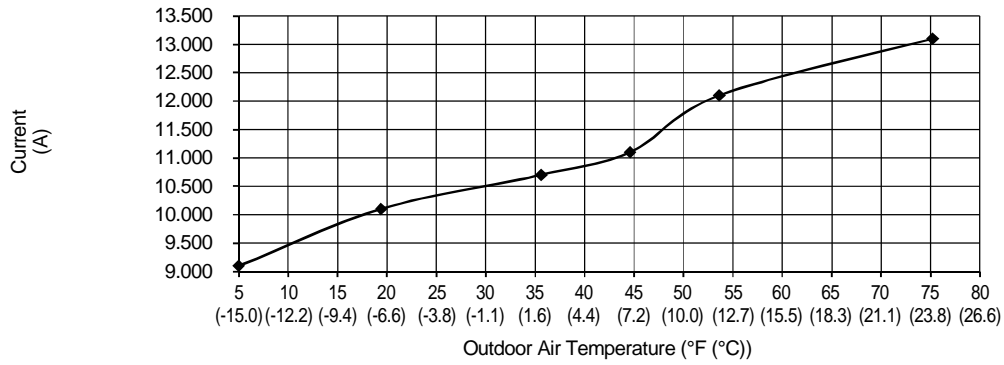
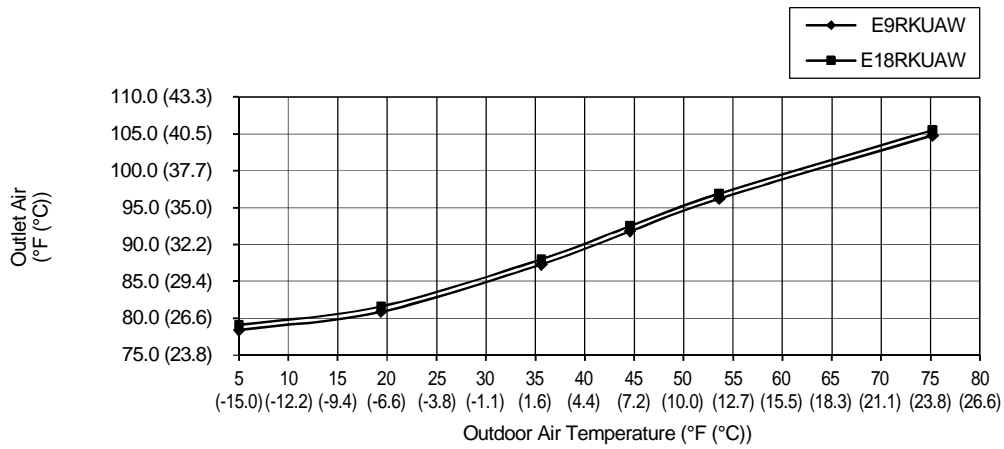

- Heating Characteristic

[Condition] Room temperature: 70.0°F (21.1°C) (DBT), 60.0°F (15.6°C) (WBT)

Operation condition: High fan speed

Piping Length: 7.5m (24.6 ft)

230V 60Hz

F) Indoor unit capacity: Heating (3.2 + 5.0: CS-E12RKUAW + CS-E18RKUAW), service mode frequency = 73Hz

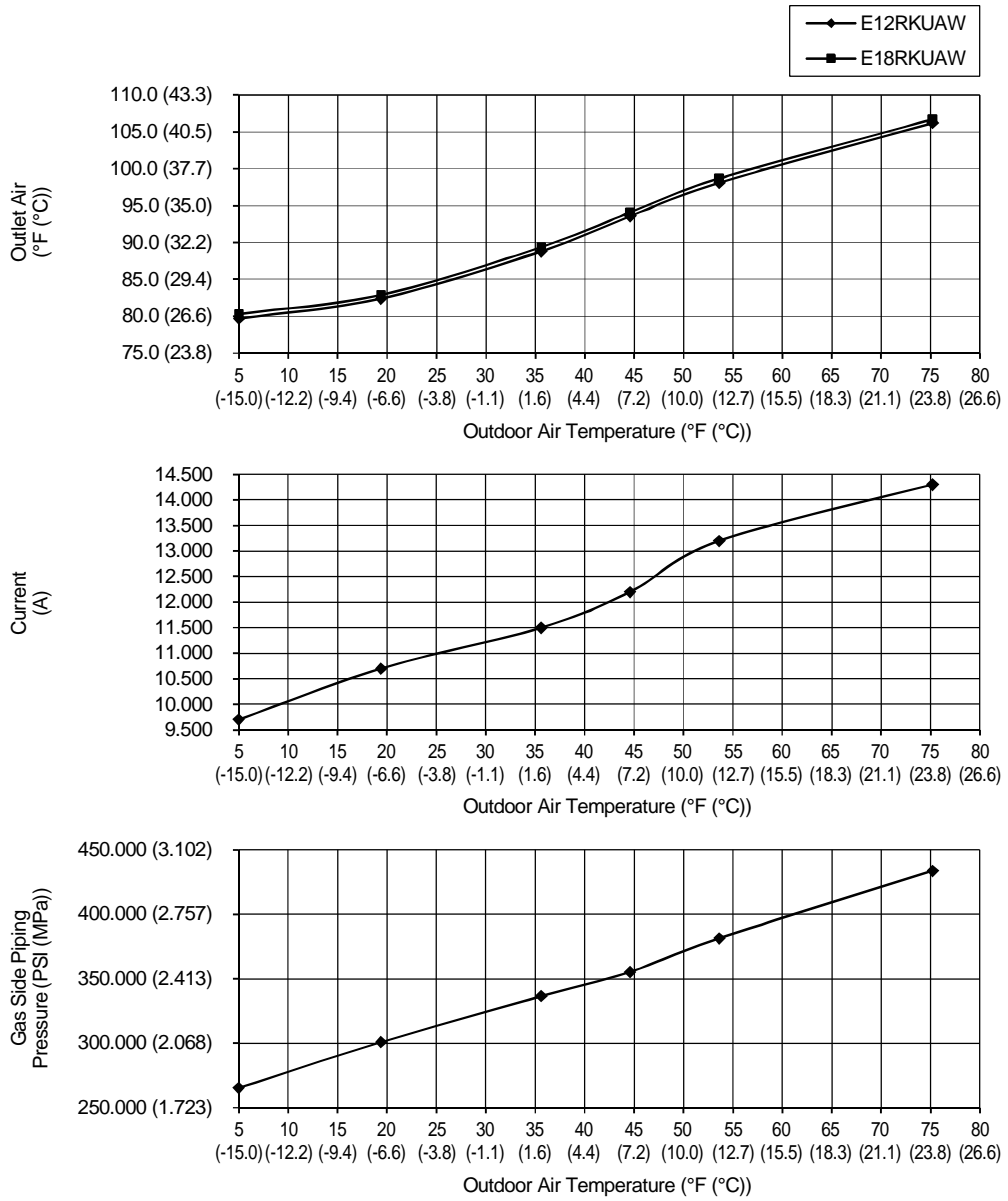

17.2.1.3 Three Indoor Unit Operation

- Cooling Characteristic

[Condition] Room temperature: 80.0°F (26.7°C) (DBT), 67.0°F (19.4°C) (WBT)

Operation condition: High fan speed

Piping Length: 7.5m (24.6 ft)

230V 60Hz

A) Indoor unit capacity: Cooling (2.0 + 2.5 + 3.2: CS-ME7RKUA + CS-E9RKUAW + CS-E12RKUAW), service mode frequency = 55Hz

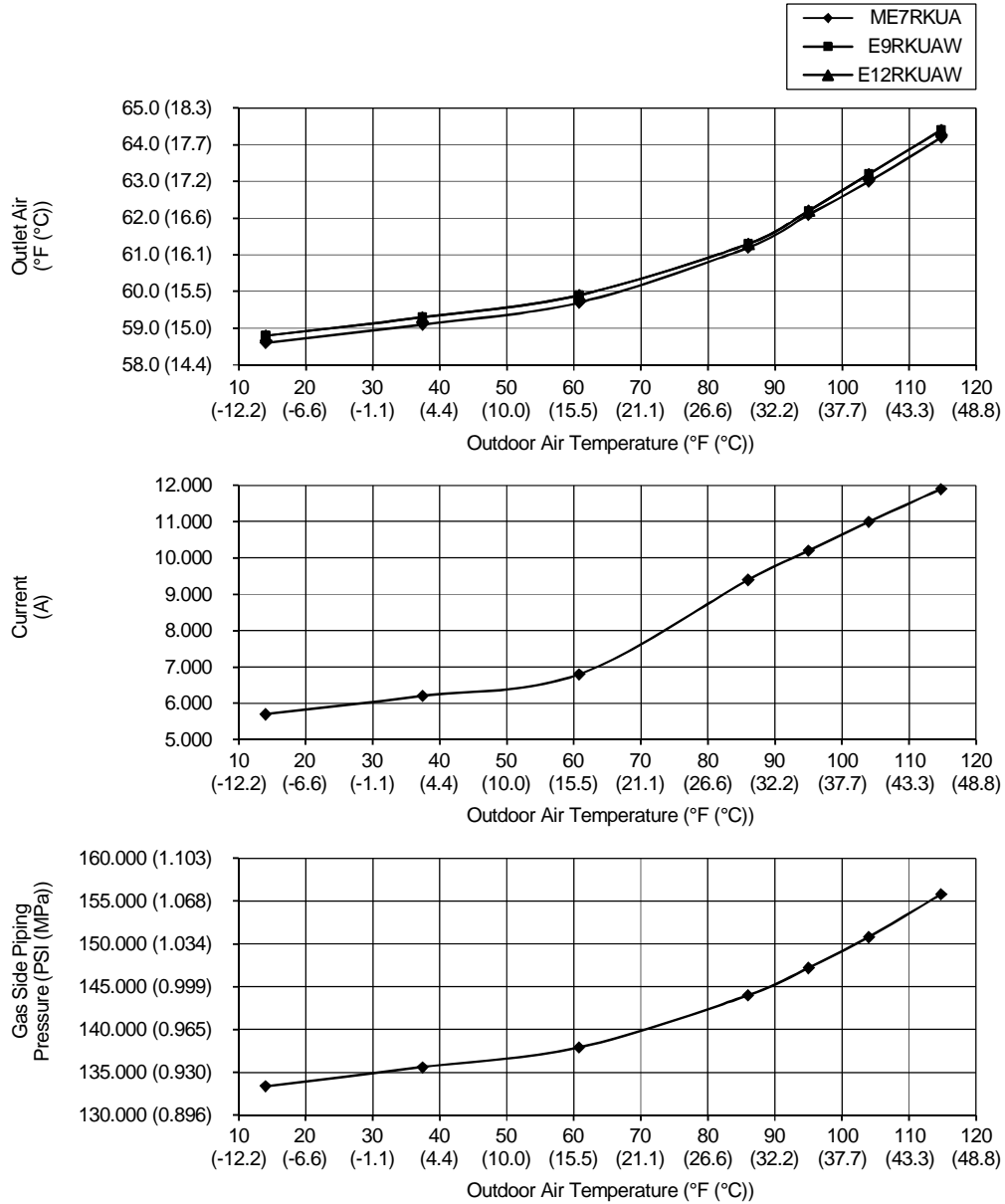

- Cooling Characteristic

[Condition] Room temperature: 80.0°F (26.7°C) (DBT), 67.0°F (19.4°C) (WBT)

Operation condition: High fan speed

Piping Length: 7.5m (24.6 ft)

230V 60Hz

B) Indoor unit capacity: Cooling (2.0 + 2.5 + 5.0: CS-ME7RKUA + CS-E9RKUAW + CS-E18RKUAW), service mode frequency = 57Hz

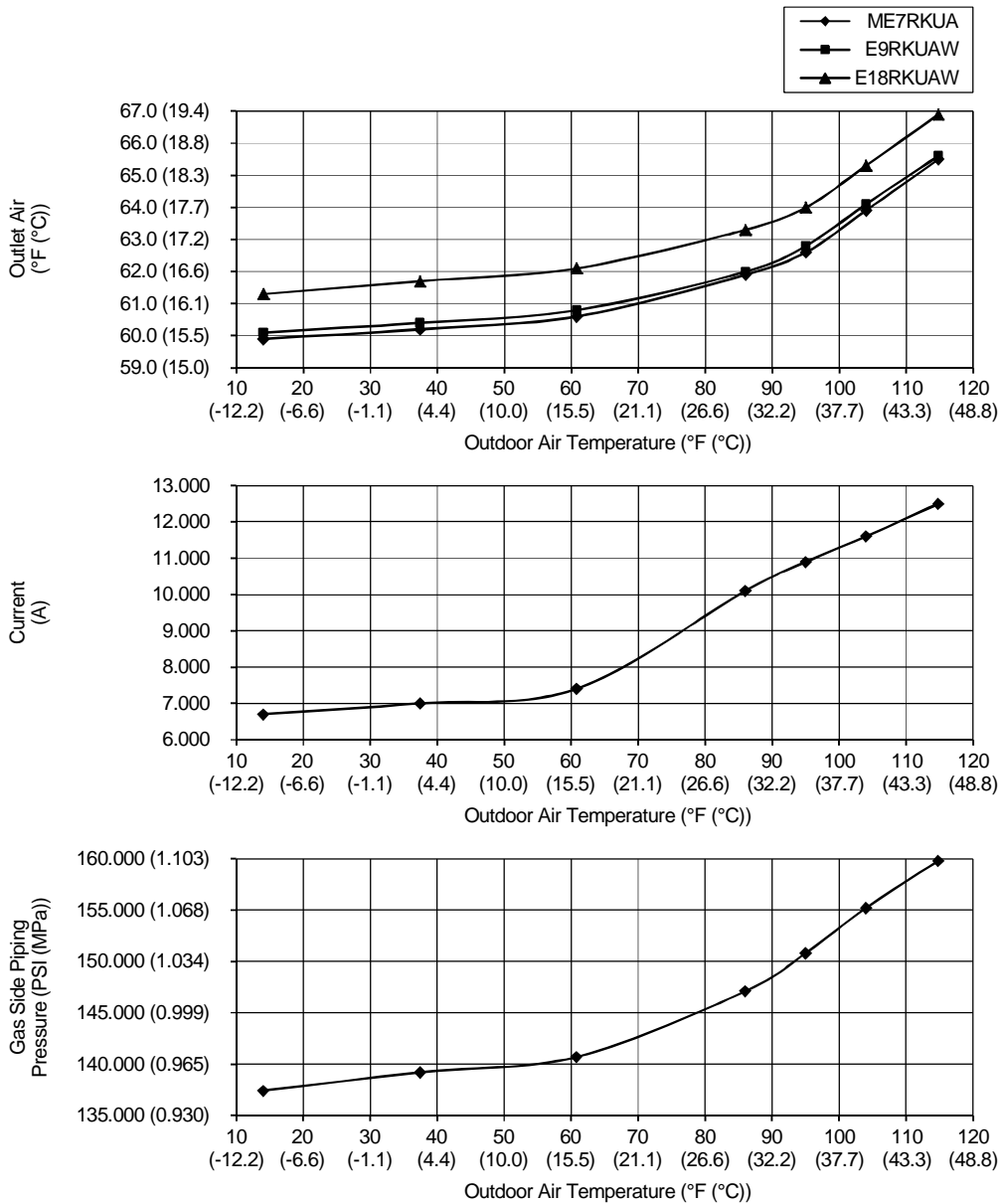

- Cooling Characteristic

[Condition] Room temperature: 80.0°F (26.7°C) (DBT), 67.0°F (19.4°C) (WBT)

Operation condition: High fan speed

Piping Length: 7.5m (24.6 ft)

230V 60Hz

C) Indoor unit capacity: Cooling (2.0 + 3.2 + 5.0: CS-ME7RKUA + CS-E12RKUAW + CS-E18RKUAW), service mode frequency = 59Hz

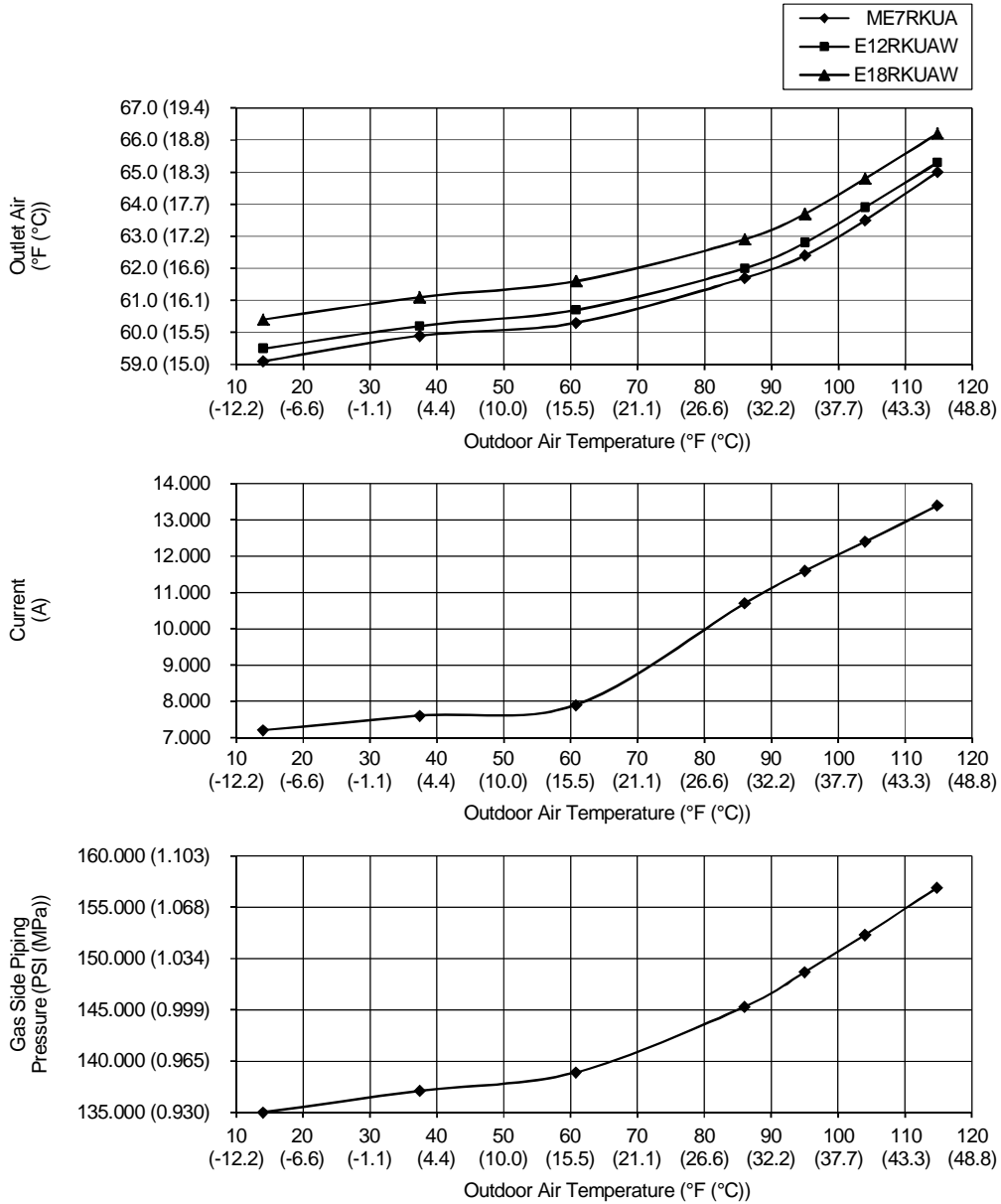

- Cooling Characteristic

[Condition] Room temperature: 80.0°F (26.7°C) (DBT), 67.0°F (19.4°C) (WBT)

Operation condition: High fan speed

Piping Length: 7.5m (24.6 ft)

230V 60Hz

D) Indoor unit capacity: Cooling (2.5 + 3.2 + 5.0: CS-E9RKUAW + CS-E12RKUAW + CS-E18RKUAW), service mode frequency = 59Hz

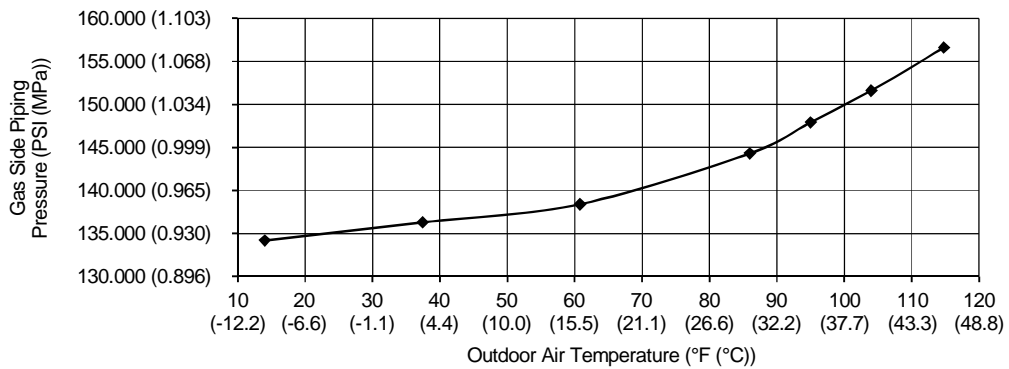
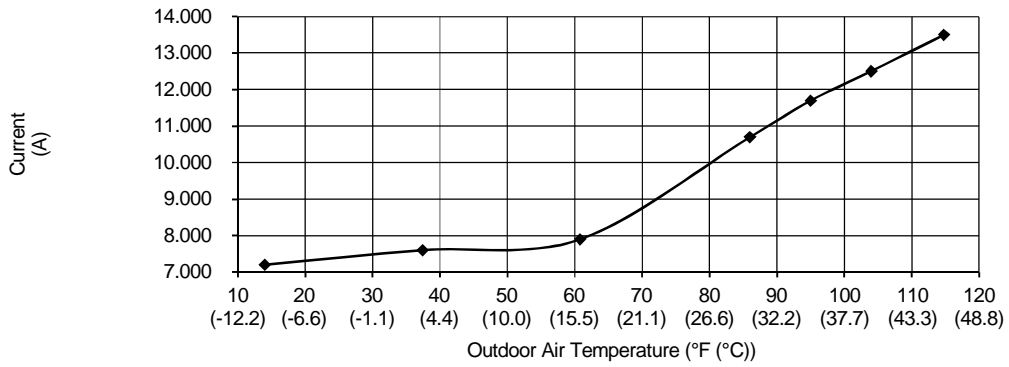
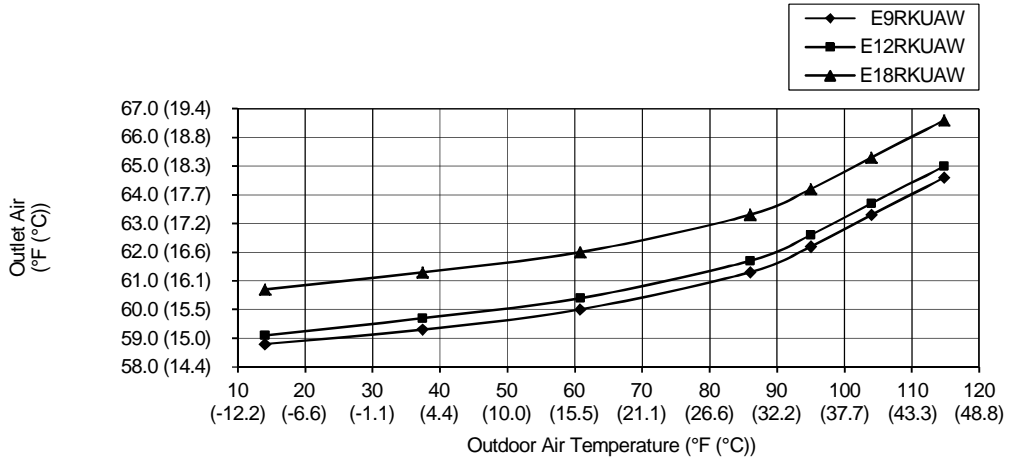

- Heating Characteristic

[Condition] Room temperature: 70.0°F (21.1°C) (DBT), 60.0°F (15.6°C) (WBT)

Operation condition: High fan speed

Piping Length: 7.5m (24.6 ft)

230V 60Hz

A) Indoor unit capacity: Heating (2.0 + 2.5 + 3.2: CS-ME7RKUA + CS-E9RKUAW + CS-E12RKUAW), service mode frequency = 77Hz

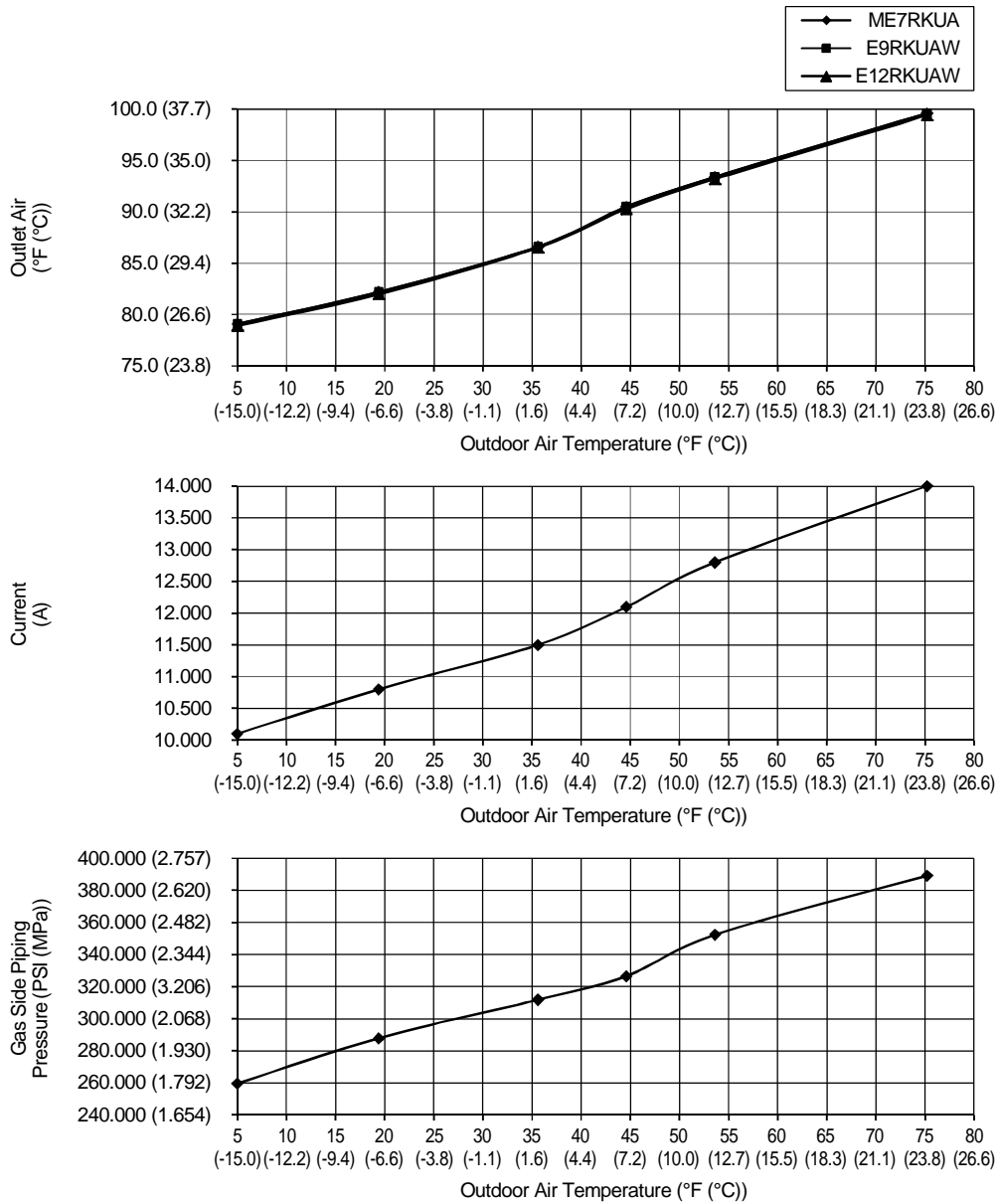

- Heating Characteristic

[Condition] Room temperature: 70.0°F (21.1°C) (DBT), 60.0°F (15.6°C) (WBT)

Operation condition: High fan speed

Piping Length: 7.5m (24.6 ft)

230V 60Hz

B) Indoor unit capacity: Heating (2.0 + 2.5 + 5.0: CS-ME7RKUA + CS-E9RKUAW + CS-E18RKUAW), service mode frequency = 77Hz

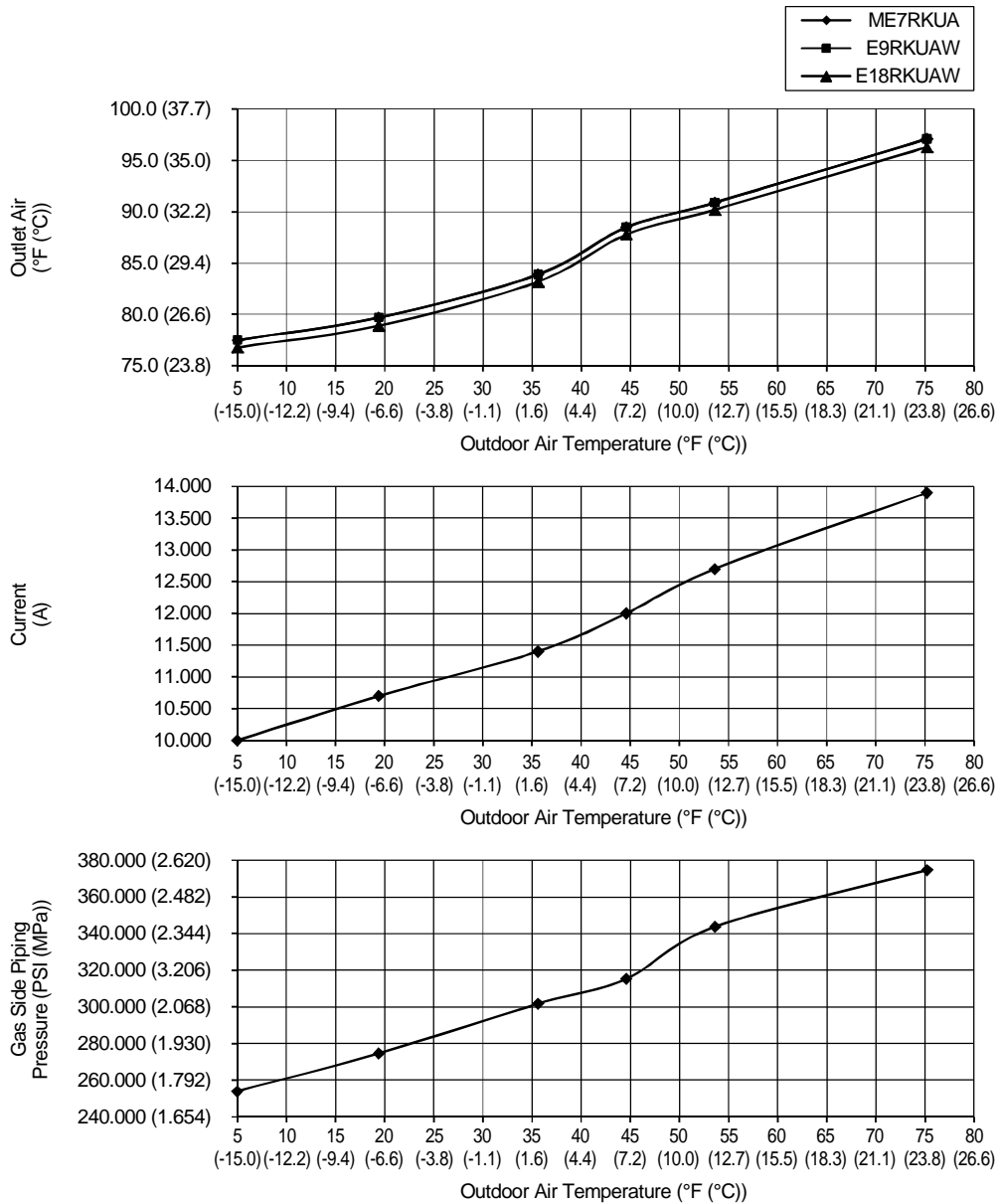

- Heating Characteristic

[Condition] Room temperature: 70.0°F (21.1°C) (DBT), 60.0°F (15.6°C) (WBT)

Operation condition: High fan speed

Piping Length: 7.5m (24.6 ft)

230V 60Hz

C) Indoor unit capacity: Heating (2.0 + 3.2 + 5.0: CS-ME7RKUA + CS-E12RKUAW + CS-E18RKUAW), service mode frequency = 82Hz

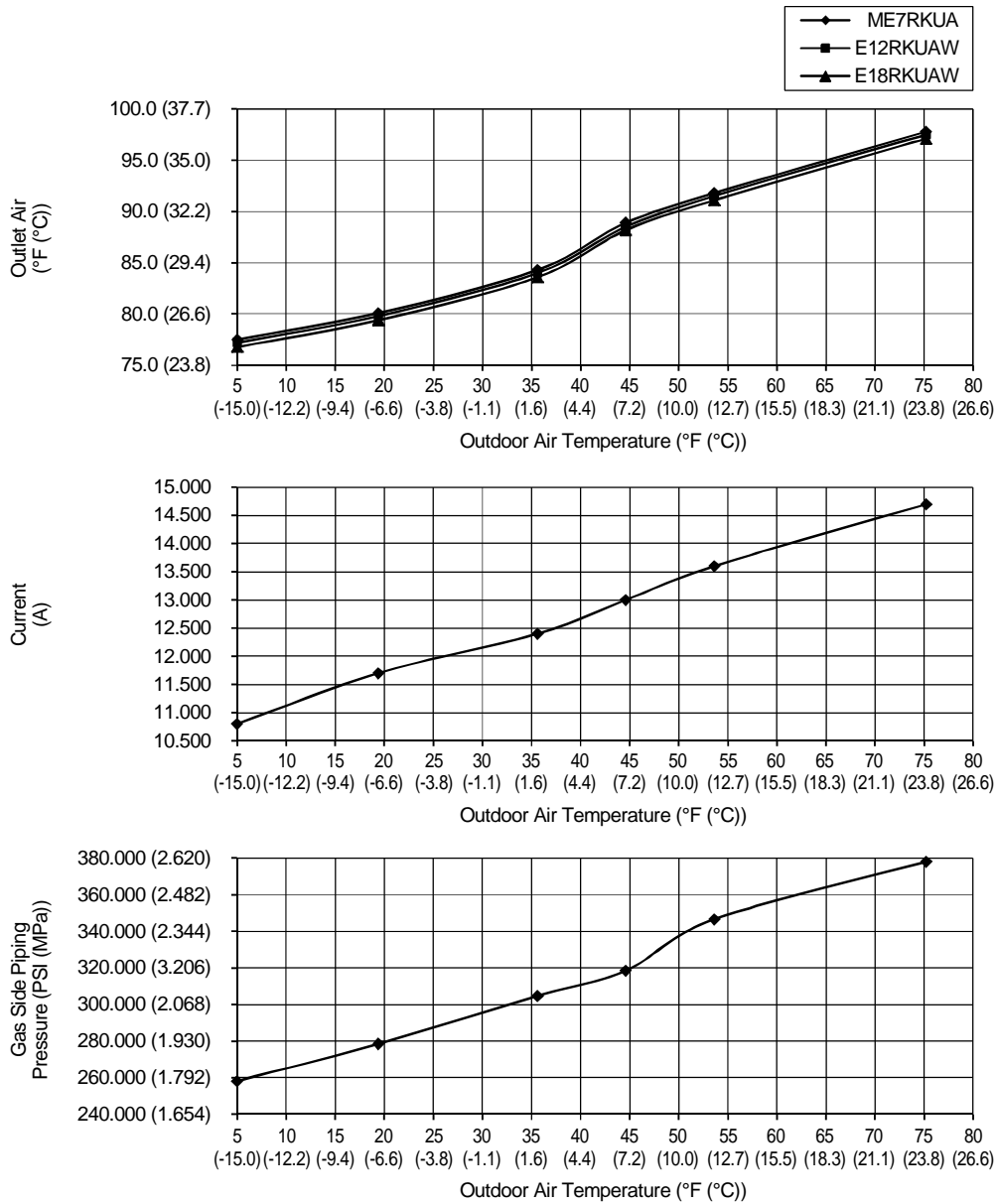

- Heating Characteristic

[Condition] Room temperature: 70.0°F (21.1°C) (DBT), 60.0°F (15.6°C) (WBT)

Operation condition: High fan speed

Piping Length: 7.5m (24.6 ft)

230V 60Hz

D) Indoor unit capacity: Heating (2.5 + 3.2 + 5.0: CS-E9RKUAW + CS-E12RKUAW + CS-E18RKUAW), service mode frequency = 82Hz

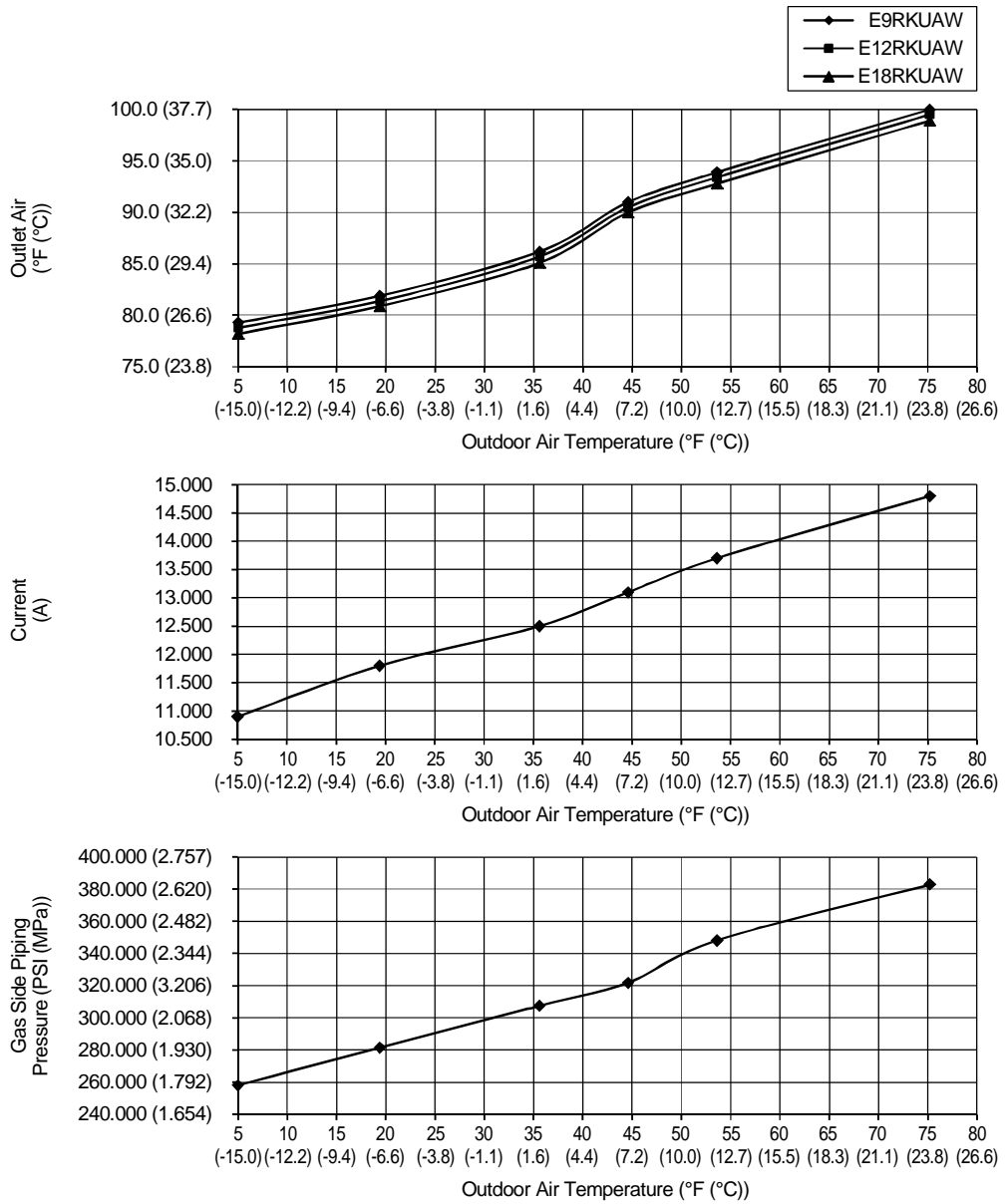

17.2.1.4 Four Indoor Unit Operation

- Cooling Characteristic

[Condition] Room temperature: 80.0°F (26.7°C) (DBT), 67.0°F (19.4°C) (WBT)

Operation condition: High fan speed

Piping Length: 7.5m (24.6 ft)

230V 60Hz

A) Indoor unit capacity: Cooling (2.0 + 2.5 + 3.2 + 5.0: CS-ME7RKUA + CS-E9RKUAW + CS-E12RKUAW + CS-E18RKUAW), service mode frequency = 65Hz

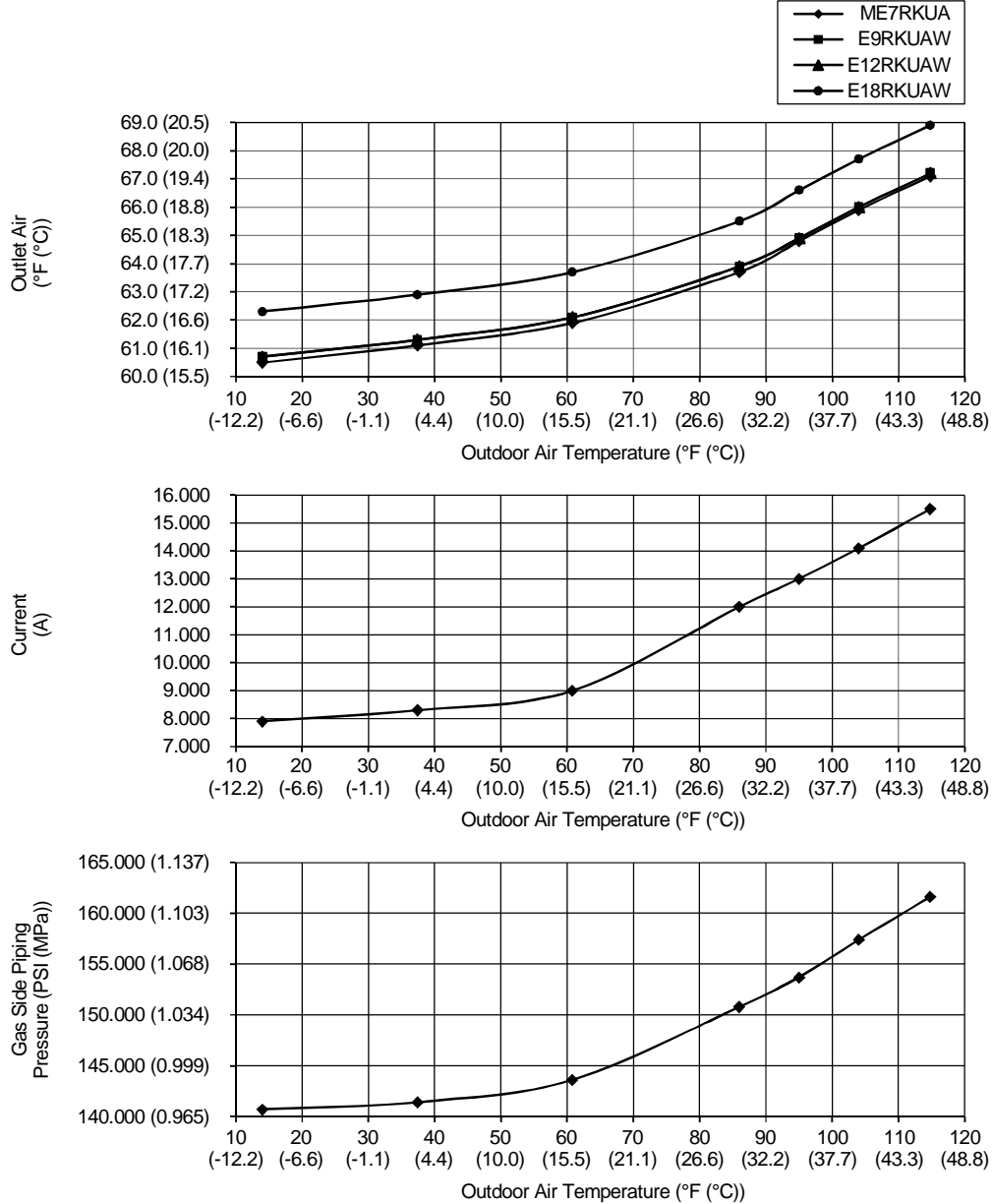

- Heating Characteristic

[Condition] Room temperature: 70.0°F (21.1°C) (DBT), 60.0°F (15.6°C) (WBT)

Operation condition: High fan speed

Piping Length: 7.5m (24.6 ft)

230V 60Hz

A) Indoor unit capacity: Heating (2.0 + 2.5 + 3.2 + 5.0: CS-ME7RKUA + CS-E9RKUAW + CS-E12RKUAW + CS-E18RKUAW), service mode frequency = 86Hz

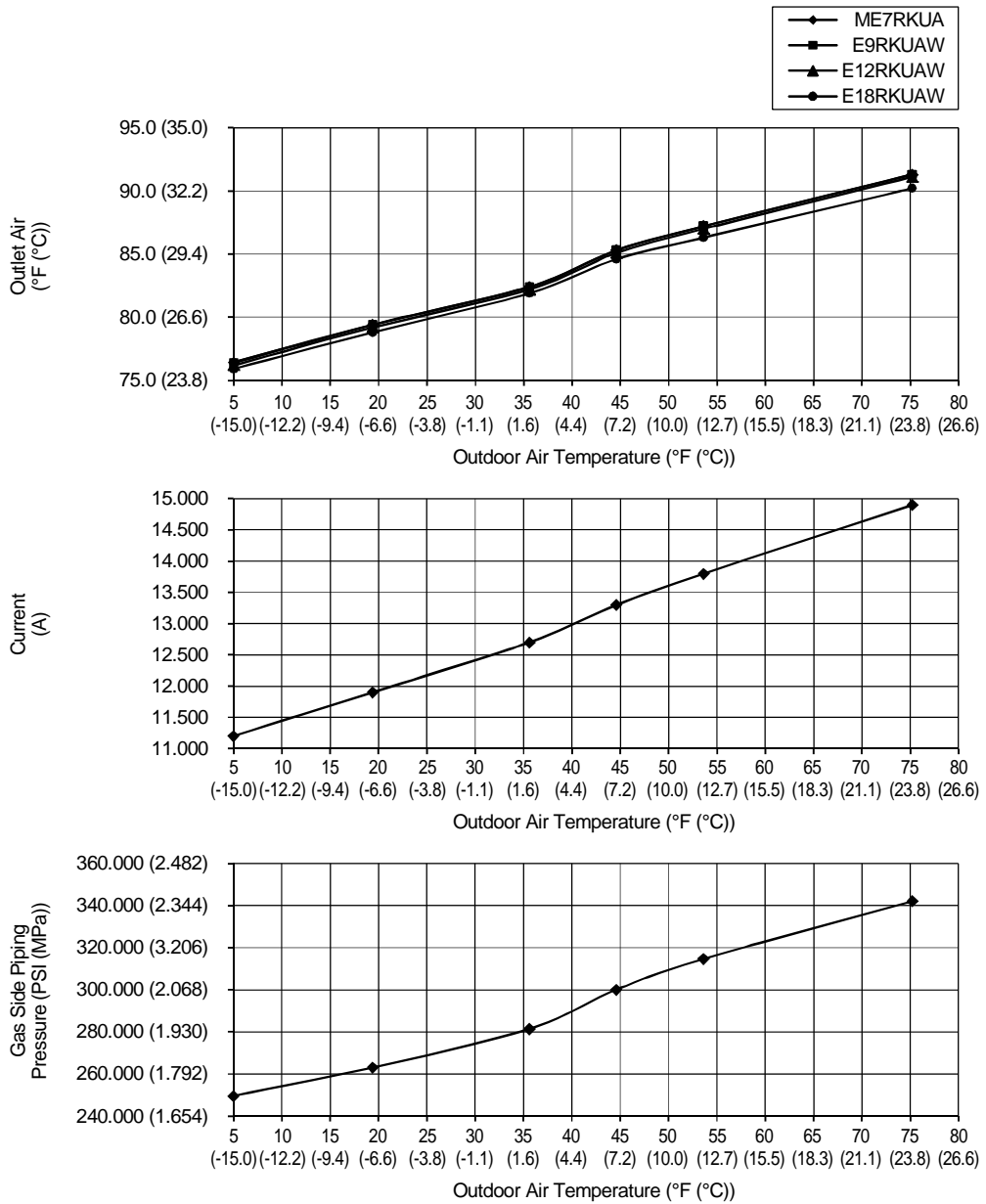

17.2.2 Capacity Table

17.2.2.1 Cooling

Cooling: 60Hz, 230V

Maximum capacity and Input power

Combination (Capacity)	Outdoor Air Temp. °F (°C) DB	Indoor Air Temp. °F (°C) WB											
		60.8 (16)		63.5 (17.5)		64.4 (18)		66.2 (19)		71.6 (22)		75.2 (24)	
		Total Capacity (BTU/h)	Input Power (kW)	Total Capacity (BTU/h)	Input Power (kW)	Total Capacity (BTU/h)	Input Power (kW)	Total Capacity (BTU/h)	Input Power (kW)	Total Capacity (BTU/h)	Input Power (kW)	Total Capacity (BTU/h)	Input Power (kW)
1.6 + 3.2	71.6 (22)	13784.48	0.64	14102.93	0.64	14209.08	0.64	14421.39	0.64	19921.53	1.03	23588.29	1.29
	77.0 (25)	15717.95	1.08	16127.39	1.06	16263.87	1.06	16536.83	1.05	20658.52	1.30	23406.32	1.46
	84.2 (29)	17605.92	1.56	18060.85	1.53	18212.50	1.52	18515.79	1.51	21163.50	1.62	22928.64	1.69
	89.6 (32)	18424.80	1.83	18925.23	1.81	19092.04	1.80	19425.65	1.79	23693.36	1.81	26538.50	1.83
	95.0 (35)	18743.25	2.04	19266.43	2.03	19440.82	2.02	19789.60	2.01	21004.27	1.98	21814.05	1.96
	104.0 (40)	18220.08	2.24	18743.25	2.25	18917.64	2.25	19266.43	2.26	18638.62	2.20	18220.08	2.16
	109.4 (43)	17219.23	2.24	17742.40	2.29	17916.79	2.30	18265.57	2.33	19016.21	2.29	19516.64	2.26
	114.8 (46)	15695.20	2.19	16218.37	2.27	16392.76	2.30	16741.55	2.35	17751.50	2.34	18424.80	2.33
1.6 + 5.0	71.6 (22)	17111.77	0.83	17507.09	0.83	17638.86	0.83	17902.41	0.83	24730.18	1.33	29282.02	1.67
	77.0 (25)	19511.93	1.40	20020.20	1.38	20189.63	1.37	20528.47	1.36	25645.06	1.68	29056.12	1.90
	84.2 (29)	21855.62	2.02	22420.37	1.99	22608.62	1.98	22985.11	1.96	26271.93	2.10	28463.14	2.19
	89.6 (32)	22872.17	2.38	23493.38	2.35	23700.46	2.34	24114.60	2.32	29412.45	2.36	32944.34	2.38
	95.0 (35)	23267.49	2.65	23916.94	2.63	24133.43	2.62	24566.40	2.61	26074.27	2.57	27079.51	2.55
	104.0 (40)	22618.03	2.91	23267.49	2.92	23483.97	2.92	23916.94	2.93	23137.60	2.85	22618.03	2.80
	109.4 (43)	21375.59	2.91	22025.05	2.97	22241.53	2.99	22674.50	3.03	23606.33	2.97	24227.55	2.93
	114.8 (46)	19483.70	2.85	20133.15	2.95	20349.64	2.98	20782.61	3.05	22036.34	3.04	22872.17	3.03
1.6 + 7.0	71.6 (22)	20201.39	1.15	20668.09	1.15	20823.66	1.15	21134.79	1.15	29195.35	1.85	34569.05	2.31
	77.0 (25)	23034.92	1.94	23634.96	1.91	23834.98	1.90	24235.00	1.88	30275.42	2.33	34302.37	2.63
	84.2 (29)	25801.78	2.79	26468.49	2.75	26690.73	2.74	27135.20	2.71	31015.47	2.90	33602.32	3.03
	89.6 (32)	27001.86	3.29	27735.25	3.25	27979.71	3.24	28468.63	3.21	34723.03	3.26	38892.63	3.29
	95.0 (35)	27468.56	3.67	28235.28	3.64	28490.85	3.63	29002.00	3.61	30782.12	3.56	31968.87	3.53
	104.0 (40)	26701.84	4.02	27468.56	4.04	27724.13	4.04	28235.28	4.05	27315.22	3.94	26701.84	3.87
	109.4 (43)	25235.07	4.02	26001.79	4.11	26257.37	4.14	26768.51	4.19	27868.59	4.11	28601.97	4.05
	114.8 (46)	23001.59	3.94	23768.31	4.08	24023.88	4.13	24535.03	4.22	26015.13	4.20	27001.86	4.19
2.0 + 2.5	71.6 (22)	13784.48	0.66	14102.93	0.66	14209.08	0.66	14421.39	0.66	19921.53	1.06	23588.29	1.32
	77.0 (25)	15717.95	1.11	16127.39	1.09	16263.87	1.09	16536.83	1.08	20658.52	1.34	23406.32	1.51
	84.2 (29)	17605.92	1.60	18060.85	1.58	18212.50	1.57	18515.79	1.55	21163.50	1.66	22928.64	1.74
	89.6 (32)	18424.80	1.89	18925.23	1.86	19092.04	1.86	19425.65	1.84	23693.36	1.87	26538.50	1.89
	95.0 (35)	18743.25	2.10	19266.43	2.09	19440.82	2.08	19789.60	2.07	21004.27	2.04	21814.05	2.02
	104.0 (40)	18220.08	2.31	18743.25	2.32	18917.64	2.32	19266.43	2.32	18638.62	2.26	18220.08	2.22
	109.4 (43)	17219.23	2.31	17742.40	2.36	17916.79	2.37	18265.57	2.40	19016.21	2.36	19516.64	2.32
	114.8 (46)	15695.20	2.26	16218.37	2.34	16392.76	2.37	16741.55	2.42	17751.50	2.41	18424.80	2.40

Combination (Capacity)	Outdoor Air Temp. °F (°C) DB	Indoor Air Temp. °F (°C) WB											
		60.8 (16)		63.5 (17.5)		64.4 (18)		66.2 (19)		71.6 (22)		75.2 (24)	
		Total Capacity (BTU/h)	Input Power (kW)	Total Capacity (BTU/h)	Input Power (kW)	Total Capacity (BTU/h)	Input Power (kW)	Total Capacity (BTU/h)	Input Power (kW)	Total Capacity (BTU/h)	Input Power (kW)	Total Capacity (BTU/h)	Input Power (kW)
2.0 + 3.2	71.6 (22)	13784.48	0.62	14102.93	0.62	14209.08	0.62	14421.39	0.62	19921.53	1.00	23588.29	1.25
	77.0 (25)	15717.95	1.05	16127.39	1.03	16263.87	1.03	16536.83	1.02	20658.52	1.26	23406.32	1.42
	84.2 (29)	17605.92	1.51	18060.85	1.49	18212.50	1.48	18515.79	1.46	21163.50	1.57	22928.64	1.64
	89.6 (32)	18424.80	1.78	18925.23	1.76	19092.04	1.75	19425.65	1.73	23693.36	1.76	26538.50	1.78
	95.0 (35)	18743.25	1.98	19266.43	1.96	19440.82	1.96	19789.60	1.95	21004.27	1.92	21814.05	1.91
	104.0 (40)	18220.08	2.17	18743.25	2.18	18917.64	2.18	19266.43	2.19	18638.62	2.13	18220.08	2.09
	109.4 (43)	17219.23	2.17	17742.40	2.22	17916.79	2.23	18265.57	2.26	19016.21	2.22	19516.64	2.19
	114.8 (46)	15695.20	2.13	16218.37	2.20	16392.76	2.23	16741.55	2.28	17751.50	2.27	18424.80	2.26
2.0 + 5.0	71.6 (22)	19250.74	1.07	19695.48	1.07	19843.72	1.07	20140.21	1.07	27821.45	1.72	32942.27	2.16
	77.0 (25)	21950.93	1.81	22522.73	1.78	22713.33	1.77	23094.53	1.76	28850.70	2.17	32688.14	2.45
	84.2 (29)	24587.58	2.61	25222.92	2.57	25434.70	2.56	25858.25	2.53	29555.92	2.71	32021.03	2.83
	89.6 (32)	25731.19	3.07	26430.06	3.03	26663.02	3.02	27128.93	3.00	33089.00	3.04	37062.39	3.07
	95.0 (35)	26175.92	3.42	26906.56	3.40	27150.11	3.39	27637.20	3.37	29333.55	3.32	30464.45	3.29
	104.0 (40)	25445.28	3.76	26175.92	3.77	26419.47	3.77	26906.56	3.78	26029.80	3.68	25445.28	3.62
	109.4 (43)	24047.54	3.76	24778.18	3.83	25021.73	3.86	25508.82	3.91	26557.13	3.83	27256.00	3.78
	114.8 (46)	21919.16	3.68	22649.80	3.81	22893.34	3.85	23380.44	3.94	24790.89	3.92	25731.19	3.91
2.0 + 7.0	71.6 (22)	20201.39	1.15	20668.09	1.15	20823.66	1.15	21134.79	1.15	29195.35	1.85	34569.05	2.31
	77.0 (25)	23034.92	1.94	23634.96	1.91	23834.98	1.90	24235.00	1.88	30275.42	2.33	34302.37	2.63
	84.2 (29)	25801.78	2.79	26468.49	2.75	26690.73	2.74	27135.20	2.71	31015.47	2.90	33602.32	3.03
	89.6 (32)	27001.86	3.29	27735.25	3.25	27979.71	3.24	28468.63	3.21	34723.03	3.26	38892.63	3.29
	95.0 (35)	27468.56	3.67	28235.28	3.64	28490.85	3.63	29002.00	3.61	30782.12	3.56	31968.87	3.53
	104.0 (40)	26701.84	4.02	27468.56	4.04	27724.13	4.04	28235.28	4.05	27315.22	3.94	26701.84	3.87
	109.4 (43)	25235.07	4.02	26001.79	4.11	26257.37	4.14	26768.51	4.19	27868.59	4.11	28601.97	4.05
	114.8 (46)	23001.59	3.94	23768.31	4.08	24023.88	4.13	24535.03	4.22	26015.13	4.20	27001.86	4.19
2.5 + 2.5	71.6 (22)	13784.48	0.66	14102.93	0.66	14209.08	0.66	14421.39	0.66	19921.53	1.06	23588.29	1.32
	77.0 (25)	15717.95	1.11	16127.39	1.09	16263.87	1.09	16536.83	1.08	20658.52	1.34	23406.32	1.51
	84.2 (29)	17605.92	1.60	18060.85	1.58	18212.50	1.57	18515.79	1.55	21163.50	1.66	22928.64	1.74
	89.6 (32)	18424.80	1.89	18925.23	1.86	19092.04	1.86	19425.65	1.84	23693.36	1.87	26538.50	1.89
	95.0 (35)	18743.25	2.10	19266.43	2.09	19440.82	2.08	19789.60	2.07	21004.27	2.04	21814.05	2.02
	104.0 (40)	18220.08	2.31	18743.25	2.32	18917.64	2.32	19266.43	2.32	18638.62	2.26	18220.08	2.22
	109.4 (43)	17219.23	2.31	17742.40	2.36	17916.79	2.37	18265.57	2.40	19016.21	2.36	19516.64	2.32
	114.8 (46)	15695.20	2.26	16218.37	2.34	16392.76	2.37	16741.55	2.42	17751.50	2.41	18424.80	2.40

Combination (Capacity)	Outdoor Air Temp. °F (°C) DB	Indoor Air Temp. °F (°C) WB											
		60.8 (16)		63.5 (17.5)		64.4 (18)		66.2 (19)		71.6 (22)		75.2 (24)	
		Total Capacity (BTU/h)	Input Power (kW)	Total Capacity (BTU/h)	Input Power (kW)	Total Capacity (BTU/h)	Input Power (kW)	Total Capacity (BTU/h)	Input Power (kW)	Total Capacity (BTU/h)	Input Power (kW)	Total Capacity (BTU/h)	Input Power (kW)
2.5 + 3.2	71.6 (22)	15923.45	0.85	16291.32	0.85	16413.94	0.85	16659.19	0.85	23012.80	1.37	27248.55	1.71
	77.0 (25)	18156.94	1.44	18629.91	1.42	18787.57	1.41	19102.89	1.40	23864.16	1.73	27038.34	1.95
	84.2 (29)	20337.87	2.07	20863.40	2.04	21038.58	2.03	21388.93	2.01	24447.49	2.15	26486.53	2.25
	89.6 (32)	21283.82	2.44	21861.90	2.41	22054.59	2.40	22439.98	2.38	27369.92	2.42	30656.54	2.44
	95.0 (35)	21651.69	2.72	22256.04	2.70	22457.50	2.69	22860.40	2.68	24263.56	2.64	25198.99	2.62
	104.0 (40)	21047.33	2.99	21651.69	3.00	21853.14	3.00	22256.04	3.01	21530.82	2.93	21047.33	2.88
	109.4 (43)	19891.18	2.99	20495.53	3.05	20696.98	3.07	21099.89	3.11	21967.01	3.05	22545.08	3.01
	114.8 (46)	18130.66	2.93	18735.02	3.03	18936.47	3.06	19339.37	3.13	20506.04	3.12	21283.82	3.11
2.5 + 5.0	71.6 (22)	20201.39	1.20	20668.09	1.20	20823.66	1.20	21134.79	1.20	29195.35	1.93	34569.05	2.42
	77.0 (25)	23034.92	2.03	23634.96	2.00	23834.98	1.99	24235.00	1.97	30275.42	2.44	34302.37	2.75
	84.2 (29)	25801.78	2.93	26468.49	2.88	26690.73	2.87	27135.20	2.84	31015.47	3.04	33602.32	3.17
	89.6 (32)	27001.86	3.45	27735.25	3.40	27979.71	3.39	28468.63	3.36	34723.03	3.41	38892.63	3.45
	95.0 (35)	27468.56	3.84	28235.28	3.81	28490.85	3.80	29002.00	3.78	30782.12	3.73	31968.87	3.69
	104.0 (40)	26701.84	4.21	27468.56	4.23	27724.13	4.23	28235.28	4.24	27315.22	4.13	26701.84	4.06
	109.4 (43)	25235.07	4.21	26001.79	4.30	26257.37	4.33	26768.51	4.39	27868.59	4.30	28601.97	4.24
	114.8 (46)	23001.59	4.13	23768.31	4.27	24023.88	4.32	24535.03	4.42	26015.13	4.40	27001.86	4.39
2.5 + 7.0	71.6 (22)	20201.39	1.15	20668.09	1.15	20823.66	1.15	21134.79	1.15	29195.35	1.85	34569.05	2.31
	77.0 (25)	23034.92	1.94	23634.96	1.91	23834.98	1.90	24235.00	1.88	30275.42	2.33	34302.37	2.63
	84.2 (29)	25801.78	2.79	26468.49	2.75	26690.73	2.74	27135.20	2.71	31015.47	2.90	33602.32	3.03
	89.6 (32)	27001.86	3.29	27735.25	3.25	27979.71	3.24	28468.63	3.21	34723.03	3.26	38892.63	3.29
	95.0 (35)	27468.56	3.67	28235.28	3.64	28490.85	3.63	29002.00	3.61	30782.12	3.56	31968.87	3.53
	104.0 (40)	26701.84	4.02	27468.56	4.04	27724.13	4.04	28235.28	4.05	27315.22	3.94	26701.84	3.87
	109.4 (43)	25235.07	4.02	26001.79	4.11	26257.37	4.14	26768.51	4.19	27868.59	4.11	28601.97	4.05
	114.8 (46)	23001.59	3.94	23768.31	4.08	24023.88	4.13	24535.03	4.22	26015.13	4.20	27001.86	4.19
3.2 + 3.2	71.6 (22)	17111.77	0.94	17507.09	0.94	17638.86	0.94	17902.41	0.94	24730.18	1.52	29282.02	1.90
	77.0 (25)	19511.93	1.59	20020.20	1.57	20189.63	1.56	20528.47	1.55	25645.06	1.92	29056.12	2.16
	84.2 (29)	21855.62	2.30	22420.37	2.26	22608.62	2.25	22985.11	2.23	26271.93	2.39	28463.14	2.49
	89.6 (32)	22872.17	2.71	23493.38	2.67	23700.46	2.66	24114.60	2.64	29412.45	2.68	32944.34	2.71
	95.0 (35)	23267.49	3.02	23916.94	2.99	24133.43	2.99	24566.40	2.97	26074.27	2.93	27079.51	2.90
	104.0 (40)	22618.03	3.31	23267.49	3.32	23483.97	3.33	23916.94	3.33	23137.60	3.25	22618.03	3.19
	109.4 (43)	21375.59	3.31	22025.05	3.38	22241.53	3.40	22674.50	3.45	23606.33	3.38	24227.55	3.33
	114.8 (46)	19483.70	3.24	20133.15	3.36	20349.64	3.39	20782.61	3.47	22036.34	3.46	22872.17	3.45

Combination (Capacity)	Outdoor Air Temp. °F (°C) DB	Indoor Air Temp. °F (°C) WB											
		60.8 (16)		63.5 (17.5)		64.4 (18)		66.2 (19)		71.6 (22)		75.2 (24)	
		Total Capacity (BTU/h)	Input Power (kW)	Total Capacity (BTU/h)	Input Power (kW)	Total Capacity (BTU/h)	Input Power (kW)	Total Capacity (BTU/h)	Input Power (kW)	Total Capacity (BTU/h)	Input Power (kW)	Total Capacity (BTU/h)	Input Power (kW)
3.2 + 5.0	71.6 (22)	20201.39	1.15	20668.09	1.15	20823.66	1.15	21134.79	1.15	29195.35	1.85	34569.05	2.31
	77.0 (25)	23034.92	1.94	23634.96	1.91	23834.98	1.90	24235.00	1.88	30275.42	2.33	34302.37	2.63
	84.2 (29)	25801.78	2.79	26468.49	2.75	26690.73	2.74	27135.20	2.71	31015.47	2.90	33602.32	3.03
	89.6 (32)	27001.86	3.29	27735.25	3.25	27979.71	3.24	28468.63	3.21	34723.03	3.26	38892.63	3.29
	95.0 (35)	27468.56	3.67	28235.28	3.64	28490.85	3.63	29002.00	3.61	30782.12	3.56	31968.87	3.53
	104.0 (40)	26701.84	4.02	27468.56	4.04	27724.13	4.04	28235.28	4.05	27315.22	3.94	26701.84	3.87
	109.4 (43)	25235.07	4.02	26001.79	4.11	26257.37	4.14	26768.51	4.19	27868.59	4.11	28601.97	4.05
	114.8 (46)	23001.59	3.94	23768.31	4.08	24023.88	4.13	24535.03	4.22	26015.13	4.20	27001.86	4.19
3.2 + 7.0	71.6 (22)	20439.06	1.15	20911.25	1.15	21068.64	1.15	21383.44	1.15	29538.82	1.85	34975.75	2.32
	77.0 (25)	23305.92	1.94	23913.02	1.91	24115.39	1.90	24520.12	1.89	30631.60	2.34	34705.92	2.64
	84.2 (29)	26105.33	2.80	26779.89	2.76	27004.74	2.75	27454.44	2.72	31380.36	2.91	33997.64	3.04
	89.6 (32)	27319.53	3.30	28061.54	3.26	28308.88	3.25	28803.55	3.22	35131.53	3.27	39350.19	3.30
	95.0 (35)	27791.72	3.68	28567.46	3.65	28826.04	3.64	29343.20	3.62	31144.27	3.57	32344.98	3.54
	104.0 (40)	27015.98	4.04	27791.72	4.05	28050.30	4.05	28567.46	4.06	27636.57	3.96	27015.98	3.88
	109.4 (43)	25531.96	4.04	26307.70	4.12	26566.28	4.15	27083.44	4.20	28196.45	4.12	28938.47	4.06
	114.8 (46)	23272.19	3.95	24047.93	4.09	24306.51	4.14	24823.67	4.23	26321.19	4.21	27319.53	4.20
5.0 + 5.0	71.6 (22)	20439.06	1.02	20911.25	1.02	21068.64	1.02	21383.44	1.02	29538.82	1.64	34975.75	2.05
	77.0 (25)	23305.92	1.72	23913.02	1.70	24115.39	1.69	24520.12	1.67	30631.60	2.07	34705.92	2.34
	84.2 (29)	26105.33	2.48	26779.89	2.45	27004.74	2.44	27454.44	2.41	31380.36	2.58	33997.64	2.69
	89.6 (32)	27319.53	2.93	28061.54	2.89	28308.88	2.88	28803.55	2.85	35131.53	2.90	39350.19	2.93
	95.0 (35)	27791.72	3.26	28567.46	3.23	28826.04	3.23	29343.20	3.21	31144.27	3.17	32344.98	3.14
	104.0 (40)	27015.98	3.58	27791.72	3.59	28050.30	3.60	28567.46	3.60	27636.57	3.51	27015.98	3.44
	109.4 (43)	25531.96	3.58	26307.70	3.65	26566.28	3.68	27083.44	3.73	28196.45	3.65	28938.47	3.60
	114.8 (46)	23272.19	3.51	24047.93	3.63	24306.51	3.67	24823.67	3.75	26321.19	3.74	27319.53	3.73
5.0 + 7.0	71.6 (22)	20439.06	1.00	20911.25	1.00	21068.64	1.00	21383.44	1.00	29538.82	1.60	34975.75	2.00
	77.0 (25)	23305.92	1.68	23913.02	1.65	24115.39	1.65	24520.12	1.63	30631.60	2.02	34705.92	2.28
	84.2 (29)	26105.33	2.42	26779.89	2.39	27004.74	2.37	27454.44	2.35	31380.36	2.52	33997.64	2.63
	89.6 (32)	27319.53	2.85	28061.54	2.82	28308.88	2.81	28803.55	2.78	35131.53	2.83	39350.19	2.85
	95.0 (35)	27791.72	3.18	28567.46	3.15	28826.04	3.15	29343.20	3.13	31144.27	3.09	32344.98	3.06
	104.0 (40)	27015.98	3.49	27791.72	3.50	28050.30	3.51	28567.46	3.51	27636.57	3.42	27015.98	3.36
	109.4 (43)	25531.96	3.49	26307.70	3.56	26566.28	3.59	27083.44	3.63	28196.45	3.56	28938.47	3.51
	114.8 (46)	23272.19	3.42	24047.93	3.54	24306.51	3.58	24823.67	3.66	26321.19	3.64	27319.53	3.63

Combination (Capacity)	Outdoor Air Temp. °F (°C) DB	Indoor Air Temp. °F (°C) WB											
		60.8 (16)		63.5 (17.5)		64.4 (18)		66.2 (19)		71.6 (22)		75.2 (24)	
		Total Capacity (BTU/h)	Input Power (kW)	Total Capacity (BTU/h)	Input Power (kW)	Total Capacity (BTU/h)	Input Power (kW)	Total Capacity (BTU/h)	Input Power (kW)	Total Capacity (BTU/h)	Input Power (kW)	Total Capacity (BTU/h)	Input Power (kW)
1.6 + 1.6 + 1.6	71.6 (22)	20201.39	1.02	20668.09	1.02	20823.66	1.02	21134.79	1.02	29195.35	1.65	34569.05	2.06
	77.0 (25)	23034.92	1.73	23634.96	1.70	23834.98	1.69	24235.00	1.68	30275.42	2.08	34302.37	2.34
	84.2 (29)	25801.78	2.49	26468.49	2.46	26690.73	2.44	27135.20	2.42	31015.47	2.59	33602.32	2.70
	89.6 (32)	27001.86	2.94	27735.25	2.90	27979.71	2.89	28468.63	2.86	34723.03	2.91	38892.63	2.94
	95.0 (35)	27468.56	3.27	28235.28	3.24	28490.85	3.24	29002.00	3.22	30782.12	3.18	31968.87	3.15
	104.0 (40)	26701.84	3.59	27468.56	3.60	27724.13	3.61	28235.28	3.61	27315.22	3.52	26701.84	3.45
	109.4 (43)	25235.07	3.59	26001.79	3.66	26257.37	3.69	26768.51	3.74	27868.59	3.66	28601.97	3.61
	114.8 (46)	23001.59	3.52	23768.31	3.64	24023.88	3.68	24535.03	3.76	26015.13	3.75	27001.86	3.74
1.6 + 1.6 + 2.0	71.6 (22)	20201.39	1.02	20668.09	1.02	20823.66	1.02	21134.79	1.02	29195.35	1.65	34569.05	2.06
	77.0 (25)	23034.92	1.73	23634.96	1.70	23834.98	1.69	24235.00	1.68	30275.42	2.08	34302.37	2.34
	84.2 (29)	25801.78	2.49	26468.49	2.46	26690.73	2.44	27135.20	2.42	31015.47	2.59	33602.32	2.70
	89.6 (32)	27001.86	2.94	27735.25	2.90	27979.71	2.89	28468.63	2.86	34723.03	2.91	38892.63	2.94
	95.0 (35)	27468.56	3.27	28235.28	3.24	28490.85	3.24	29002.00	3.22	30782.12	3.18	31968.87	3.15
	104.0 (40)	26701.84	3.59	27468.56	3.60	27724.13	3.61	28235.28	3.61	27315.22	3.52	26701.84	3.45
	109.4 (43)	25235.07	3.59	26001.79	3.66	26257.37	3.69	26768.51	3.74	27868.59	3.66	28601.97	3.61
	114.8 (46)	23001.59	3.52	23768.31	3.64	24023.88	3.68	24535.03	3.76	26015.13	3.75	27001.86	3.74
1.6 + 1.6 + 2.5	71.6 (22)	20201.39	1.02	20668.09	1.02	20823.66	1.02	21134.79	1.02	29195.35	1.65	34569.05	2.06
	77.0 (25)	23034.92	1.73	23634.96	1.70	23834.98	1.69	24235.00	1.68	30275.42	2.08	34302.37	2.34
	84.2 (29)	25801.78	2.49	26468.49	2.46	26690.73	2.44	27135.20	2.42	31015.47	2.59	33602.32	2.70
	89.6 (32)	27001.86	2.94	27735.25	2.90	27979.71	2.89	28468.63	2.86	34723.03	2.91	38892.63	2.94
	95.0 (35)	27468.56	3.27	28235.28	3.24	28490.85	3.24	29002.00	3.22	30782.12	3.18	31968.87	3.15
	104.0 (40)	26701.84	3.59	27468.56	3.60	27724.13	3.61	28235.28	3.61	27315.22	3.52	26701.84	3.45
	109.4 (43)	25235.07	3.59	26001.79	3.66	26257.37	3.69	26768.51	3.74	27868.59	3.66	28601.97	3.61
	114.8 (46)	23001.59	3.52	23768.31	3.64	24023.88	3.68	24535.03	3.76	26015.13	3.75	27001.86	3.74
1.6 + 1.6 + 3.2	71.6 (22)	20201.39	0.98	20668.09	0.98	20823.66	0.98	21134.79	0.98	29195.35	1.57	34569.05	1.96
	77.0 (25)	23034.92	1.65	23634.96	1.62	23834.98	1.62	24235.00	1.60	30275.42	1.98	34302.37	2.23
	84.2 (29)	25801.78	2.38	26468.49	2.34	26690.73	2.33	27135.20	2.31	31015.47	2.47	33602.32	2.58
	89.6 (32)	27001.86	2.80	27735.25	2.76	27979.71	2.75	28468.63	2.73	34723.03	2.77	38892.63	2.80
	95.0 (35)	27468.56	3.12	28235.28	3.09	28490.85	3.09	29002.00	3.07	30782.12	3.03	31968.87	3.00
	104.0 (40)	26701.84	3.42	27468.56	3.43	27724.13	3.44	28235.28	3.45	27315.22	3.35	26701.84	3.29
	109.4 (43)	25235.07	3.42	26001.79	3.49	26257.37	3.52	26768.51	3.56	27868.59	3.49	28601.97	3.45
	114.8 (46)	23001.59	3.35	23768.31	3.47	24023.88	3.51	24535.03	3.59	26015.13	3.57	27001.86	3.56

Combination (Capacity)	Outdoor Air Temp. °F (°C) DB	Indoor Air Temp. °F (°C) WB											
		60.8 (16)		63.5 (17.5)		64.4 (18)		66.2 (19)		71.6 (22)		75.2 (24)	
		Total Capacity (BTU/h)	Input Power (kW)	Total Capacity (BTU/h)	Input Power (kW)	Total Capacity (BTU/h)	Input Power (kW)	Total Capacity (BTU/h)	Input Power (kW)	Total Capacity (BTU/h)	Input Power (kW)	Total Capacity (BTU/h)	Input Power (kW)
1.6 + 1.6 + 5.0	71.6 (22)	20439.06	0.90	20911.25	0.90	21068.64	0.90	21383.44	0.90	29538.82	1.45	34975.75	1.82
	77.0 (25)	23305.92	1.52	23913.02	1.50	24115.39	1.49	24520.12	1.48	30631.60	1.83	34705.92	2.07
	84.2 (29)	26105.33	2.20	26779.89	2.17	27004.74	2.15	27454.44	2.13	31380.36	2.28	33997.64	2.38
	89.6 (32)	27319.53	2.59	28061.54	2.56	28308.88	2.55	28803.55	2.52	35131.53	2.56	39350.19	2.59
	95.0 (35)	27791.72	2.88	28567.46	2.86	28826.04	2.85	29343.20	2.84	31144.27	2.80	32344.98	2.77
	104.0 (40)	27015.98	3.17	27791.72	3.18	28050.30	3.18	28567.46	3.19	27636.57	3.10	27015.98	3.05
	109.4 (43)	25531.96	3.17	26307.70	3.23	26566.28	3.25	27083.44	3.30	28196.45	3.23	28938.47	3.19
	114.8 (46)	23272.19	3.10	24047.93	3.21	24306.51	3.25	24823.67	3.32	26321.19	3.31	27319.53	3.30
1.6 + 1.6 + 7.0	71.6 (22)	20914.38	0.93	21397.55	0.93	21558.61	0.93	21880.72	0.93	30225.77	1.49	35789.13	1.86
	77.0 (25)	23847.92	1.56	24469.14	1.54	24676.21	1.53	25090.36	1.52	31343.97	1.88	35513.04	2.12
	84.2 (29)	26712.43	2.25	27402.67	2.22	27632.76	2.21	28092.92	2.19	32110.14	2.34	34788.28	2.44
	89.6 (32)	27954.87	2.65	28714.14	2.62	28967.23	2.61	29473.41	2.59	35948.55	2.63	40265.31	2.65
	95.0 (35)	28438.04	2.95	29231.82	2.93	29496.41	2.92	30025.60	2.91	31868.55	2.87	33097.18	2.84
	104.0 (40)	27644.26	3.24	28438.04	3.26	28702.63	3.26	29231.82	3.27	28279.28	3.18	27644.26	3.12
	109.4 (43)	26125.72	3.24	26919.50	3.31	27184.10	3.33	27713.28	3.38	28852.19	3.31	29611.45	3.27
	114.8 (46)	23813.41	3.18	24607.19	3.29	24871.78	3.33	25400.97	3.40	26933.31	3.39	27954.87	3.38
1.6 + 2.0 + 2.0	71.6 (22)	20201.39	1.00	20668.09	1.00	20823.66	1.00	21134.79	1.00	29195.35	1.61	34569.05	2.02
	77.0 (25)	23034.92	1.69	23634.96	1.67	23834.98	1.66	24235.00	1.64	30275.42	2.03	34302.37	2.29
	84.2 (29)	25801.78	2.44	26468.49	2.40	26690.73	2.39	27135.20	2.37	31015.47	2.53	33602.32	2.64
	89.6 (32)	27001.86	2.87	27735.25	2.84	27979.71	2.82	28468.63	2.80	34723.03	2.84	38892.63	2.87
	95.0 (35)	27468.56	3.20	28235.28	3.17	28490.85	3.17	29002.00	3.15	30782.12	3.11	31968.87	3.08
	104.0 (40)	26701.84	3.51	27468.56	3.52	27724.13	3.53	28235.28	3.54	27315.22	3.44	26701.84	3.38
	109.4 (43)	25235.07	3.51	26001.79	3.58	26257.37	3.61	26768.51	3.66	27868.59	3.58	28601.97	3.54
	114.8 (46)	23001.59	3.44	23768.31	3.56	24023.88	3.60	24535.03	3.68	26015.13	3.67	27001.86	3.66
1.6 + 2.0 + 2.5	71.6 (22)	20201.39	1.00	20668.09	1.00	20823.66	1.00	21134.79	1.00	29195.35	1.61	34569.05	2.02
	77.0 (25)	23034.92	1.69	23634.96	1.67	23834.98	1.66	24235.00	1.64	30275.42	2.03	34302.37	2.29
	84.2 (29)	25801.78	2.44	26468.49	2.40	26690.73	2.39	27135.20	2.37	31015.47	2.53	33602.32	2.64
	89.6 (32)	27001.86	2.87	27735.25	2.84	27979.71	2.82	28468.63	2.80	34723.03	2.84	38892.63	2.87
	95.0 (35)	27468.56	3.20	28235.28	3.17	28490.85	3.17	29002.00	3.15	30782.12	3.11	31968.87	3.08
	104.0 (40)	26701.84	3.51	27468.56	3.52	27724.13	3.53	28235.28	3.54	27315.22	3.44	26701.84	3.38
	109.4 (43)	25235.07	3.51	26001.79	3.58	26257.37	3.61	26768.51	3.66	27868.59	3.58	28601.97	3.54
	114.8 (46)	23001.59	3.44	23768.31	3.56	24023.88	3.60	24535.03	3.68	26015.13	3.67	27001.86	3.66

Combination (Capacity)	Outdoor Air Temp. °F (°C) DB	Indoor Air Temp. °F (°C) WB											
		60.8 (16)		63.5 (17.5)		64.4 (18)		66.2 (19)		71.6 (22)		75.2 (24)	
		Total Capacity (BTU/h)	Input Power (kW)	Total Capacity (BTU/h)	Input Power (kW)	Total Capacity (BTU/h)	Input Power (kW)	Total Capacity (BTU/h)	Input Power (kW)	Total Capacity (BTU/h)	Input Power (kW)	Total Capacity (BTU/h)	Input Power (kW)
1.6 + 2.0 + 3.2	71.6 (22)	20201.39	0.98	20668.09	0.98	20823.66	0.98	21134.79	0.98	29195.35	1.57	34569.05	1.96
	77.0 (25)	23034.92	1.65	23634.96	1.62	23834.98	1.62	24235.00	1.60	30275.42	1.98	34302.37	2.23
	84.2 (29)	25801.78	2.38	26468.49	2.34	26690.73	2.33	27135.20	2.31	31015.47	2.47	33602.32	2.58
	89.6 (32)	27001.86	2.80	27735.25	2.76	27979.71	2.75	28468.63	2.73	34723.03	2.77	38892.63	2.80
	95.0 (35)	27468.56	3.12	28235.28	3.09	28490.85	3.09	29002.00	3.07	30782.12	3.03	31968.87	3.00
	104.0 (40)	26701.84	3.42	27468.56	3.43	27724.13	3.44	28235.28	3.45	27315.22	3.35	26701.84	3.29
	109.4 (43)	25235.07	3.42	26001.79	3.49	26257.37	3.52	26768.51	3.56	27868.59	3.49	28601.97	3.45
	114.8 (46)	23001.59	3.35	23768.31	3.47	24023.88	3.51	24535.03	3.59	26015.13	3.57	27001.86	3.56
1.6 + 2.0 + 5.0	71.6 (22)	20439.06	0.88	20911.25	0.88	21068.64	0.88	21383.44	0.88	29538.82	1.42	34975.75	1.77
	77.0 (25)	23305.92	1.49	23913.02	1.46	24115.39	1.46	24520.12	1.44	30631.60	1.79	34705.92	2.02
	84.2 (29)	26105.33	2.14	26779.89	2.11	27004.74	2.10	27454.44	2.08	31380.36	2.23	33997.64	2.32
	89.6 (32)	27319.53	2.53	28061.54	2.49	28308.88	2.48	28803.55	2.46	35131.53	2.50	39350.19	2.53
	95.0 (35)	27791.72	2.81	28567.46	2.79	28826.04	2.78	29343.20	2.77	31144.27	2.73	32344.98	2.71
	104.0 (40)	27015.98	3.09	27791.72	3.10	28050.30	3.10	28567.46	3.11	27636.57	3.03	27015.98	2.97
	109.4 (43)	25531.96	3.09	26307.70	3.15	26566.28	3.17	27083.44	3.22	28196.45	3.15	28938.47	3.11
	114.8 (46)	23272.19	3.02	24047.93	3.13	24306.51	3.17	24823.67	3.24	26321.19	3.22	27319.53	3.22
1.6 + 2.0 + 7.0	71.6 (22)	20914.38	0.90	21397.55	0.90	21558.61	0.90	21880.72	0.90	30225.77	1.45	35789.13	1.82
	77.0 (25)	23847.92	1.52	24469.14	1.50	24676.21	1.49	25090.36	1.48	31343.97	1.83	35513.04	2.07
	84.2 (29)	26712.43	2.20	27402.67	2.17	27632.76	2.15	28092.92	2.13	32110.14	2.28	34788.28	2.38
	89.6 (32)	27954.87	2.59	28714.14	2.56	28967.23	2.55	29473.41	2.52	35948.55	2.56	40265.31	2.59
	95.0 (35)	28438.04	2.88	29231.82	2.86	29496.41	2.85	30025.60	2.84	31868.55	2.80	33097.18	2.77
	104.0 (40)	27644.26	3.17	28438.04	3.18	28702.63	3.18	29231.82	3.19	28279.28	3.10	27644.26	3.05
	109.4 (43)	26125.72	3.17	26919.50	3.23	27184.10	3.25	27713.28	3.30	28852.19	3.23	29611.45	3.19
	114.8 (46)	23813.41	3.10	24607.19	3.21	24871.78	3.25	25400.97	3.32	26933.31	3.31	27954.87	3.30
1.6 + 2.5 + 2.5	71.6 (22)	20201.39	1.00	20668.09	1.00	20823.66	1.00	21134.79	1.00	29195.35	1.61	34569.05	2.02
	77.0 (25)	23034.92	1.69	23634.96	1.67	23834.98	1.66	24235.00	1.64	30275.42	2.03	34302.37	2.29
	84.2 (29)	25801.78	2.44	26468.49	2.40	26690.73	2.39	27135.20	2.37	31015.47	2.53	33602.32	2.64
	89.6 (32)	27001.86	2.87	27735.25	2.84	27979.71	2.82	28468.63	2.80	34723.03	2.84	38892.63	2.87
	95.0 (35)	27468.56	3.20	28235.28	3.17	28490.85	3.17	29002.00	3.15	30782.12	3.11	31968.87	3.08
	104.0 (40)	26701.84	3.51	27468.56	3.52	27724.13	3.53	28235.28	3.54	27315.22	3.44	26701.84	3.38
	109.4 (43)	25235.07	3.51	26001.79	3.58	26257.37	3.61	26768.51	3.66	27868.59	3.58	28601.97	3.54
	114.8 (46)	23001.59	3.44	23768.31	3.56	24023.88	3.60	24535.03	3.68	26015.13	3.67	27001.86	3.66

Combination (Capacity)	Outdoor Air Temp. °F (°C) DB	Indoor Air Temp. °F (°C) WB											
		60.8 (16)		63.5 (17.5)		64.4 (18)		66.2 (19)		71.6 (22)		75.2 (24)	
		Total Capacity (BTU/h)	Input Power (kW)	Total Capacity (BTU/h)	Input Power (kW)	Total Capacity (BTU/h)	Input Power (kW)	Total Capacity (BTU/h)	Input Power (kW)	Total Capacity (BTU/h)	Input Power (kW)	Total Capacity (BTU/h)	Input Power (kW)
1.6 + 2.5 + 3.2	71.6 (22)	20201.39	0.98	20668.09	0.98	20823.66	0.98	21134.79	0.98	29195.35	1.57	34569.05	1.96
	77.0 (25)	23034.92	1.65	23634.96	1.62	23834.98	1.62	24235.00	1.60	30275.42	1.98	34302.37	2.23
	84.2 (29)	25801.78	2.38	26468.49	2.34	26690.73	2.33	27135.20	2.31	31015.47	2.47	33602.32	2.58
	89.6 (32)	27001.86	2.80	27735.25	2.76	27979.71	2.75	28468.63	2.73	34723.03	2.77	38892.63	2.80
	95.0 (35)	27468.56	3.12	28235.28	3.09	28490.85	3.09	29002.00	3.07	30782.12	3.03	31968.87	3.00
	104.0 (40)	26701.84	3.42	27468.56	3.43	27724.13	3.44	28235.28	3.45	27315.22	3.35	26701.84	3.29
	109.4 (43)	25235.07	3.42	26001.79	3.49	26257.37	3.52	26768.51	3.56	27868.59	3.49	28601.97	3.45
	114.8 (46)	23001.59	3.35	23768.31	3.47	24023.88	3.51	24535.03	3.59	26015.13	3.57	27001.86	3.56
1.6 + 2.5 + 5.0	71.6 (22)	20439.06	0.88	20911.25	0.88	21068.64	0.88	21383.44	0.88	29538.82	1.42	34975.75	1.77
	77.0 (25)	23305.92	1.49	23913.02	1.46	24115.39	1.46	24520.12	1.44	30631.60	1.79	34705.92	2.02
	84.2 (29)	26105.33	2.14	26779.89	2.11	27004.74	2.10	27454.44	2.08	31380.36	2.23	33997.64	2.32
	89.6 (32)	27319.53	2.53	28061.54	2.49	28308.88	2.48	28803.55	2.46	35131.53	2.50	39350.19	2.53
	95.0 (35)	27791.72	2.81	28567.46	2.79	28826.04	2.78	29343.20	2.77	31144.27	2.73	32344.98	2.71
	104.0 (40)	27015.98	3.09	27791.72	3.10	28050.30	3.10	28567.46	3.11	27636.57	3.03	27015.98	2.97
	109.4 (43)	25531.96	3.09	26307.70	3.15	26566.28	3.17	27083.44	3.22	28196.45	3.15	28938.47	3.11
	114.8 (46)	23272.19	3.02	24047.93	3.13	24306.51	3.17	24823.67	3.24	26321.19	3.22	27319.53	3.22
1.6 + 2.5 + 7.0	71.6 (22)	20914.38	0.90	21397.55	0.90	21558.61	0.90	21880.72	0.90	30225.77	1.45	35789.13	1.82
	77.0 (25)	23847.92	1.52	24469.14	1.50	24676.21	1.49	25090.36	1.48	31343.97	1.83	35513.04	2.07
	84.2 (29)	26712.43	2.20	27402.67	2.17	27632.76	2.15	28092.92	2.13	32110.14	2.28	34788.28	2.38
	89.6 (32)	27954.87	2.59	28714.14	2.56	28967.23	2.55	29473.41	2.52	35948.55	2.56	40265.31	2.59
	95.0 (35)	28438.04	2.88	29231.82	2.86	29496.41	2.85	30025.60	2.84	31868.55	2.80	33097.18	2.77
	104.0 (40)	27644.26	3.17	28438.04	3.18	28702.63	3.18	29231.82	3.19	28279.28	3.10	27644.26	3.05
	109.4 (43)	26125.72	3.17	26919.50	3.23	27184.10	3.25	27713.28	3.30	28852.19	3.23	29611.45	3.19
	114.8 (46)	23813.41	3.10	24607.19	3.21	24871.78	3.25	25400.97	3.32	26933.31	3.31	27954.87	3.30
1.6 + 3.2 + 3.2	71.6 (22)	20439.06	0.98	20911.25	0.98	21068.64	0.98	21383.44	0.98	29538.82	1.57	34975.75	1.96
	77.0 (25)	23305.92	1.65	23913.02	1.62	24115.39	1.62	24520.12	1.60	30631.60	1.98	34705.92	2.23
	84.2 (29)	26105.33	2.38	26779.89	2.34	27004.74	2.33	27454.44	2.31	31380.36	2.47	33997.64	2.58
	89.6 (32)	27319.53	2.80	28061.54	2.76	28308.88	2.75	28803.55	2.73	35131.53	2.77	39350.19	2.80
	95.0 (35)	27791.72	3.12	28567.46	3.09	28826.04	3.09	29343.20	3.07	31144.27	3.03	32344.98	3.00
	104.0 (40)	27015.98	3.42	27791.72	3.43	28050.30	3.44	28567.46	3.45	27636.57	3.35	27015.98	3.29
	109.4 (43)	25531.96	3.42	26307.70	3.49	26566.28	3.52	27083.44	3.56	28196.45	3.49	28938.47	3.45
	114.8 (46)	23272.19	3.35	24047.93	3.47	24306.51	3.51	24823.67	3.59	26321.19	3.57	27319.53	3.56

Combination (Capacity)	Outdoor Air Temp. °F (°C) DB	Indoor Air Temp. °F (°C) WB											
		60.8 (16)		63.5 (17.5)		64.4 (18)		66.2 (19)		71.6 (22)		75.2 (24)	
		Total Capacity (BTU/h)	Input Power (kW)	Total Capacity (BTU/h)	Input Power (kW)	Total Capacity (BTU/h)	Input Power (kW)	Total Capacity (BTU/h)	Input Power (kW)	Total Capacity (BTU/h)	Input Power (kW)	Total Capacity (BTU/h)	Input Power (kW)
1.6 + 3.2 + 5.0	71.6 (22)	20439.06	0.88	20911.25	0.88	21068.64	0.88	21383.44	0.88	29538.82	1.42	34975.75	1.77
	77.0 (25)	23305.92	1.49	23913.02	1.46	24115.39	1.46	24520.12	1.44	30631.60	1.79	34705.92	2.02
	84.2 (29)	26105.33	2.14	26779.89	2.11	27004.74	2.10	27454.44	2.08	31380.36	2.23	33997.64	2.32
	89.6 (32)	27319.53	2.53	28061.54	2.49	28308.88	2.48	28803.55	2.46	35131.53	2.50	39350.19	2.53
	95.0 (35)	27791.72	2.81	28567.46	2.79	28826.04	2.78	29343.20	2.77	31144.27	2.73	32344.98	2.71
	104.0 (40)	27015.98	3.09	27791.72	3.10	28050.30	3.10	28567.46	3.11	27636.57	3.03	27015.98	2.97
	109.4 (43)	25531.96	3.09	26307.70	3.15	26566.28	3.17	27083.44	3.22	28196.45	3.15	28938.47	3.11
	114.8 (46)	23272.19	3.02	24047.93	3.13	24306.51	3.17	24823.67	3.24	26321.19	3.22	27319.53	3.22
1.6 + 3.2 + 7.0	71.6 (22)	21389.71	0.93	21883.86	0.93	22048.58	0.93	22378.01	0.93	30912.72	1.49	36602.52	1.86
	77.0 (25)	24389.92	1.56	25025.26	1.54	25237.03	1.53	25660.59	1.52	32056.33	1.88	36320.15	2.12
	84.2 (29)	27319.53	2.25	28025.46	2.22	28260.77	2.21	28731.39	2.19	32839.91	2.34	35578.92	2.44
	89.6 (32)	28590.21	2.65	29366.73	2.62	29625.57	2.61	30143.26	2.59	36765.56	2.63	41180.43	2.65
	95.0 (35)	29084.36	2.95	29896.18	2.93	30166.79	2.92	30708.00	2.91	32592.84	2.87	33849.39	2.84
	104.0 (40)	28272.54	3.24	29084.36	3.26	29354.97	3.26	29896.18	3.27	28921.99	3.18	28272.54	3.12
	109.4 (43)	26719.49	3.24	27531.31	3.31	27801.92	3.33	28343.13	3.38	29507.92	3.31	30284.44	3.27
	114.8 (46)	24354.62	3.18	25166.44	3.29	25437.05	3.33	25978.26	3.40	27545.43	3.39	28590.21	3.38
1.6 + 5.0 + 5.0	71.6 (22)	20914.38	0.86	21397.55	0.86	21558.61	0.86	21880.72	0.86	30225.77	1.37	35789.13	1.72
	77.0 (25)	23847.92	1.44	24469.14	1.42	24676.21	1.42	25090.36	1.40	31343.97	1.74	35513.04	1.96
	84.2 (29)	26712.43	2.08	27402.67	2.05	27632.76	2.04	28092.92	2.02	32110.14	2.16	34788.28	2.26
	89.6 (32)	27954.87	2.45	28714.14	2.42	28967.23	2.41	29473.41	2.39	35948.55	2.43	40265.31	2.45
	95.0 (35)	28438.04	2.73	29231.82	2.71	29496.41	2.70	30025.60	2.69	31868.55	2.65	33097.18	2.63
	104.0 (40)	27644.26	3.00	28438.04	3.01	28702.63	3.01	29231.82	3.02	28279.28	2.94	27644.26	2.89
	109.4 (43)	26125.72	3.00	26919.50	3.06	27184.10	3.08	27713.28	3.12	28852.19	3.06	29611.45	3.02
	114.8 (46)	23813.41	2.94	24607.19	3.04	24871.78	3.07	25400.97	3.14	26933.31	3.13	27954.87	3.12
1.6 + 5.0 + 7.0	71.6 (22)	21389.71	0.88	21883.86	0.88	22048.58	0.88	22378.01	0.88	30912.72	1.42	36602.52	1.77
	77.0 (25)	24389.92	1.49	25025.26	1.46	25237.03	1.46	25660.59	1.44	32056.33	1.79	36320.15	2.02
	84.2 (29)	27319.53	2.14	28025.46	2.11	28260.77	2.10	28731.39	2.08	32839.91	2.23	35578.92	2.32
	89.6 (32)	28590.21	2.53	29366.73	2.49	29625.57	2.48	30143.26	2.46	36765.56	2.50	41180.43	2.53
	95.0 (35)	29084.36	2.81	29896.18	2.79	30166.79	2.78	30708.00	2.77	32592.84	2.73	33849.39	2.71
	104.0 (40)	28272.54	3.09	29084.36	3.10	29354.97	3.10	29896.18	3.11	28921.99	3.03	28272.54	2.97
	109.4 (43)	26719.49	3.09	27531.31	3.15	27801.92	3.17	28343.13	3.22	29507.92	3.15	30284.44	3.11
	114.8 (46)	24354.62	3.02	25166.44	3.13	25437.05	3.17	25978.26	3.24	27545.43	3.22	28590.21	3.22

Combination (Capacity)	Outdoor Air Temp. °F (°C) DB	Indoor Air Temp. °F (°C) WB											
		60.8 (16)		63.5 (17.5)		64.4 (18)		66.2 (19)		71.6 (22)		75.2 (24)	
		Total Capacity (BTU/h)	Input Power (kW)	Total Capacity (BTU/h)	Input Power (kW)	Total Capacity (BTU/h)	Input Power (kW)	Total Capacity (BTU/h)	Input Power (kW)	Total Capacity (BTU/h)	Input Power (kW)	Total Capacity (BTU/h)	Input Power (kW)
2.0 + 2.0 + 2.0	71.6 (22)	20201.39	1.00	20668.09	1.00	20823.66	1.00	21134.79	1.00	29195.35	1.61	34569.05	2.02
	77.0 (25)	23034.92	1.69	23634.96	1.67	23834.98	1.66	24235.00	1.64	30275.42	2.03	34302.37	2.29
	84.2 (29)	25801.78	2.44	26468.49	2.40	26690.73	2.39	27135.20	2.37	31015.47	2.53	33602.32	2.64
	89.6 (32)	27001.86	2.87	27735.25	2.84	27979.71	2.82	28468.63	2.80	34723.03	2.84	38892.63	2.87
	95.0 (35)	27468.56	3.20	28235.28	3.17	28490.85	3.17	29002.00	3.15	30782.12	3.11	31968.87	3.08
	104.0 (40)	26701.84	3.51	27468.56	3.52	27724.13	3.53	28235.28	3.54	27315.22	3.44	26701.84	3.38
	109.4 (43)	25235.07	3.51	26001.79	3.58	26257.37	3.61	26768.51	3.66	27868.59	3.58	28601.97	3.54
	114.8 (46)	23001.59	3.44	23768.31	3.56	24023.88	3.60	24535.03	3.68	26015.13	3.67	27001.86	3.66
2.0 + 2.0 + 2.5	71.6 (22)	20201.39	1.00	20668.09	1.00	20823.66	1.00	21134.79	1.00	29195.35	1.61	34569.05	2.02
	77.0 (25)	23034.92	1.69	23634.96	1.67	23834.98	1.66	24235.00	1.64	30275.42	2.03	34302.37	2.29
	84.2 (29)	25801.78	2.44	26468.49	2.40	26690.73	2.39	27135.20	2.37	31015.47	2.53	33602.32	2.64
	89.6 (32)	27001.86	2.87	27735.25	2.84	27979.71	2.82	28468.63	2.80	34723.03	2.84	38892.63	2.87
	95.0 (35)	27468.56	3.20	28235.28	3.17	28490.85	3.17	29002.00	3.15	30782.12	3.11	31968.87	3.08
	104.0 (40)	26701.84	3.51	27468.56	3.52	27724.13	3.53	28235.28	3.54	27315.22	3.44	26701.84	3.38
	109.4 (43)	25235.07	3.51	26001.79	3.58	26257.37	3.61	26768.51	3.66	27868.59	3.58	28601.97	3.54
	114.8 (46)	23001.59	3.44	23768.31	3.56	24023.88	3.60	24535.03	3.68	26015.13	3.67	27001.86	3.66
2.0 + 2.0 + 3.2	71.6 (22)	20201.39	0.98	20668.09	0.98	20823.66	0.98	21134.79	0.98	29195.35	1.57	34569.05	1.96
	77.0 (25)	23034.92	1.65	23634.96	1.62	23834.98	1.62	24235.00	1.60	30275.42	1.98	34302.37	2.23
	84.2 (29)	25801.78	2.38	26468.49	2.34	26690.73	2.33	27135.20	2.31	31015.47	2.47	33602.32	2.58
	89.6 (32)	27001.86	2.80	27735.25	2.76	27979.71	2.75	28468.63	2.73	34723.03	2.77	38892.63	2.80
	95.0 (35)	27468.56	3.12	28235.28	3.09	28490.85	3.09	29002.00	3.07	30782.12	3.03	31968.87	3.00
	104.0 (40)	26701.84	3.42	27468.56	3.43	27724.13	3.44	28235.28	3.45	27315.22	3.35	26701.84	3.29
	109.4 (43)	25235.07	3.42	26001.79	3.49	26257.37	3.52	26768.51	3.56	27868.59	3.49	28601.97	3.45
	114.8 (46)	23001.59	3.35	23768.31	3.47	24023.88	3.51	24535.03	3.59	26015.13	3.57	27001.86	3.56
2.0 + 2.0 + 5.0	71.6 (22)	20439.06	0.88	20911.25	0.88	21068.64	0.88	21383.44	0.88	29538.82	1.42	34975.75	1.77
	77.0 (25)	23305.92	1.49	23913.02	1.46	24115.39	1.46	24520.12	1.44	30631.60	1.79	34705.92	2.02
	84.2 (29)	26105.33	2.14	26779.89	2.11	27004.74	2.10	27454.44	2.08	31380.36	2.23	33997.64	2.32
	89.6 (32)	27319.53	2.53	28061.54	2.49	28308.88	2.48	28803.55	2.46	35131.53	2.50	39350.19	2.53
	95.0 (35)	27791.72	2.81	28567.46	2.79	28826.04	2.78	29343.20	2.77	31144.27	2.73	32344.98	2.71
	104.0 (40)	27015.98	3.09	27791.72	3.10	28050.30	3.10	28567.46	3.11	27636.57	3.03	27015.98	2.97
	109.4 (43)	25531.96	3.09	26307.70	3.15	26566.28	3.17	27083.44	3.22	28196.45	3.15	28938.47	3.11
	114.8 (46)	23272.19	3.02	24047.93	3.13	24306.51	3.17	24823.67	3.24	26321.19	3.22	27319.53	3.22

Combination (Capacity)	Outdoor Air Temp. °F (°C) DB	Indoor Air Temp. °F (°C) WB											
		60.8 (16)		63.5 (17.5)		64.4 (18)		66.2 (19)		71.6 (22)		75.2 (24)	
		Total Capacity (BTU/h)	Input Power (kW)	Total Capacity (BTU/h)	Input Power (kW)	Total Capacity (BTU/h)	Input Power (kW)	Total Capacity (BTU/h)	Input Power (kW)	Total Capacity (BTU/h)	Input Power (kW)	Total Capacity (BTU/h)	Input Power (kW)
2.0 + 2.0 + 7.0	71.6 (22)	20914.38	0.90	21397.55	0.90	21558.61	0.90	21880.72	0.90	30225.77	1.45	35789.13	1.82
	77.0 (25)	23847.92	1.52	24469.14	1.50	24676.21	1.49	25090.36	1.48	31343.97	1.83	35513.04	2.07
	84.2 (29)	26712.43	2.20	27402.67	2.17	27632.76	2.15	28092.92	2.13	32110.14	2.28	34788.28	2.38
	89.6 (32)	27954.87	2.59	28714.14	2.56	28967.23	2.55	29473.41	2.52	35948.55	2.56	40265.31	2.59
	95.0 (35)	28438.04	2.88	29231.82	2.86	29496.41	2.85	30025.60	2.84	31868.55	2.80	33097.18	2.77
	104.0 (40)	27644.26	3.17	28438.04	3.18	28702.63	3.18	29231.82	3.19	28279.28	3.10	27644.26	3.05
	109.4 (43)	26125.72	3.17	26919.50	3.23	27184.10	3.25	27713.28	3.30	28852.19	3.23	29611.45	3.19
	114.8 (46)	23813.41	3.10	24607.19	3.21	24871.78	3.25	25400.97	3.32	26933.31	3.31	27954.87	3.30
2.0 + 2.5 + 2.5	71.6 (22)	20201.39	1.00	20668.09	1.00	20823.66	1.00	21134.79	1.00	29195.35	1.61	34569.05	2.02
	77.0 (25)	23034.92	1.69	23634.96	1.67	23834.98	1.66	24235.00	1.64	30275.42	2.03	34302.37	2.29
	84.2 (29)	25801.78	2.44	26468.49	2.40	26690.73	2.39	27135.20	2.37	31015.47	2.53	33602.32	2.64
	89.6 (32)	27001.86	2.87	27735.25	2.84	27979.71	2.82	28468.63	2.80	34723.03	2.84	38892.63	2.87
	95.0 (35)	27468.56	3.20	28235.28	3.17	28490.85	3.17	29002.00	3.15	30782.12	3.11	31968.87	3.08
	104.0 (40)	26701.84	3.51	27468.56	3.52	27724.13	3.53	28235.28	3.54	27315.22	3.44	26701.84	3.38
	109.4 (43)	25235.07	3.51	26001.79	3.58	26257.37	3.61	26768.51	3.66	27868.59	3.58	28601.97	3.54
	114.8 (46)	23001.59	3.44	23768.31	3.56	24023.88	3.60	24535.03	3.68	26015.13	3.67	27001.86	3.66
2.0 + 2.5 + 3.2	71.6 (22)	20201.39	0.98	20668.09	0.98	20823.66	0.98	21134.79	0.98	29195.35	1.57	34569.05	1.96
	77.0 (25)	23034.92	1.65	23634.96	1.62	23834.98	1.62	24235.00	1.60	30275.42	1.98	34302.37	2.23
	84.2 (29)	25801.78	2.38	26468.49	2.34	26690.73	2.33	27135.20	2.31	31015.47	2.47	33602.32	2.58
	89.6 (32)	27001.86	2.80	27735.25	2.76	27979.71	2.75	28468.63	2.73	34723.03	2.77	38892.63	2.80
	95.0 (35)	27468.56	3.12	28235.28	3.09	28490.85	3.09	29002.00	3.07	30782.12	3.03	31968.87	3.00
	104.0 (40)	26701.84	3.42	27468.56	3.43	27724.13	3.44	28235.28	3.45	27315.22	3.35	26701.84	3.29
	109.4 (43)	25235.07	3.42	26001.79	3.49	26257.37	3.52	26768.51	3.56	27868.59	3.49	28601.97	3.45
	114.8 (46)	23001.59	3.35	23768.31	3.47	24023.88	3.51	24535.03	3.59	26015.13	3.57	27001.86	3.56
2.0 + 2.5 + 5.0	71.6 (22)	20439.06	0.88	20911.25	0.88	21068.64	0.88	21383.44	0.88	29538.82	1.42	34975.75	1.77
	77.0 (25)	23305.92	1.49	23913.02	1.46	24115.39	1.46	24520.12	1.44	30631.60	1.79	34705.92	2.02
	84.2 (29)	26105.33	2.14	26779.89	2.11	27004.74	2.10	27454.44	2.08	31380.36	2.23	33997.64	2.32
	89.6 (32)	27319.53	2.53	28061.54	2.49	28308.88	2.48	28803.55	2.46	35131.53	2.50	39350.19	2.53
	95.0 (35)	27791.72	2.81	28567.46	2.79	28826.04	2.78	29343.20	2.77	31144.27	2.73	32344.98	2.71
	104.0 (40)	27015.98	3.09	27791.72	3.10	28050.30	3.10	28567.46	3.11	27636.57	3.03	27015.98	2.97
	109.4 (43)	25531.96	3.09	26307.70	3.15	26566.28	3.17	27083.44	3.22	28196.45	3.15	28938.47	3.11
	114.8 (46)	23272.19	3.02	24047.93	3.13	24306.51	3.17	24823.67	3.24	26321.19	3.22	27319.53	3.22

Combination (Capacity)	Outdoor Air Temp. °F (°C) DB	Indoor Air Temp. °F (°C) WB											
		60.8 (16)		63.5 (17.5)		64.4 (18)		66.2 (19)		71.6 (22)		75.2 (24)	
		Total Capacity (BTU/h)	Input Power (kW)	Total Capacity (BTU/h)	Input Power (kW)	Total Capacity (BTU/h)	Input Power (kW)	Total Capacity (BTU/h)	Input Power (kW)	Total Capacity (BTU/h)	Input Power (kW)	Total Capacity (BTU/h)	Input Power (kW)
2.0 + 2.5 + 7.0	71.6 (22)	20914.38	0.90	21397.55	0.90	21558.61	0.90	21880.72	0.90	30225.77	1.45	35789.13	1.82
	77.0 (25)	23847.92	1.52	24469.14	1.50	24676.21	1.49	25090.36	1.48	31343.97	1.83	35513.04	2.07
	84.2 (29)	26712.43	2.20	27402.67	2.17	27632.76	2.15	28092.92	2.13	32110.14	2.28	34788.28	2.38
	89.6 (32)	27954.87	2.59	28714.14	2.56	28967.23	2.55	29473.41	2.52	35948.55	2.56	40265.31	2.59
	95.0 (35)	28438.04	2.88	29231.82	2.86	29496.41	2.85	30025.60	2.84	31868.55	2.80	33097.18	2.77
	104.0 (40)	27644.26	3.17	28438.04	3.18	28702.63	3.18	29231.82	3.19	28279.28	3.10	27644.26	3.05
	109.4 (43)	26125.72	3.17	26919.50	3.23	27184.10	3.25	27713.28	3.30	28852.19	3.23	29611.45	3.19
	114.8 (46)	23813.41	3.10	24607.19	3.21	24871.78	3.25	25400.97	3.32	26933.31	3.31	27954.87	3.30
2.0 + 3.2 + 3.2	71.6 (22)	20439.06	0.98	20911.25	0.98	21068.64	0.98	21383.44	0.98	29538.82	1.57	34975.75	1.96
	77.0 (25)	23305.92	1.65	23913.02	1.62	24115.39	1.62	24520.12	1.60	30631.60	1.98	34705.92	2.23
	84.2 (29)	26105.33	2.38	26779.89	2.34	27004.74	2.33	27454.44	2.31	31380.36	2.47	33997.64	2.58
	89.6 (32)	27319.53	2.80	28061.54	2.76	28308.88	2.75	28803.55	2.73	35131.53	2.77	39350.19	2.80
	95.0 (35)	27791.72	3.12	28567.46	3.09	28826.04	3.09	29343.20	3.07	31144.27	3.03	32344.98	3.00
	104.0 (40)	27015.98	3.42	27791.72	3.43	28050.30	3.44	28567.46	3.45	27636.57	3.35	27015.98	3.29
	109.4 (43)	25531.96	3.42	26307.70	3.49	26566.28	3.52	27083.44	3.56	28196.45	3.49	28938.47	3.45
	114.8 (46)	23272.19	3.35	24047.93	3.47	24306.51	3.51	24823.67	3.59	26321.19	3.57	27319.53	3.56
2.0 + 3.2 + 5.0	71.6 (22)	20914.38	0.90	21397.55	0.90	21558.61	0.90	21880.72	0.90	30225.77	1.45	35789.13	1.82
	77.0 (25)	23847.92	1.52	24469.14	1.50	24676.21	1.49	25090.36	1.48	31343.97	1.83	35513.04	2.07
	84.2 (29)	26712.43	2.20	27402.67	2.17	27632.76	2.15	28092.92	2.13	32110.14	2.28	34788.28	2.38
	89.6 (32)	27954.87	2.59	28714.14	2.56	28967.23	2.55	29473.41	2.52	35948.55	2.56	40265.31	2.59
	95.0 (35)	28438.04	2.88	29231.82	2.86	29496.41	2.85	30025.60	2.84	31868.55	2.80	33097.18	2.77
	104.0 (40)	27644.26	3.17	28438.04	3.18	28702.63	3.18	29231.82	3.19	28279.28	3.10	27644.26	3.05
	109.4 (43)	26125.72	3.17	26919.50	3.23	27184.10	3.25	27713.28	3.30	28852.19	3.23	29611.45	3.19
	114.8 (46)	23813.41	3.10	24607.19	3.21	24871.78	3.25	25400.97	3.32	26933.31	3.31	27954.87	3.30
2.0 + 3.2 + 7.0	71.6 (22)	21389.71	0.93	21883.86	0.93	22048.58	0.93	22378.01	0.93	30912.72	1.49	36602.52	1.86
	77.0 (25)	24389.92	1.56	25025.26	1.54	25237.03	1.53	25660.59	1.52	32056.33	1.88	36320.15	2.12
	84.2 (29)	27319.53	2.25	28025.46	2.22	28260.77	2.21	28731.39	2.19	32839.91	2.34	35578.92	2.44
	89.6 (32)	28590.21	2.65	29366.73	2.62	29625.57	2.61	30143.26	2.59	36765.56	2.63	41180.43	2.65
	95.0 (35)	29084.36	2.95	29896.18	2.93	30166.79	2.92	30708.00	2.91	32592.84	2.87	33849.39	2.84
	104.0 (40)	28272.54	3.24	29084.36	3.26	29354.97	3.26	29896.18	3.27	28921.99	3.18	28272.54	3.12
	109.4 (43)	26719.49	3.24	27531.31	3.31	27801.92	3.33	28343.13	3.38	29507.92	3.31	30284.44	3.27
	114.8 (46)	24354.62	3.18	25166.44	3.29	25437.05	3.33	25978.26	3.40	27545.43	3.39	28590.21	3.38

Combination (Capacity)	Outdoor Air Temp. °F (°C) DB	Indoor Air Temp. °F (°C) WB											
		60.8 (16)		63.5 (17.5)		64.4 (18)		66.2 (19)		71.6 (22)		75.2 (24)	
		Total Capacity (BTU/h)	Input Power (kW)	Total Capacity (BTU/h)	Input Power (kW)	Total Capacity (BTU/h)	Input Power (kW)	Total Capacity (BTU/h)	Input Power (kW)	Total Capacity (BTU/h)	Input Power (kW)	Total Capacity (BTU/h)	Input Power (kW)
2.0 + 5.0 + 5.0	71.6 (22)	21389.71	0.88	21883.86	0.88	22048.58	0.88	22378.01	0.88	30912.72	1.42	36602.52	1.77
	77.0 (25)	24389.92	1.49	25025.26	1.46	25237.03	1.46	25660.59	1.44	32056.33	1.79	36320.15	2.02
	84.2 (29)	27319.53	2.14	28025.46	2.11	28260.77	2.10	28731.39	2.08	32839.91	2.23	35578.92	2.32
	89.6 (32)	28590.21	2.53	29366.73	2.49	29625.57	2.48	30143.26	2.46	36765.56	2.50	41180.43	2.53
	95.0 (35)	29084.36	2.81	29896.18	2.79	30166.79	2.78	30708.00	2.77	32592.84	2.73	33849.39	2.71
	104.0 (40)	28272.54	3.09	29084.36	3.10	29354.97	3.10	29896.18	3.11	28921.99	3.03	28272.54	2.97
	109.4 (43)	26719.49	3.09	27531.31	3.15	27801.92	3.17	28343.13	3.22	29507.92	3.15	30284.44	3.11
	114.8 (46)	24354.62	3.02	25166.44	3.13	25437.05	3.17	25978.26	3.24	27545.43	3.22	28590.21	3.22
2.5 + 2.5 + 2.5	71.6 (22)	20201.39	1.00	20668.09	1.00	20823.66	1.00	21134.79	1.00	29195.35	1.61	34569.05	2.02
	77.0 (25)	23034.92	1.69	23634.96	1.67	23834.98	1.66	24235.00	1.64	30275.42	2.03	34302.37	2.29
	84.2 (29)	25801.78	2.44	26468.49	2.40	26690.73	2.39	27135.20	2.37	31015.47	2.53	33602.32	2.64
	89.6 (32)	27001.86	2.87	27735.25	2.84	27979.71	2.82	28468.63	2.80	34723.03	2.84	38892.63	2.87
	95.0 (35)	27468.56	3.20	28235.28	3.17	28490.85	3.17	29002.00	3.15	30782.12	3.11	31968.87	3.08
	104.0 (40)	26701.84	3.51	27468.56	3.52	27724.13	3.53	28235.28	3.54	27315.22	3.44	26701.84	3.38
	109.4 (43)	25235.07	3.51	26001.79	3.58	26257.37	3.61	26768.51	3.66	27868.59	3.58	28601.97	3.54
	114.8 (46)	23001.59	3.44	23768.31	3.56	24023.88	3.60	24535.03	3.68	26015.13	3.67	27001.86	3.66
2.5 + 2.5 + 3.2	71.6 (22)	20439.06	1.00	20911.25	1.00	21068.64	1.00	21383.44	1.00	29538.82	1.61	34975.75	2.02
	77.0 (25)	23305.92	1.69	23913.02	1.67	24115.39	1.66	24520.12	1.64	30631.60	2.03	34705.92	2.29
	84.2 (29)	26105.33	2.44	26779.89	2.40	27004.74	2.39	27454.44	2.37	31380.36	2.53	33997.64	2.64
	89.6 (32)	27319.53	2.87	28061.54	2.84	28308.88	2.82	28803.55	2.80	35131.53	2.84	39350.19	2.87
	95.0 (35)	27791.72	3.20	28567.46	3.17	28826.04	3.17	29343.20	3.15	31144.27	3.11	32344.98	3.08
	104.0 (40)	27015.98	3.51	27791.72	3.52	28050.30	3.53	28567.46	3.54	27636.57	3.44	27015.98	3.38
	109.4 (43)	25531.96	3.51	26307.70	3.58	26566.28	3.61	27083.44	3.66	28196.45	3.58	28938.47	3.54
	114.8 (46)	23272.19	3.44	24047.93	3.56	24306.51	3.60	24823.67	3.68	26321.19	3.67	27319.53	3.66
2.5 + 2.5 + 5.0	71.6 (22)	20914.38	0.93	21397.55	0.93	21558.61	0.93	21880.72	0.93	30225.77	1.49	35789.13	1.86
	77.0 (25)	23847.92	1.56	24469.14	1.54	24676.21	1.53	25090.36	1.52	31343.97	1.88	35513.04	2.12
	84.2 (29)	26712.43	2.25	27402.67	2.22	27632.76	2.21	28092.92	2.19	32110.14	2.34	34788.28	2.44
	89.6 (32)	27954.87	2.65	28714.14	2.62	28967.23	2.61	29473.41	2.59	35948.55	2.63	40265.31	2.65
	95.0 (35)	28438.04	2.95	29231.82	2.93	29496.41	2.92	30025.60	2.91	31868.55	2.87	33097.18	2.84
	104.0 (40)	27644.26	3.24	28438.04	3.26	28702.63	3.26	29231.82	3.27	28279.28	3.18	27644.26	3.12
	109.4 (43)	26125.72	3.24	26919.50	3.31	27184.10	3.33	27713.28	3.38	28852.19	3.31	29611.45	3.27
	114.8 (46)	23813.41	3.18	24607.19	3.29	24871.78	3.33	25400.97	3.40	26933.31	3.39	27954.87	3.38

Combination (Capacity)	Outdoor Air Temp. °F (°C) DB	Indoor Air Temp. °F (°C) WB											
		60.8 (16)		63.5 (17.5)		64.4 (18)		66.2 (19)		71.6 (22)		75.2 (24)	
		Total Capacity (BTU/h)	Input Power (kW)	Total Capacity (BTU/h)	Input Power (kW)	Total Capacity (BTU/h)	Input Power (kW)	Total Capacity (BTU/h)	Input Power (kW)	Total Capacity (BTU/h)	Input Power (kW)	Total Capacity (BTU/h)	Input Power (kW)
2.5 + 2.5 + 7.0	71.6 (22)	21389.71	0.95	21883.86	0.95	22048.58	0.95	22378.01	0.95	30912.72	1.53	36602.52	1.91
	77.0 (25)	24389.92	1.60	25025.26	1.58	25237.03	1.57	25660.59	1.56	32056.33	1.93	36320.15	2.18
	84.2 (29)	27319.53	2.31	28025.46	2.28	28260.77	2.27	28731.39	2.25	32839.91	2.40	35578.92	2.51
	89.6 (32)	28590.21	2.73	29366.73	2.69	29625.57	2.68	30143.26	2.66	36765.56	2.70	41180.43	2.73
	95.0 (35)	29084.36	3.04	29896.18	3.01	30166.79	3.01	30708.00	2.99	32592.84	2.95	33849.39	2.92
	104.0 (40)	28272.54	3.33	29084.36	3.35	29354.97	3.35	29896.18	3.36	28921.99	3.27	28272.54	3.21
	109.4 (43)	26719.49	3.33	27531.31	3.40	27801.92	3.43	28343.13	3.47	29507.92	3.40	30284.44	3.36
	114.8 (46)	24354.62	3.26	25166.44	3.38	25437.05	3.42	25978.26	3.49	27545.43	3.48	28590.21	3.47
2.5 + 3.2 + 3.2	71.6 (22)	20439.06	0.98	20911.25	0.98	21068.64	0.98	21383.44	0.98	29538.82	1.57	34975.75	1.96
	77.0 (25)	23305.92	1.65	23913.02	1.62	24115.39	1.62	24520.12	1.60	30631.60	1.98	34705.92	2.23
	84.2 (29)	26105.33	2.38	26779.89	2.34	27004.74	2.33	27454.44	2.31	31380.36	2.47	33997.64	2.58
	89.6 (32)	27319.53	2.80	28061.54	2.76	28308.88	2.75	28803.55	2.73	35131.53	2.77	39350.19	2.80
	95.0 (35)	27791.72	3.12	28567.46	3.09	28826.04	3.09	29343.20	3.07	31144.27	3.03	32344.98	3.00
	104.0 (40)	27015.98	3.42	27791.72	3.43	28050.30	3.44	28567.46	3.45	27636.57	3.35	27015.98	3.29
	109.4 (43)	25531.96	3.42	26307.70	3.49	26566.28	3.52	27083.44	3.56	28196.45	3.49	28938.47	3.45
	114.8 (46)	23272.19	3.35	24047.93	3.47	24306.51	3.51	24823.67	3.59	26321.19	3.57	27319.53	3.56
2.5 + 3.2 + 5.0	71.6 (22)	20914.38	0.90	21397.55	0.90	21558.61	0.90	21880.72	0.90	30225.77	1.45	35789.13	1.82
	77.0 (25)	23847.92	1.52	24469.14	1.50	24676.21	1.49	25090.36	1.48	31343.97	1.83	35513.04	2.07
	84.2 (29)	26712.43	2.20	27402.67	2.17	27632.76	2.15	28092.92	2.13	32110.14	2.28	34788.28	2.38
	89.6 (32)	27954.87	2.59	28714.14	2.56	28967.23	2.55	29473.41	2.52	35948.55	2.56	40265.31	2.59
	95.0 (35)	28438.04	2.88	29231.82	2.86	29496.41	2.85	30025.60	2.84	31868.55	2.80	33097.18	2.77
	104.0 (40)	27644.26	3.17	28438.04	3.18	28702.63	3.18	29231.82	3.19	28279.28	3.10	27644.26	3.05
	109.4 (43)	26125.72	3.17	26919.50	3.23	27184.10	3.25	27713.28	3.30	28852.19	3.23	29611.45	3.19
	114.8 (46)	23813.41	3.10	24607.19	3.21	24871.78	3.25	25400.97	3.32	26933.31	3.31	27954.87	3.30
2.5 + 3.2 + 7.0	71.6 (22)	21389.71	0.93	21883.86	0.93	22048.58	0.93	22378.01	0.93	30912.72	1.49	36602.52	1.86
	77.0 (25)	24389.92	1.56	25025.26	1.54	25237.03	1.53	25660.59	1.52	32056.33	1.88	36320.15	2.12
	84.2 (29)	27319.53	2.25	28025.46	2.22	28260.77	2.21	28731.39	2.19	32839.91	2.34	35578.92	2.44
	89.6 (32)	28590.21	2.65	29366.73	2.62	29625.57	2.61	30143.26	2.59	36765.56	2.63	41180.43	2.65
	95.0 (35)	29084.36	2.95	29896.18	2.93	30166.79	2.92	30708.00	2.91	32592.84	2.87	33849.39	2.84
	104.0 (40)	28272.54	3.24	29084.36	3.26	29354.97	3.26	29896.18	3.27	28921.99	3.18	28272.54	3.12
	109.4 (43)	26719.49	3.24	27531.31	3.31	27801.92	3.33	28343.13	3.38	29507.92	3.31	30284.44	3.27
	114.8 (46)	24354.62	3.18	25166.44	3.29	25437.05	3.33	25978.26	3.40	27545.43	3.39	28590.21	3.38

Combination (Capacity)	Outdoor Air Temp. °F (°C) DB	Indoor Air Temp. °F (°C) WB											
		60.8 (16)		63.5 (17.5)		64.4 (18)		66.2 (19)		71.6 (22)		75.2 (24)	
		Total Capacity (BTU/h)	Input Power (kW)	Total Capacity (BTU/h)	Input Power (kW)	Total Capacity (BTU/h)	Input Power (kW)	Total Capacity (BTU/h)	Input Power (kW)	Total Capacity (BTU/h)	Input Power (kW)	Total Capacity (BTU/h)	Input Power (kW)
2.5 + 5.0 + 5.0	71.6 (22)	21389.71	0.88	21883.86	0.88	22048.58	0.88	22378.01	0.88	30912.72	1.42	36602.52	1.77
	77.0 (25)	24389.92	1.49	25025.26	1.46	25237.03	1.46	25660.59	1.44	32056.33	1.79	36320.15	2.02
	84.2 (29)	27319.53	2.14	28025.46	2.11	28260.77	2.10	28731.39	2.08	32839.91	2.23	35578.92	2.32
	89.6 (32)	28590.21	2.53	29366.73	2.49	29625.57	2.48	30143.26	2.46	36765.56	2.50	41180.43	2.53
	95.0 (35)	29084.36	2.81	29896.18	2.79	30166.79	2.78	30708.00	2.77	32592.84	2.73	33849.39	2.71
	104.0 (40)	28272.54	3.09	29084.36	3.10	29354.97	3.10	29896.18	3.11	28921.99	3.03	28272.54	2.97
	109.4 (43)	26719.49	3.09	27531.31	3.15	27801.92	3.17	28343.13	3.22	29507.92	3.15	30284.44	3.11
	114.8 (46)	24354.62	3.02	25166.44	3.13	25437.05	3.17	25978.26	3.24	27545.43	3.22	28590.21	3.22
3.2 + 3.2 + 3.2	71.6 (22)	20439.06	0.95	20911.25	0.95	21068.64	0.95	21383.44	0.95	29538.82	1.53	34975.75	1.91
	77.0 (25)	23305.92	1.60	23913.02	1.58	24115.39	1.57	24520.12	1.56	30631.60	1.93	34705.92	2.18
	84.2 (29)	26105.33	2.31	26779.89	2.28	27004.74	2.27	27454.44	2.25	31380.36	2.40	33997.64	2.51
	89.6 (32)	27319.53	2.73	28061.54	2.69	28308.88	2.68	28803.55	2.66	35131.53	2.70	39350.19	2.73
	95.0 (35)	27791.72	3.04	28567.46	3.01	28826.04	3.01	29343.20	2.99	31144.27	2.95	32344.98	2.92
	104.0 (40)	27015.98	3.33	27791.72	3.35	28050.30	3.35	28567.46	3.36	27636.57	3.27	27015.98	3.21
	109.4 (43)	25531.96	3.33	26307.70	3.40	26566.28	3.43	27083.44	3.47	28196.45	3.40	28938.47	3.36
	114.8 (46)	23272.19	3.26	24047.93	3.38	24306.51	3.42	24823.67	3.49	26321.19	3.48	27319.53	3.47
3.2 + 3.2 + 5.0	71.6 (22)	20914.38	0.90	21397.55	0.90	21558.61	0.90	21880.72	0.90	30225.77	1.45	35789.13	1.82
	77.0 (25)	23847.92	1.52	24469.14	1.50	24676.21	1.49	25090.36	1.48	31343.97	1.83	35513.04	2.07
	84.2 (29)	26712.43	2.20	27402.67	2.17	27632.76	2.15	28092.92	2.13	32110.14	2.28	34788.28	2.38
	89.6 (32)	27954.87	2.59	28714.14	2.56	28967.23	2.55	29473.41	2.52	35948.55	2.56	40265.31	2.59
	95.0 (35)	28438.04	2.88	29231.82	2.86	29496.41	2.85	30025.60	2.84	31868.55	2.80	33097.18	2.77
	104.0 (40)	27644.26	3.17	28438.04	3.18	28702.63	3.18	29231.82	3.19	28279.28	3.10	27644.26	3.05
	109.4 (43)	26125.72	3.17	26919.50	3.23	27184.10	3.25	27713.28	3.30	28852.19	3.23	29611.45	3.19
	114.8 (46)	23813.41	3.10	24607.19	3.21	24871.78	3.25	25400.97	3.32	26933.31	3.31	27954.87	3.30
3.2 + 3.2 + 7.0	71.6 (22)	21389.71	0.93	21883.86	0.93	22048.58	0.93	22378.01	0.93	30912.72	1.49	36602.52	1.86
	77.0 (25)	24389.92	1.56	25025.26	1.54	25237.03	1.53	25660.59	1.52	32056.33	1.88	36320.15	2.12
	84.2 (29)	27319.53	2.25	28025.46	2.22	28260.77	2.21	28731.39	2.19	32839.91	2.34	35578.92	2.44
	89.6 (32)	28590.21	2.65	29366.73	2.62	29625.57	2.61	30143.26	2.59	36765.56	2.63	41180.43	2.65
	95.0 (35)	29084.36	2.95	29896.18	2.93	30166.79	2.92	30708.00	2.91	32592.84	2.87	33849.39	2.84
	104.0 (40)	28272.54	3.24	29084.36	3.26	29354.97	3.26	29896.18	3.27	28921.99	3.18	28272.54	3.12
	109.4 (43)	26719.49	3.24	27531.31	3.31	27801.92	3.33	28343.13	3.38	29507.92	3.31	30284.44	3.27
	114.8 (46)	24354.62	3.18	25166.44	3.29	25437.05	3.33	25978.26	3.40	27545.43	3.39	28590.21	3.38

Combination (Capacity)	Outdoor Air Temp. °F (°C) DB	Indoor Air Temp. °F (°C) WB											
		60.8 (16)		63.5 (17.5)		64.4 (18)		66.2 (19)		71.6 (22)		75.2 (24)	
		Total Capacity (BTU/h)	Input Power (kW)	Total Capacity (BTU/h)	Input Power (kW)	Total Capacity (BTU/h)	Input Power (kW)	Total Capacity (BTU/h)	Input Power (kW)	Total Capacity (BTU/h)	Input Power (kW)	Total Capacity (BTU/h)	Input Power (kW)
3.2 + 5.0 + 5.0	71.6 (22)	21389.71	0.88	21883.86	0.88	22048.58	0.88	22378.01	0.88	30912.72	1.42	36602.52	1.77
	77.0 (25)	24389.92	1.49	25025.26	1.46	25237.03	1.46	25660.59	1.44	32056.33	1.79	36320.15	2.02
	84.2 (29)	27319.53	2.14	28025.46	2.11	28260.77	2.10	28731.39	2.08	32839.91	2.23	35578.92	2.32
	89.6 (32)	28590.21	2.53	29366.73	2.49	29625.57	2.48	30143.26	2.46	36765.56	2.50	41180.43	2.53
	95.0 (35)	29084.36	2.81	29896.18	2.79	30166.79	2.78	30708.00	2.77	32592.84	2.73	33849.39	2.71
	104.0 (40)	28272.54	3.09	29084.36	3.10	29354.97	3.10	29896.18	3.11	28921.99	3.03	28272.54	2.97
	109.4 (43)	26719.49	3.09	27531.31	3.15	27801.92	3.17	28343.13	3.22	29507.92	3.15	30284.44	3.11
	114.8 (46)	24354.62	3.02	25166.44	3.13	25437.05	3.17	25978.26	3.24	27545.43	3.22	28590.21	3.22
1.6 + 1.6 + 1.6 + 1.6	71.6 (22)	30465.10	1.35	27689.20	1.41	26763.89	1.43	24913.29	1.47	31177.41	1.72	35353.48	1.88
	77.0 (25)	30726.98	1.87	29103.34	1.90	28562.12	1.91	27479.69	1.93	32078.27	2.09	35143.98	2.19
	84.2 (29)	31215.81	2.43	30552.39	2.43	30331.25	2.43	29888.97	2.43	32738.20	2.50	34637.68	2.54
	89.6 (32)	30692.06	2.75	30831.73	2.73	30878.28	2.73	30971.40	2.72	32877.87	2.74	34148.84	2.75
	95.0 (35)	30342.89	2.98	30866.64	2.96	31041.23	2.95	31390.40	2.94	32668.36	2.92	33520.34	2.91
	104.0 (40)	29365.21	3.16	30028.64	3.16	30249.78	3.15	30692.06	3.15	30566.36	3.11	30482.56	3.09
	109.4 (43)	28457.37	3.15	28946.21	3.17	29109.15	3.17	29435.05	3.18	30545.41	3.16	31285.65	3.14
	114.8 (46)	27374.94	3.05	27462.24	3.10	27491.33	3.11	27549.53	3.14	29162.69	3.14	30238.14	3.14
1.6 + 1.6 + 1.6 + 2.0	71.6 (22)	30465.10	1.32	27689.20	1.37	26763.89	1.39	24913.29	1.43	31177.41	1.68	35353.48	1.84
	77.0 (25)	30726.98	1.83	29103.34	1.85	28562.12	1.86	27479.69	1.88	32078.27	2.04	35143.98	2.14
	84.2 (29)	31215.81	2.37	30552.39	2.37	30331.25	2.37	29888.97	2.37	32738.20	2.44	34637.68	2.48
	89.6 (32)	30692.06	2.68	30831.73	2.67	30878.28	2.66	30971.40	2.65	32877.87	2.67	34148.84	2.69
	95.0 (35)	30342.89	2.91	30866.64	2.89	31041.23	2.88	31390.40	2.87	32668.36	2.85	33520.34	2.84
	104.0 (40)	29365.21	3.09	30028.64	3.08	30249.78	3.08	30692.06	3.08	30566.36	3.04	30482.56	3.01
	109.4 (43)	28457.37	3.07	28946.21	3.09	29109.15	3.10	29435.05	3.11	30545.41	3.08	31285.65	3.06
	114.8 (46)	27374.94	2.98	27462.24	3.02	27491.33	3.04	27549.53	3.07	29162.69	3.06	30238.14	3.06
1.6 + 1.6 + 1.6 + 2.5	71.6 (22)	30465.10	1.32	27689.20	1.37	26763.89	1.39	24913.29	1.43	31177.41	1.68	35353.48	1.84
	77.0 (25)	30726.98	1.83	29103.34	1.85	28562.12	1.86	27479.69	1.88	32078.27	2.04	35143.98	2.14
	84.2 (29)	31215.81	2.37	30552.39	2.37	30331.25	2.37	29888.97	2.37	32738.20	2.44	34637.68	2.48
	89.6 (32)	30692.06	2.68	30831.73	2.67	30878.28	2.66	30971.40	2.65	32877.87	2.67	34148.84	2.69
	95.0 (35)	30342.89	2.91	30866.64	2.89	31041.23	2.88	31390.40	2.87	32668.36	2.85	33520.34	2.84
	104.0 (40)	29365.21	3.09	30028.64	3.08	30249.78	3.08	30692.06	3.08	30566.36	3.04	30482.56	3.01
	109.4 (43)	28457.37	3.07	28946.21	3.09	29109.15	3.10	29435.05	3.11	30545.41	3.08	31285.65	3.06
	114.8 (46)	27374.94	2.98	27462.24	3.02	27491.33	3.04	27549.53	3.07	29162.69	3.06	30238.14	3.06

Combination (Capacity)	Outdoor Air Temp. °F (°C) DB	Indoor Air Temp. °F (°C) WB											
		60.8 (16)		63.5 (17.5)		64.4 (18)		66.2 (19)		71.6 (22)		75.2 (24)	
		Total Capacity (BTU/h)	Input Power (kW)	Total Capacity (BTU/h)	Input Power (kW)	Total Capacity (BTU/h)	Input Power (kW)	Total Capacity (BTU/h)	Input Power (kW)	Total Capacity (BTU/h)	Input Power (kW)	Total Capacity (BTU/h)	Input Power (kW)
1.6 + 1.6 + 1.6 + 3.2	71.6 (22)	30465.10	1.32	27689.20	1.37	26763.89	1.39	24913.29	1.43	31177.41	1.68	35353.48	1.84
	77.0 (25)	30726.98	1.83	29103.34	1.85	28562.12	1.86	27479.69	1.88	32078.27	2.04	35143.98	2.14
	84.2 (29)	31215.81	2.37	30552.39	2.37	30331.25	2.37	29888.97	2.37	32738.20	2.44	34637.68	2.48
	89.6 (32)	30692.06	2.68	30831.73	2.67	30878.28	2.66	30971.40	2.65	32877.87	2.67	34148.84	2.69
	95.0 (35)	30342.89	2.91	30866.64	2.89	31041.23	2.88	31390.40	2.87	32668.36	2.85	33520.34	2.84
	104.0 (40)	29365.21	3.09	30028.64	3.08	30249.78	3.08	30692.06	3.08	30566.36	3.04	30482.56	3.01
	109.4 (43)	28457.37	3.07	28946.21	3.09	29109.15	3.10	29435.05	3.11	30545.41	3.08	31285.65	3.06
	114.8 (46)	27374.94	2.98	27462.24	3.02	27491.33	3.04	27549.53	3.07	29162.69	3.06	30238.14	3.06
1.6 + 1.6 + 1.6 + 5.0	71.6 (22)	30465.10	1.22	27689.20	1.27	26763.89	1.29	24913.29	1.33	31177.41	1.55	35353.48	1.70
	77.0 (25)	30726.98	1.69	29103.34	1.72	28562.12	1.73	27479.69	1.74	32078.27	1.89	35143.98	1.98
	84.2 (29)	31215.81	2.20	30552.39	2.20	30331.25	2.20	29888.97	2.20	32738.20	2.26	34637.68	2.30
	89.6 (32)	30692.06	2.49	30831.73	2.47	30878.28	2.47	30971.40	2.46	32877.87	2.48	34148.84	2.49
	95.0 (35)	30342.89	2.69	30866.64	2.68	31041.23	2.67	31390.40	2.66	32668.36	2.65	33520.34	2.64
	104.0 (40)	29365.21	2.86	30028.64	2.86	30249.78	2.85	30692.06	2.85	30566.36	2.82	30482.56	2.79
	109.4 (43)	28457.37	2.85	28946.21	2.86	29109.15	2.87	29435.05	2.88	30545.41	2.86	31285.65	2.84
	114.8 (46)	27374.94	2.76	27462.24	2.80	27491.33	2.82	27549.53	2.84	29162.69	2.84	30238.14	2.84
1.6 + 1.6 + 1.6 + 7.0	71.6 (22)	30465.10	1.22	27689.20	1.27	26763.89	1.29	24913.29	1.33	31177.41	1.55	35353.48	1.70
	77.0 (25)	30726.98	1.69	29103.34	1.72	28562.12	1.73	27479.69	1.74	32078.27	1.89	35143.98	1.98
	84.2 (29)	31215.81	2.20	30552.39	2.20	30331.25	2.20	29888.97	2.20	32738.20	2.26	34637.68	2.30
	89.6 (32)	30692.06	2.49	30831.73	2.47	30878.28	2.47	30971.40	2.46	32877.87	2.48	34148.84	2.49
	95.0 (35)	30342.89	2.69	30866.64	2.68	31041.23	2.67	31390.40	2.66	32668.36	2.65	33520.34	2.64
	104.0 (40)	29365.21	2.86	30028.64	2.86	30249.78	2.85	30692.06	2.85	30566.36	2.82	30482.56	2.79
	109.4 (43)	28457.37	2.85	28946.21	2.86	29109.15	2.87	29435.05	2.88	30545.41	2.86	31285.65	2.84
	114.8 (46)	27374.94	2.76	27462.24	2.80	27491.33	2.82	27549.53	2.84	29162.69	2.84	30238.14	2.84
1.6 + 1.6 + 2.0 + 2.0	71.6 (22)	30465.10	1.32	27689.20	1.37	26763.89	1.39	24913.29	1.43	31177.41	1.68	35353.48	1.84
	77.0 (25)	30726.98	1.83	29103.34	1.85	28562.12	1.86	27479.69	1.88	32078.27	2.04	35143.98	2.14
	84.2 (29)	31215.81	2.37	30552.39	2.37	30331.25	2.37	29888.97	2.37	32738.20	2.44	34637.68	2.48
	89.6 (32)	30692.06	2.68	30831.73	2.67	30878.28	2.66	30971.40	2.65	32877.87	2.67	34148.84	2.69
	95.0 (35)	30342.89	2.91	30866.64	2.89	31041.23	2.88	31390.40	2.87	32668.36	2.85	33520.34	2.84
	104.0 (40)	29365.21	3.09	30028.64	3.08	30249.78	3.08	30692.06	3.08	30566.36	3.04	30482.56	3.01
	109.4 (43)	28457.37	3.07	28946.21	3.09	29109.15	3.10	29435.05	3.11	30545.41	3.08	31285.65	3.06
	114.8 (46)	27374.94	2.98	27462.24	3.02	27491.33	3.04	27549.53	3.07	29162.69	3.06	30238.14	3.06

Combination (Capacity)	Outdoor Air Temp. °F (°C) DB	Indoor Air Temp. °F (°C) WB											
		60.8 (16)		63.5 (17.5)		64.4 (18)		66.2 (19)		71.6 (22)		75.2 (24)	
		Total Capacity (BTU/h)	Input Power (kW)	Total Capacity (BTU/h)	Input Power (kW)	Total Capacity (BTU/h)	Input Power (kW)	Total Capacity (BTU/h)	Input Power (kW)	Total Capacity (BTU/h)	Input Power (kW)	Total Capacity (BTU/h)	Input Power (kW)
1.6 + 1.6 + 2.0 + 2.5	71.6 (22)	30465.10	1.32	27689.20	1.37	26763.89	1.39	24913.29	1.43	31177.41	1.68	35353.48	1.84
	77.0 (25)	30726.98	1.83	29103.34	1.85	28562.12	1.86	27479.69	1.88	32078.27	2.04	35143.98	2.14
	84.2 (29)	31215.81	2.37	30552.39	2.37	30331.25	2.37	29888.97	2.37	32738.20	2.44	34637.68	2.48
	89.6 (32)	30692.06	2.68	30831.73	2.67	30878.28	2.66	30971.40	2.65	32877.87	2.67	34148.84	2.69
	95.0 (35)	30342.89	2.91	30866.64	2.89	31041.23	2.88	31390.40	2.87	32668.36	2.85	33520.34	2.84
	104.0 (40)	29365.21	3.09	30028.64	3.08	30249.78	3.08	30692.06	3.08	30566.36	3.04	30482.56	3.01
	109.4 (43)	28457.37	3.07	28946.21	3.09	29109.15	3.10	29435.05	3.11	30545.41	3.08	31285.65	3.06
	114.8 (46)	27374.94	2.98	27462.24	3.02	27491.33	3.04	27549.53	3.07	29162.69	3.06	30238.14	3.06
1.6 + 1.6 + 2.0 + 3.2	71.6 (22)	30465.10	1.32	27689.20	1.37	26763.89	1.39	24913.29	1.43	31177.41	1.68	35353.48	1.84
	77.0 (25)	30726.98	1.83	29103.34	1.85	28562.12	1.86	27479.69	1.88	32078.27	2.04	35143.98	2.14
	84.2 (29)	31215.81	2.37	30552.39	2.37	30331.25	2.37	29888.97	2.37	32738.20	2.44	34637.68	2.48
	89.6 (32)	30692.06	2.68	30831.73	2.67	30878.28	2.66	30971.40	2.65	32877.87	2.67	34148.84	2.69
	95.0 (35)	30342.89	2.91	30866.64	2.89	31041.23	2.88	31390.40	2.87	32668.36	2.85	33520.34	2.84
	104.0 (40)	29365.21	3.09	30028.64	3.08	30249.78	3.08	30692.06	3.08	30566.36	3.04	30482.56	3.01
	109.4 (43)	28457.37	3.07	28946.21	3.09	29109.15	3.10	29435.05	3.11	30545.41	3.08	31285.65	3.06
	114.8 (46)	27374.94	2.98	27462.24	3.02	27491.33	3.04	27549.53	3.07	29162.69	3.06	30238.14	3.06
1.6 + 1.6 + 2.0 + 5.0	71.6 (22)	30465.10	1.22	27689.20	1.27	26763.89	1.29	24913.29	1.33	31177.41	1.55	35353.48	1.70
	77.0 (25)	30726.98	1.69	29103.34	1.72	28562.12	1.73	27479.69	1.74	32078.27	1.89	35143.98	1.98
	84.2 (29)	31215.81	2.20	30552.39	2.20	30331.25	2.20	29888.97	2.20	32738.20	2.26	34637.68	2.30
	89.6 (32)	30692.06	2.49	30831.73	2.47	30878.28	2.47	30971.40	2.46	32877.87	2.48	34148.84	2.49
	95.0 (35)	30342.89	2.69	30866.64	2.68	31041.23	2.67	31390.40	2.66	32668.36	2.65	33520.34	2.64
	104.0 (40)	29365.21	2.86	30028.64	2.86	30249.78	2.85	30692.06	2.85	30566.36	2.82	30482.56	2.79
	109.4 (43)	28457.37	2.85	28946.21	2.86	29109.15	2.87	29435.05	2.88	30545.41	2.86	31285.65	2.84
	114.8 (46)	27374.94	2.76	27462.24	2.80	27491.33	2.82	27549.53	2.84	29162.69	2.84	30238.14	2.84
1.6 + 1.6 + 2.0 + 7.0	71.6 (22)	30465.10	1.22	27689.20	1.27	26763.89	1.29	24913.29	1.33	31177.41	1.55	35353.48	1.70
	77.0 (25)	30726.98	1.69	29103.34	1.72	28562.12	1.73	27479.69	1.74	32078.27	1.89	35143.98	1.98
	84.2 (29)	31215.81	2.20	30552.39	2.20	30331.25	2.20	29888.97	2.20	32738.20	2.26	34637.68	2.30
	89.6 (32)	30692.06	2.49	30831.73	2.47	30878.28	2.47	30971.40	2.46	32877.87	2.48	34148.84	2.49
	95.0 (35)	30342.89	2.69	30866.64	2.68	31041.23	2.67	31390.40	2.66	32668.36	2.65	33520.34	2.64
	104.0 (40)	29365.21	2.86	30028.64	2.86	30249.78	2.85	30692.06	2.85	30566.36	2.82	30482.56	2.79
	109.4 (43)	28457.37	2.85	28946.21	2.86	29109.15	2.87	29435.05	2.88	30545.41	2.86	31285.65	2.84
	114.8 (46)	27374.94	2.76	27462.24	2.80	27491.33	2.82	27549.53	2.84	29162.69	2.84	30238.14	2.84

Combination (Capacity)	Outdoor Air Temp. °F (°C) DB	Indoor Air Temp. °F (°C) WB											
		60.8 (16)		63.5 (17.5)		64.4 (18)		66.2 (19)		71.6 (22)		75.2 (24)	
		Total Capacity (BTU/h)	Input Power (kW)	Total Capacity (BTU/h)	Input Power (kW)	Total Capacity (BTU/h)	Input Power (kW)	Total Capacity (BTU/h)	Input Power (kW)	Total Capacity (BTU/h)	Input Power (kW)	Total Capacity (BTU/h)	Input Power (kW)
1.6 + 1.6 + 2.5 + 2.5	71.6 (22)	30465.10	1.32	27689.20	1.37	26763.89	1.39	24913.29	1.43	31177.41	1.68	35353.48	1.84
	77.0 (25)	30726.98	1.83	29103.34	1.85	28562.12	1.86	27479.69	1.88	32078.27	2.04	35143.98	2.14
	84.2 (29)	31215.81	2.37	30552.39	2.37	30331.25	2.37	29888.97	2.37	32738.20	2.44	34637.68	2.48
	89.6 (32)	30692.06	2.68	30831.73	2.67	30878.28	2.66	30971.40	2.65	32877.87	2.67	34148.84	2.69
	95.0 (35)	30342.89	2.91	30866.64	2.89	31041.23	2.88	31390.40	2.87	32668.36	2.85	33520.34	2.84
	104.0 (40)	29365.21	3.09	30028.64	3.08	30249.78	3.08	30692.06	3.08	30566.36	3.04	30482.56	3.01
	109.4 (43)	28457.37	3.07	28946.21	3.09	29109.15	3.10	29435.05	3.11	30545.41	3.08	31285.65	3.06
	114.8 (46)	27374.94	2.98	27462.24	3.02	27491.33	3.04	27549.53	3.07	29162.69	3.06	30238.14	3.06
1.6 + 1.6 + 2.5 + 3.2	71.6 (22)	30465.10	1.32	27689.20	1.37	26763.89	1.39	24913.29	1.43	31177.41	1.68	35353.48	1.84
	77.0 (25)	30726.98	1.83	29103.34	1.85	28562.12	1.86	27479.69	1.88	32078.27	2.04	35143.98	2.14
	84.2 (29)	31215.81	2.37	30552.39	2.37	30331.25	2.37	29888.97	2.37	32738.20	2.44	34637.68	2.48
	89.6 (32)	30692.06	2.68	30831.73	2.67	30878.28	2.66	30971.40	2.65	32877.87	2.67	34148.84	2.69
	95.0 (35)	30342.89	2.91	30866.64	2.89	31041.23	2.88	31390.40	2.87	32668.36	2.85	33520.34	2.84
	104.0 (40)	29365.21	3.09	30028.64	3.08	30249.78	3.08	30692.06	3.08	30566.36	3.04	30482.56	3.01
	109.4 (43)	28457.37	3.07	28946.21	3.09	29109.15	3.10	29435.05	3.11	30545.41	3.08	31285.65	3.06
	114.8 (46)	27374.94	2.98	27462.24	3.02	27491.33	3.04	27549.53	3.07	29162.69	3.06	30238.14	3.06
1.6 + 1.6 + 2.5 + 5.0	71.6 (22)	30465.10	1.22	27689.20	1.27	26763.89	1.29	24913.29	1.33	31177.41	1.55	35353.48	1.70
	77.0 (25)	30726.98	1.69	29103.34	1.72	28562.12	1.73	27479.69	1.74	32078.27	1.89	35143.98	1.98
	84.2 (29)	31215.81	2.20	30552.39	2.20	30331.25	2.20	29888.97	2.20	32738.20	2.26	34637.68	2.30
	89.6 (32)	30692.06	2.49	30831.73	2.47	30878.28	2.47	30971.40	2.46	32877.87	2.48	34148.84	2.49
	95.0 (35)	30342.89	2.69	30866.64	2.68	31041.23	2.67	31390.40	2.66	32668.36	2.65	33520.34	2.64
	104.0 (40)	29365.21	2.86	30028.64	2.86	30249.78	2.85	30692.06	2.85	30566.36	2.82	30482.56	2.79
	109.4 (43)	28457.37	2.85	28946.21	2.86	29109.15	2.87	29435.05	2.88	30545.41	2.86	31285.65	2.84
	114.8 (46)	27374.94	2.76	27462.24	2.80	27491.33	2.82	27549.53	2.84	29162.69	2.84	30238.14	2.84
1.6 + 1.6 + 2.5 + 7.0	71.6 (22)	30465.10	1.22	27689.20	1.27	26763.89	1.29	24913.29	1.33	31177.41	1.55	35353.48	1.70
	77.0 (25)	30726.98	1.69	29103.34	1.72	28562.12	1.73	27479.69	1.74	32078.27	1.89	35143.98	1.98
	84.2 (29)	31215.81	2.20	30552.39	2.20	30331.25	2.20	29888.97	2.20	32738.20	2.26	34637.68	2.30
	89.6 (32)	30692.06	2.49	30831.73	2.47	30878.28	2.47	30971.40	2.46	32877.87	2.48	34148.84	2.49
	95.0 (35)	30342.89	2.69	30866.64	2.68	31041.23	2.67	31390.40	2.66	32668.36	2.65	33520.34	2.64
	104.0 (40)	29365.21	2.86	30028.64	2.86	30249.78	2.85	30692.06	2.85	30566.36	2.82	30482.56	2.79
	109.4 (43)	28457.37	2.85	28946.21	2.86	29109.15	2.87	29435.05	2.88	30545.41	2.86	31285.65	2.84
	114.8 (46)	27374.94	2.76	27462.24	2.80	27491.33	2.82	27549.53	2.84	29162.69	2.84	30238.14	2.84

Combination (Capacity)	Outdoor Air Temp. °F (°C) DB	Indoor Air Temp. °F (°C) WB											
		60.8 (16)		63.5 (17.5)		64.4 (18)		66.2 (19)		71.6 (22)		75.2 (24)	
		Total Capacity (BTU/h)	Input Power (kW)	Total Capacity (BTU/h)	Input Power (kW)	Total Capacity (BTU/h)	Input Power (kW)	Total Capacity (BTU/h)	Input Power (kW)	Total Capacity (BTU/h)	Input Power (kW)	Total Capacity (BTU/h)	Input Power (kW)
1.6 + 1.6 + 3.2 + 3.2	71.6 (22)	30465.10	1.28	27689.20	1.34	26763.89	1.36	24913.29	1.40	31177.41	1.63	35353.48	1.79
	77.0 (25)	30726.98	1.78	29103.34	1.81	28562.12	1.82	27479.69	1.84	32078.27	1.99	35143.98	2.09
	84.2 (29)	31215.81	2.31	30552.39	2.31	30331.25	2.31	29888.97	2.31	32738.20	2.38	34637.68	2.42
	89.6 (32)	30692.06	2.62	30831.73	2.60	30878.28	2.60	30971.40	2.59	32877.87	2.61	34148.84	2.62
	95.0 (35)	30342.89	2.84	30866.64	2.82	31041.23	2.81	31390.40	2.80	32668.36	2.78	33520.34	2.77
	104.0 (40)	29365.21	3.01	30028.64	3.01	30249.78	3.00	30692.06	3.00	30566.36	2.96	30482.56	2.94
	109.4 (43)	28457.37	3.00	28946.21	3.01	29109.15	3.02	29435.05	3.03	30545.41	3.01	31285.65	2.99
	114.8 (46)	27374.94	2.91	27462.24	2.95	27491.33	2.96	27549.53	2.99	29162.69	2.99	30238.14	2.99
1.6 + 1.6 + 3.2 + 5.0	71.6 (22)	30465.10	1.22	27689.20	1.27	26763.89	1.29	24913.29	1.33	31177.41	1.55	35353.48	1.70
	77.0 (25)	30726.98	1.69	29103.34	1.72	28562.12	1.73	27479.69	1.74	32078.27	1.89	35143.98	1.98
	84.2 (29)	31215.81	2.20	30552.39	2.20	30331.25	2.20	29888.97	2.20	32738.20	2.26	34637.68	2.30
	89.6 (32)	30692.06	2.49	30831.73	2.47	30878.28	2.47	30971.40	2.46	32877.87	2.48	34148.84	2.49
	95.0 (35)	30342.89	2.69	30866.64	2.68	31041.23	2.67	31390.40	2.66	32668.36	2.65	33520.34	2.64
	104.0 (40)	29365.21	2.86	30028.64	2.86	30249.78	2.85	30692.06	2.85	30566.36	2.82	30482.56	2.79
	109.4 (43)	28457.37	2.85	28946.21	2.86	29109.15	2.87	29435.05	2.88	30545.41	2.86	31285.65	2.84
	114.8 (46)	27374.94	2.76	27462.24	2.80	27491.33	2.82	27549.53	2.84	29162.69	2.84	30238.14	2.84
1.6 + 1.6 + 3.2 + 7.0	71.6 (22)	30465.10	1.19	27689.20	1.24	26763.89	1.26	24913.29	1.29	31177.41	1.51	35353.48	1.66
	77.0 (25)	30726.98	1.65	29103.34	1.67	28562.12	1.68	27479.69	1.70	32078.27	1.84	35143.98	1.93
	84.2 (29)	31215.81	2.14	30552.39	2.14	30331.25	2.14	29888.97	2.14	32738.20	2.20	34637.68	2.24
	89.6 (32)	30692.06	2.42	30831.73	2.41	30878.28	2.40	30971.40	2.40	32877.87	2.41	34148.84	2.42
	95.0 (35)	30342.89	2.62	30866.64	2.61	31041.23	2.60	31390.40	2.59	32668.36	2.58	33520.34	2.57
	104.0 (40)	29365.21	2.78	30028.64	2.78	30249.78	2.78	30692.06	2.78	30566.36	2.74	30482.56	2.72
	109.4 (43)	28457.37	2.77	28946.21	2.79	29109.15	2.79	29435.05	2.80	30545.41	2.78	31285.65	2.76
	114.8 (46)	27374.94	2.69	27462.24	2.73	27491.33	2.74	27549.53	2.77	29162.69	2.77	30238.14	2.76
1.6 + 1.6 + 5.0 + 5.0	71.6 (22)	30465.10	1.19	27689.20	1.25	26763.89	1.26	24913.29	1.30	31177.41	1.52	35353.48	1.66
	77.0 (25)	30726.98	1.66	29103.34	1.68	28562.12	1.69	27479.69	1.70	32078.27	1.84	35143.98	1.94
	84.2 (29)	31215.81	2.15	30552.39	2.15	30331.25	2.15	29888.97	2.15	32738.20	2.21	34637.68	2.25
	89.6 (32)	30692.06	2.43	30831.73	2.42	30878.28	2.41	30971.40	2.40	32877.87	2.42	34148.84	2.43
	95.0 (35)	30342.89	2.63	30866.64	2.62	31041.23	2.61	31390.40	2.60	32668.36	2.59	33520.34	2.58
	104.0 (40)	29365.21	2.80	30028.64	2.79	30249.78	2.79	30692.06	2.79	30566.36	2.75	30482.56	2.73
	109.4 (43)	28457.37	2.78	28946.21	2.80	29109.15	2.80	29435.05	2.82	30545.41	2.79	31285.65	2.77
	114.8 (46)	27374.94	2.70	27462.24	2.74	27491.33	2.75	27549.53	2.78	29162.69	2.78	30238.14	2.77

Combination (Capacity)	Outdoor Air Temp. °F (°C) DB	Indoor Air Temp. °F (°C) WB											
		60.8 (16)		63.5 (17.5)		64.4 (18)		66.2 (19)		71.6 (22)		75.2 (24)	
		Total Capacity (BTU/h)	Input Power (kW)	Total Capacity (BTU/h)	Input Power (kW)	Total Capacity (BTU/h)	Input Power (kW)	Total Capacity (BTU/h)	Input Power (kW)	Total Capacity (BTU/h)	Input Power (kW)	Total Capacity (BTU/h)	Input Power (kW)
1.6 + 2.0 + 2.0 + 2.0	71.6 (22)	30465.10	1.32	27689.20	1.37	26763.89	1.39	24913.29	1.43	31177.41	1.68	35353.48	1.84
	77.0 (25)	30726.98	1.83	29103.34	1.85	28562.12	1.86	27479.69	1.88	32078.27	2.04	35143.98	2.14
	84.2 (29)	31215.81	2.37	30552.39	2.37	30331.25	2.37	29888.97	2.37	32738.20	2.44	34637.68	2.48
	89.6 (32)	30692.06	2.68	30831.73	2.67	30878.28	2.66	30971.40	2.65	32877.87	2.67	34148.84	2.69
	95.0 (35)	30342.89	2.91	30866.64	2.89	31041.23	2.88	31390.40	2.87	32668.36	2.85	33520.34	2.84
	104.0 (40)	29365.21	3.09	30028.64	3.08	30249.78	3.08	30692.06	3.08	30566.36	3.04	30482.56	3.01
	109.4 (43)	28457.37	3.07	28946.21	3.09	29109.15	3.10	29435.05	3.11	30545.41	3.08	31285.65	3.06
	114.8 (46)	27374.94	2.98	27462.24	3.02	27491.33	3.04	27549.53	3.07	29162.69	3.06	30238.14	3.06
1.6 + 2.0 + 2.0 + 2.5	71.6 (22)	30465.10	1.32	27689.20	1.37	26763.89	1.39	24913.29	1.43	31177.41	1.68	35353.48	1.84
	77.0 (25)	30726.98	1.83	29103.34	1.85	28562.12	1.86	27479.69	1.88	32078.27	2.04	35143.98	2.14
	84.2 (29)	31215.81	2.37	30552.39	2.37	30331.25	2.37	29888.97	2.37	32738.20	2.44	34637.68	2.48
	89.6 (32)	30692.06	2.68	30831.73	2.67	30878.28	2.66	30971.40	2.65	32877.87	2.67	34148.84	2.69
	95.0 (35)	30342.89	2.91	30866.64	2.89	31041.23	2.88	31390.40	2.87	32668.36	2.85	33520.34	2.84
	104.0 (40)	29365.21	3.09	30028.64	3.08	30249.78	3.08	30692.06	3.08	30566.36	3.04	30482.56	3.01
	109.4 (43)	28457.37	3.07	28946.21	3.09	29109.15	3.10	29435.05	3.11	30545.41	3.08	31285.65	3.06
	114.8 (46)	27374.94	2.98	27462.24	3.02	27491.33	3.04	27549.53	3.07	29162.69	3.06	30238.14	3.06
1.6 + 2.0 + 2.0 + 3.2	71.6 (22)	30465.10	1.28	27689.20	1.34	26763.89	1.36	24913.29	1.40	31177.41	1.63	35353.48	1.79
	77.0 (25)	30726.98	1.78	29103.34	1.81	28562.12	1.82	27479.69	1.84	32078.27	1.99	35143.98	2.09
	84.2 (29)	31215.81	2.31	30552.39	2.31	30331.25	2.31	29888.97	2.31	32738.20	2.38	34637.68	2.42
	89.6 (32)	30692.06	2.62	30831.73	2.60	30878.28	2.60	30971.40	2.59	32877.87	2.61	34148.84	2.62
	95.0 (35)	30342.89	2.84	30866.64	2.82	31041.23	2.81	31390.40	2.80	32668.36	2.78	33520.34	2.77
	104.0 (40)	29365.21	3.01	30028.64	3.01	30249.78	3.00	30692.06	3.00	30566.36	2.96	30482.56	2.94
	109.4 (43)	28457.37	3.00	28946.21	3.01	29109.15	3.02	29435.05	3.03	30545.41	3.01	31285.65	2.99
	114.8 (46)	27374.94	2.91	27462.24	2.95	27491.33	2.96	27549.53	2.99	29162.69	2.99	30238.14	2.99
1.6 + 2.0 + 2.0 + 5.0	71.6 (22)	30465.10	1.22	27689.20	1.27	26763.89	1.29	24913.29	1.33	31177.41	1.55	35353.48	1.70
	77.0 (25)	30726.98	1.69	29103.34	1.72	28562.12	1.73	27479.69	1.74	32078.27	1.89	35143.98	1.98
	84.2 (29)	31215.81	2.20	30552.39	2.20	30331.25	2.20	29888.97	2.20	32738.20	2.26	34637.68	2.30
	89.6 (32)	30692.06	2.49	30831.73	2.47	30878.28	2.47	30971.40	2.46	32877.87	2.48	34148.84	2.49
	95.0 (35)	30342.89	2.69	30866.64	2.68	31041.23	2.67	31390.40	2.66	32668.36	2.65	33520.34	2.64
	104.0 (40)	29365.21	2.86	30028.64	2.86	30249.78	2.85	30692.06	2.85	30566.36	2.82	30482.56	2.79
	109.4 (43)	28457.37	2.85	28946.21	2.86	29109.15	2.87	29435.05	2.88	30545.41	2.86	31285.65	2.84
	114.8 (46)	27374.94	2.76	27462.24	2.80	27491.33	2.82	27549.53	2.84	29162.69	2.84	30238.14	2.84

Combination (Capacity)	Outdoor Air Temp. °F (°C) DB	Indoor Air Temp. °F (°C) WB											
		60.8 (16)		63.5 (17.5)		64.4 (18)		66.2 (19)		71.6 (22)		75.2 (24)	
		Total Capacity (BTU/h)	Input Power (kW)	Total Capacity (BTU/h)	Input Power (kW)	Total Capacity (BTU/h)	Input Power (kW)	Total Capacity (BTU/h)	Input Power (kW)	Total Capacity (BTU/h)	Input Power (kW)	Total Capacity (BTU/h)	Input Power (kW)
1.6 + 2.0 + 2.0 + 7.0	71.6 (22)	30465.10	1.22	27689.20	1.27	26763.89	1.29	24913.29	1.33	31177.41	1.55	35353.48	1.70
	77.0 (25)	30726.98	1.69	29103.34	1.72	28562.12	1.73	27479.69	1.74	32078.27	1.89	35143.98	1.98
	84.2 (29)	31215.81	2.20	30552.39	2.20	30331.25	2.20	29888.97	2.20	32738.20	2.26	34637.68	2.30
	89.6 (32)	30692.06	2.49	30831.73	2.47	30878.28	2.47	30971.40	2.46	32877.87	2.48	34148.84	2.49
	95.0 (35)	30342.89	2.69	30866.64	2.68	31041.23	2.67	31390.40	2.66	32668.36	2.65	33520.34	2.64
	104.0 (40)	29365.21	2.86	30028.64	2.86	30249.78	2.85	30692.06	2.85	30566.36	2.82	30482.56	2.79
	109.4 (43)	28457.37	2.85	28946.21	2.86	29109.15	2.87	29435.05	2.88	30545.41	2.86	31285.65	2.84
	114.8 (46)	27374.94	2.76	27462.24	2.80	27491.33	2.82	27549.53	2.84	29162.69	2.84	30238.14	2.84
1.6 + 2.0 + 2.5 + 2.5	71.6 (22)	30465.10	1.32	27689.20	1.37	26763.89	1.39	24913.29	1.43	31177.41	1.68	35353.48	1.84
	77.0 (25)	30726.98	1.83	29103.34	1.85	28562.12	1.86	27479.69	1.88	32078.27	2.04	35143.98	2.14
	84.2 (29)	31215.81	2.37	30552.39	2.37	30331.25	2.37	29888.97	2.37	32738.20	2.44	34637.68	2.48
	89.6 (32)	30692.06	2.68	30831.73	2.67	30878.28	2.66	30971.40	2.65	32877.87	2.67	34148.84	2.69
	95.0 (35)	30342.89	2.91	30866.64	2.89	31041.23	2.88	31390.40	2.87	32668.36	2.85	33520.34	2.84
	104.0 (40)	29365.21	3.09	30028.64	3.08	30249.78	3.08	30692.06	3.08	30566.36	3.04	30482.56	3.01
	109.4 (43)	28457.37	3.07	28946.21	3.09	29109.15	3.10	29435.05	3.11	30545.41	3.08	31285.65	3.06
	114.8 (46)	27374.94	2.98	27462.24	3.02	27491.33	3.04	27549.53	3.07	29162.69	3.06	30238.14	3.06
1.6 + 2.0 + 2.5 + 3.2	71.6 (22)	30465.10	1.28	27689.20	1.34	26763.89	1.36	24913.29	1.40	31177.41	1.63	35353.48	1.79
	77.0 (25)	30726.98	1.78	29103.34	1.81	28562.12	1.82	27479.69	1.84	32078.27	1.99	35143.98	2.09
	84.2 (29)	31215.81	2.31	30552.39	2.31	30331.25	2.31	29888.97	2.31	32738.20	2.38	34637.68	2.42
	89.6 (32)	30692.06	2.62	30831.73	2.60	30878.28	2.60	30971.40	2.59	32877.87	2.61	34148.84	2.62
	95.0 (35)	30342.89	2.84	30866.64	2.82	31041.23	2.81	31390.40	2.80	32668.36	2.78	33520.34	2.77
	104.0 (40)	29365.21	3.01	30028.64	3.01	30249.78	3.00	30692.06	3.00	30566.36	2.96	30482.56	2.94
	109.4 (43)	28457.37	3.00	28946.21	3.01	29109.15	3.02	29435.05	3.03	30545.41	3.01	31285.65	2.99
	114.8 (46)	27374.94	2.91	27462.24	2.95	27491.33	2.96	27549.53	2.99	29162.69	2.99	30238.14	2.99
1.6 + 2.0 + 2.5 + 5.0	71.6 (22)	30465.10	1.22	27689.20	1.27	26763.89	1.29	24913.29	1.33	31177.41	1.55	35353.48	1.70
	77.0 (25)	30726.98	1.69	29103.34	1.72	28562.12	1.73	27479.69	1.74	32078.27	1.89	35143.98	1.98
	84.2 (29)	31215.81	2.20	30552.39	2.20	30331.25	2.20	29888.97	2.20	32738.20	2.26	34637.68	2.30
	89.6 (32)	30692.06	2.49	30831.73	2.47	30878.28	2.47	30971.40	2.46	32877.87	2.48	34148.84	2.49
	95.0 (35)	30342.89	2.69	30866.64	2.68	31041.23	2.67	31390.40	2.66	32668.36	2.65	33520.34	2.64
	104.0 (40)	29365.21	2.86	30028.64	2.86	30249.78	2.85	30692.06	2.85	30566.36	2.82	30482.56	2.79
	109.4 (43)	28457.37	2.85	28946.21	2.86	29109.15	2.87	29435.05	2.88	30545.41	2.86	31285.65	2.84
	114.8 (46)	27374.94	2.76	27462.24	2.80	27491.33	2.82	27549.53	2.84	29162.69	2.84	30238.14	2.84

Combination (Capacity)	Outdoor Air Temp. °F (°C) DB	Indoor Air Temp. °F (°C) WB											
		60.8 (16)		63.5 (17.5)		64.4 (18)		66.2 (19)		71.6 (22)		75.2 (24)	
		Total Capacity (BTU/h)	Input Power (kW)	Total Capacity (BTU/h)	Input Power (kW)	Total Capacity (BTU/h)	Input Power (kW)	Total Capacity (BTU/h)	Input Power (kW)	Total Capacity (BTU/h)	Input Power (kW)	Total Capacity (BTU/h)	Input Power (kW)
1.6 + 2.0 + 2.5 + 7.0	71.6 (22)	30465.10	1.22	27689.20	1.27	26763.89	1.29	24913.29	1.33	31177.41	1.55	35353.48	1.70
	77.0 (25)	30726.98	1.69	29103.34	1.72	28562.12	1.73	27479.69	1.74	32078.27	1.89	35143.98	1.98
	84.2 (29)	31215.81	2.20	30552.39	2.20	30331.25	2.20	29888.97	2.20	32738.20	2.26	34637.68	2.30
	89.6 (32)	30692.06	2.49	30831.73	2.47	30878.28	2.47	30971.40	2.46	32877.87	2.48	34148.84	2.49
	95.0 (35)	30342.89	2.69	30866.64	2.68	31041.23	2.67	31390.40	2.66	32668.36	2.65	33520.34	2.64
	104.0 (40)	29365.21	2.86	30028.64	2.86	30249.78	2.85	30692.06	2.85	30566.36	2.82	30482.56	2.79
	109.4 (43)	28457.37	2.85	28946.21	2.86	29109.15	2.87	29435.05	2.88	30545.41	2.86	31285.65	2.84
	114.8 (46)	27374.94	2.76	27462.24	2.80	27491.33	2.82	27549.53	2.84	29162.69	2.84	30238.14	2.84
1.6 + 2.0 + 3.2 + 3.2	71.6 (22)	30465.10	1.28	27689.20	1.34	26763.89	1.36	24913.29	1.40	31177.41	1.63	35353.48	1.79
	77.0 (25)	30726.98	1.78	29103.34	1.81	28562.12	1.82	27479.69	1.84	32078.27	1.99	35143.98	2.09
	84.2 (29)	31215.81	2.31	30552.39	2.31	30331.25	2.31	29888.97	2.31	32738.20	2.38	34637.68	2.42
	89.6 (32)	30692.06	2.62	30831.73	2.60	30878.28	2.60	30971.40	2.59	32877.87	2.61	34148.84	2.62
	95.0 (35)	30342.89	2.84	30866.64	2.82	31041.23	2.81	31390.40	2.80	32668.36	2.78	33520.34	2.77
	104.0 (40)	29365.21	3.01	30028.64	3.01	30249.78	3.00	30692.06	3.00	30566.36	2.96	30482.56	2.94
	109.4 (43)	28457.37	3.00	28946.21	3.01	29109.15	3.02	29435.05	3.03	30545.41	3.01	31285.65	2.99
	114.8 (46)	27374.94	2.91	27462.24	2.95	27491.33	2.96	27549.53	2.99	29162.69	2.99	30238.14	2.99
1.6 + 2.0 + 3.2 + 5.0	71.6 (22)	30465.10	1.22	27689.20	1.27	26763.89	1.29	24913.29	1.33	31177.41	1.55	35353.48	1.70
	77.0 (25)	30726.98	1.69	29103.34	1.72	28562.12	1.73	27479.69	1.74	32078.27	1.89	35143.98	1.98
	84.2 (29)	31215.81	2.20	30552.39	2.20	30331.25	2.20	29888.97	2.20	32738.20	2.26	34637.68	2.30
	89.6 (32)	30692.06	2.49	30831.73	2.47	30878.28	2.47	30971.40	2.46	32877.87	2.48	34148.84	2.49
	95.0 (35)	30342.89	2.69	30866.64	2.68	31041.23	2.67	31390.40	2.66	32668.36	2.65	33520.34	2.64
	104.0 (40)	29365.21	2.86	30028.64	2.86	30249.78	2.85	30692.06	2.85	30566.36	2.82	30482.56	2.79
	109.4 (43)	28457.37	2.85	28946.21	2.86	29109.15	2.87	29435.05	2.88	30545.41	2.86	31285.65	2.84
	114.8 (46)	27374.94	2.76	27462.24	2.80	27491.33	2.82	27549.53	2.84	29162.69	2.84	30238.14	2.84
1.6 + 2.0 + 5.0 + 5.0	71.6 (22)	30465.10	1.19	27689.20	1.25	26763.89	1.26	24913.29	1.30	31177.41	1.52	35353.48	1.66
	77.0 (25)	30726.98	1.66	29103.34	1.68	28562.12	1.69	27479.69	1.70	32078.27	1.84	35143.98	1.94
	84.2 (29)	31215.81	2.15	30552.39	2.15	30331.25	2.15	29888.97	2.15	32738.20	2.21	34637.68	2.25
	89.6 (32)	30692.06	2.43	30831.73	2.42	30878.28	2.41	30971.40	2.40	32877.87	2.42	34148.84	2.43
	95.0 (35)	30342.89	2.63	30866.64	2.62	31041.23	2.61	31390.40	2.60	32668.36	2.59	33520.34	2.58
	104.0 (40)	29365.21	2.80	30028.64	2.79	30249.78	2.79	30692.06	2.79	30566.36	2.75	30482.56	2.73
	109.4 (43)	28457.37	2.78	28946.21	2.80	29109.15	2.80	29435.05	2.82	30545.41	2.79	31285.65	2.77
	114.8 (46)	27374.94	2.70	27462.24	2.74	27491.33	2.75	27549.53	2.78	29162.69	2.78	30238.14	2.77

Combination (Capacity)	Outdoor Air Temp. °F (°C) DB	Indoor Air Temp. °F (°C) WB											
		60.8 (16)		63.5 (17.5)		64.4 (18)		66.2 (19)		71.6 (22)		75.2 (24)	
		Total Capacity (BTU/h)	Input Power (kW)	Total Capacity (BTU/h)	Input Power (kW)	Total Capacity (BTU/h)	Input Power (kW)	Total Capacity (BTU/h)	Input Power (kW)	Total Capacity (BTU/h)	Input Power (kW)	Total Capacity (BTU/h)	Input Power (kW)
1.6 + 2.5 + 2.5 + 2.5	71.6 (22)	30465.10	1.32	27689.20	1.37	26763.89	1.39	24913.29	1.43	31177.41	1.68	35353.48	1.84
	77.0 (25)	30726.98	1.83	29103.34	1.85	28562.12	1.86	27479.69	1.88	32078.27	2.04	35143.98	2.14
	84.2 (29)	31215.81	2.37	30552.39	2.37	30331.25	2.37	29888.97	2.37	32738.20	2.44	34637.68	2.48
	89.6 (32)	30692.06	2.68	30831.73	2.67	30878.28	2.66	30971.40	2.65	32877.87	2.67	34148.84	2.69
	95.0 (35)	30342.89	2.91	30866.64	2.89	31041.23	2.88	31390.40	2.87	32668.36	2.85	33520.34	2.84
	104.0 (40)	29365.21	3.09	30028.64	3.08	30249.78	3.08	30692.06	3.08	30566.36	3.04	30482.56	3.01
	109.4 (43)	28457.37	3.07	28946.21	3.09	29109.15	3.10	29435.05	3.11	30545.41	3.08	31285.65	3.06
	114.8 (46)	27374.94	2.98	27462.24	3.02	27491.33	3.04	27549.53	3.07	29162.69	3.06	30238.14	3.06
1.6 + 2.5 + 2.5 + 3.2	71.6 (22)	30465.10	1.28	27689.20	1.34	26763.89	1.36	24913.29	1.40	31177.41	1.63	35353.48	1.79
	77.0 (25)	30726.98	1.78	29103.34	1.81	28562.12	1.82	27479.69	1.84	32078.27	1.99	35143.98	2.09
	84.2 (29)	31215.81	2.31	30552.39	2.31	30331.25	2.31	29888.97	2.31	32738.20	2.38	34637.68	2.42
	89.6 (32)	30692.06	2.62	30831.73	2.60	30878.28	2.60	30971.40	2.59	32877.87	2.61	34148.84	2.62
	95.0 (35)	30342.89	2.84	30866.64	2.82	31041.23	2.81	31390.40	2.80	32668.36	2.78	33520.34	2.77
	104.0 (40)	29365.21	3.01	30028.64	3.01	30249.78	3.00	30692.06	3.00	30566.36	2.96	30482.56	2.94
	109.4 (43)	28457.37	3.00	28946.21	3.01	29109.15	3.02	29435.05	3.03	30545.41	3.01	31285.65	2.99
	114.8 (46)	27374.94	2.91	27462.24	2.95	27491.33	2.96	27549.53	2.99	29162.69	2.99	30238.14	2.99
1.6 + 2.5 + 2.5 + 5.0	71.6 (22)	30465.10	1.22	27689.20	1.27	26763.89	1.29	24913.29	1.33	31177.41	1.55	35353.48	1.70
	77.0 (25)	30726.98	1.69	29103.34	1.72	28562.12	1.73	27479.69	1.74	32078.27	1.89	35143.98	1.98
	84.2 (29)	31215.81	2.20	30552.39	2.20	30331.25	2.20	29888.97	2.20	32738.20	2.26	34637.68	2.30
	89.6 (32)	30692.06	2.49	30831.73	2.47	30878.28	2.47	30971.40	2.46	32877.87	2.48	34148.84	2.49
	95.0 (35)	30342.89	2.69	30866.64	2.68	31041.23	2.67	31390.40	2.66	32668.36	2.65	33520.34	2.64
	104.0 (40)	29365.21	2.86	30028.64	2.86	30249.78	2.85	30692.06	2.85	30566.36	2.82	30482.56	2.79
	109.4 (43)	28457.37	2.85	28946.21	2.86	29109.15	2.87	29435.05	2.88	30545.41	2.86	31285.65	2.84
	114.8 (46)	27374.94	2.76	27462.24	2.80	27491.33	2.82	27549.53	2.84	29162.69	2.84	30238.14	2.84
1.6 + 2.5 + 2.5 + 7.0	71.6 (22)	30465.10	1.22	27689.20	1.27	26763.89	1.29	24913.29	1.33	31177.41	1.55	35353.48	1.70
	77.0 (25)	30726.98	1.69	29103.34	1.72	28562.12	1.73	27479.69	1.74	32078.27	1.89	35143.98	1.98
	84.2 (29)	31215.81	2.20	30552.39	2.20	30331.25	2.20	29888.97	2.20	32738.20	2.26	34637.68	2.30
	89.6 (32)	30692.06	2.49	30831.73	2.47	30878.28	2.47	30971.40	2.46	32877.87	2.48	34148.84	2.49
	95.0 (35)	30342.89	2.69	30866.64	2.68	31041.23	2.67	31390.40	2.66	32668.36	2.65	33520.34	2.64
	104.0 (40)	29365.21	2.86	30028.64	2.86	30249.78	2.85	30692.06	2.85	30566.36	2.82	30482.56	2.79
	109.4 (43)	28457.37	2.85	28946.21	2.86	29109.15	2.87	29435.05	2.88	30545.41	2.86	31285.65	2.84
	114.8 (46)	27374.94	2.76	27462.24	2.80	27491.33	2.82	27549.53	2.84	29162.69	2.84	30238.14	2.84

Combination (Capacity)	Outdoor Air Temp. °F (°C) DB	Indoor Air Temp. °F (°C) WB											
		60.8 (16)		63.5 (17.5)		64.4 (18)		66.2 (19)		71.6 (22)		75.2 (24)	
		Total Capacity (BTU/h)	Input Power (kW)	Total Capacity (BTU/h)	Input Power (kW)	Total Capacity (BTU/h)	Input Power (kW)	Total Capacity (BTU/h)	Input Power (kW)	Total Capacity (BTU/h)	Input Power (kW)	Total Capacity (BTU/h)	Input Power (kW)
1.6 + 2.5+ 3.2 + 3.2	71.6 (22)	30465.10	1.28	27689.20	1.34	26763.89	1.36	24913.29	1.40	31177.41	1.63	35353.48	1.79
	77.0 (25)	30726.98	1.78	29103.34	1.81	28562.12	1.82	27479.69	1.84	32078.27	1.99	35143.98	2.09
	84.2 (29)	31215.81	2.31	30552.39	2.31	30331.25	2.31	29888.97	2.31	32738.20	2.38	34637.68	2.42
	89.6 (32)	30692.06	2.62	30831.73	2.60	30878.28	2.60	30971.40	2.59	32877.87	2.61	34148.84	2.62
	95.0 (35)	30342.89	2.84	30866.64	2.82	31041.23	2.81	31390.40	2.80	32668.36	2.78	33520.34	2.77
	104.0 (40)	29365.21	3.01	30028.64	3.01	30249.78	3.00	30692.06	3.00	30566.36	2.96	30482.56	2.94
	109.4 (43)	28457.37	3.00	28946.21	3.01	29109.15	3.02	29435.05	3.03	30545.41	3.01	31285.65	2.99
	114.8 (46)	27374.94	2.91	27462.24	2.95	27491.33	2.96	27549.53	2.99	29162.69	2.99	30238.14	2.99
1.6 + 2.5 + 3.2 + 5.0	71.6 (22)	30465.10	1.22	27689.20	1.27	26763.89	1.29	24913.29	1.33	31177.41	1.55	35353.48	1.70
	77.0 (25)	30726.98	1.69	29103.34	1.72	28562.12	1.73	27479.69	1.74	32078.27	1.89	35143.98	1.98
	84.2 (29)	31215.81	2.20	30552.39	2.20	30331.25	2.20	29888.97	2.20	32738.20	2.26	34637.68	2.30
	89.6 (32)	30692.06	2.49	30831.73	2.47	30878.28	2.47	30971.40	2.46	32877.87	2.48	34148.84	2.49
	95.0 (35)	30342.89	2.69	30866.64	2.68	31041.23	2.67	31390.40	2.66	32668.36	2.65	33520.34	2.64
	104.0 (40)	29365.21	2.86	30028.64	2.86	30249.78	2.85	30692.06	2.85	30566.36	2.82	30482.56	2.79
	109.4 (43)	28457.37	2.85	28946.21	2.86	29109.15	2.87	29435.05	2.88	30545.41	2.86	31285.65	2.84
	114.8 (46)	27374.94	2.76	27462.24	2.80	27491.33	2.82	27549.53	2.84	29162.69	2.84	30238.14	2.84
1.6 + 3.2+ 3.2 + 3.2	71.6 (22)	30465.10	1.25	27689.20	1.31	26763.89	1.33	24913.29	1.36	31177.41	1.59	35353.48	1.75
	77.0 (25)	30726.98	1.74	29103.34	1.76	28562.12	1.77	27479.69	1.79	32078.27	1.94	35143.98	2.03
	84.2 (29)	31215.81	2.26	30552.39	2.26	30331.25	2.26	29888.97	2.26	32738.20	2.32	34637.68	2.36
	89.6 (32)	30692.06	2.55	30831.73	2.54	30878.28	2.53	30971.40	2.52	32877.87	2.54	34148.84	2.55
	95.0 (35)	30342.89	2.76	30866.64	2.75	31041.23	2.74	31390.40	2.73	32668.36	2.71	33520.34	2.70
	104.0 (40)	29365.21	2.94	30028.64	2.93	30249.78	2.93	30692.06	2.93	30566.36	2.89	30482.56	2.87
	109.4 (43)	28457.37	2.92	28946.21	2.94	29109.15	2.95	29435.05	2.96	30545.41	2.93	31285.65	2.91
	114.8 (46)	27374.94	2.83	27462.24	2.88	27491.33	2.89	27549.53	2.92	29162.69	2.92	30238.14	2.91
1.6 + 3.2+ 3.2 + 5.0	71.6 (22)	30465.10	1.19	27689.20	1.24	26763.89	1.26	24913.29	1.29	31177.41	1.51	35353.48	1.66
	77.0 (25)	30726.98	1.65	29103.34	1.67	28562.12	1.68	27479.69	1.70	32078.27	1.84	35143.98	1.93
	84.2 (29)	31215.81	2.14	30552.39	2.14	30331.25	2.14	29888.97	2.14	32738.20	2.20	34637.68	2.24
	89.6 (32)	30692.06	2.42	30831.73	2.41	30878.28	2.40	30971.40	2.40	32877.87	2.41	34148.84	2.42
	95.0 (35)	30342.89	2.62	30866.64	2.61	31041.23	2.60	31390.40	2.59	32668.36	2.58	33520.34	2.57
	104.0 (40)	29365.21	2.78	30028.64	2.78	30249.78	2.78	30692.06	2.78	30566.36	2.74	30482.56	2.72
	109.4 (43)	28457.37	2.77	28946.21	2.79	29109.15	2.79	29435.05	2.80	30545.41	2.78	31285.65	2.76
	114.8 (46)	27374.94	2.69	27462.24	2.73	27491.33	2.74	27549.53	2.77	29162.69	2.77	30238.14	2.76

Combination (Capacity)	Outdoor Air Temp. °F (°C) DB	Indoor Air Temp. °F (°C) WB											
		60.8 (16)		63.5 (17.5)		64.4 (18)		66.2 (19)		71.6 (22)		75.2 (24)	
		Total Capacity (BTU/h)	Input Power (kW)	Total Capacity (BTU/h)	Input Power (kW)	Total Capacity (BTU/h)	Input Power (kW)	Total Capacity (BTU/h)	Input Power (kW)	Total Capacity (BTU/h)	Input Power (kW)	Total Capacity (BTU/h)	Input Power (kW)
2.0 + 2.0 + 2.0 + 2.0	71.6 (22)	30465.10	1.32	27689.20	1.37	26763.89	1.39	24913.29	1.43	31177.41	1.68	35353.48	1.84
	77.0 (25)	30726.98	1.83	29103.34	1.85	28562.12	1.86	27479.69	1.88	32078.27	2.04	35143.98	2.14
	84.2 (29)	31215.81	2.37	30552.39	2.37	30331.25	2.37	29888.97	2.37	32738.20	2.44	34637.68	2.48
	89.6 (32)	30692.06	2.68	30831.73	2.67	30878.28	2.66	30971.40	2.65	32877.87	2.67	34148.84	2.69
	95.0 (35)	30342.89	2.91	30866.64	2.89	31041.23	2.88	31390.40	2.87	32668.36	2.85	33520.34	2.84
	104.0 (40)	29365.21	3.09	30028.64	3.08	30249.78	3.08	30692.06	3.08	30566.36	3.04	30482.56	3.01
	109.4 (43)	28457.37	3.07	28946.21	3.09	29109.15	3.10	29435.05	3.11	30545.41	3.08	31285.65	3.06
	114.8 (46)	27374.94	2.98	27462.24	3.02	27491.33	3.04	27549.53	3.07	29162.69	3.06	30238.14	3.06
2.0 + 2.0 + 2.0 + 2.5	71.6 (22)	30465.10	1.32	27689.20	1.37	26763.89	1.39	24913.29	1.43	31177.41	1.68	35353.48	1.84
	77.0 (25)	30726.98	1.83	29103.34	1.85	28562.12	1.86	27479.69	1.88	32078.27	2.04	35143.98	2.14
	84.2 (29)	31215.81	2.37	30552.39	2.37	30331.25	2.37	29888.97	2.37	32738.20	2.44	34637.68	2.48
	89.6 (32)	30692.06	2.68	30831.73	2.67	30878.28	2.66	30971.40	2.65	32877.87	2.67	34148.84	2.69
	95.0 (35)	30342.89	2.91	30866.64	2.89	31041.23	2.88	31390.40	2.87	32668.36	2.85	33520.34	2.84
	104.0 (40)	29365.21	3.09	30028.64	3.08	30249.78	3.08	30692.06	3.08	30566.36	3.04	30482.56	3.01
	109.4 (43)	28457.37	3.07	28946.21	3.09	29109.15	3.10	29435.05	3.11	30545.41	3.08	31285.65	3.06
	114.8 (46)	27374.94	2.98	27462.24	3.02	27491.33	3.04	27549.53	3.07	29162.69	3.06	30238.14	3.06
2.0 + 2.0 + 2.0 + 3.2	71.6 (22)	30465.10	1.28	27689.20	1.34	26763.89	1.36	24913.29	1.40	31177.41	1.63	35353.48	1.79
	77.0 (25)	30726.98	1.78	29103.34	1.81	28562.12	1.82	27479.69	1.84	32078.27	1.99	35143.98	2.09
	84.2 (29)	31215.81	2.31	30552.39	2.31	30331.25	2.31	29888.97	2.31	32738.20	2.38	34637.68	2.42
	89.6 (32)	30692.06	2.62	30831.73	2.60	30878.28	2.60	30971.40	2.59	32877.87	2.61	34148.84	2.62
	95.0 (35)	30342.89	2.84	30866.64	2.82	31041.23	2.81	31390.40	2.80	32668.36	2.78	33520.34	2.77
	104.0 (40)	29365.21	3.01	30028.64	3.01	30249.78	3.00	30692.06	3.00	30566.36	2.96	30482.56	2.94
	109.4 (43)	28457.37	3.00	28946.21	3.01	29109.15	3.02	29435.05	3.03	30545.41	3.01	31285.65	2.99
	114.8 (46)	27374.94	2.91	27462.24	2.95	27491.33	2.96	27549.53	2.99	29162.69	2.99	30238.14	2.99
2.0 + 2.0 + 2.0 + 5.0	71.6 (22)	30465.10	1.22	27689.20	1.27	26763.89	1.29	24913.29	1.33	31177.41	1.55	35353.48	1.70
	77.0 (25)	30726.98	1.69	29103.34	1.72	28562.12	1.73	27479.69	1.74	32078.27	1.89	35143.98	1.98
	84.2 (29)	31215.81	2.20	30552.39	2.20	30331.25	2.20	29888.97	2.20	32738.20	2.26	34637.68	2.30
	89.6 (32)	30692.06	2.49	30831.73	2.47	30878.28	2.47	30971.40	2.46	32877.87	2.48	34148.84	2.49
	95.0 (35)	30342.89	2.69	30866.64	2.68	31041.23	2.67	31390.40	2.66	32668.36	2.65	33520.34	2.64
	104.0 (40)	29365.21	2.86	30028.64	2.86	30249.78	2.85	30692.06	2.85	30566.36	2.82	30482.56	2.79
	109.4 (43)	28457.37	2.85	28946.21	2.86	29109.15	2.87	29435.05	2.88	30545.41	2.86	31285.65	2.84
	114.8 (46)	27374.94	2.76	27462.24	2.80	27491.33	2.82	27549.53	2.84	29162.69	2.84	30238.14	2.84

Combination (Capacity)	Outdoor Air Temp. °F (°C) DB	Indoor Air Temp. °F (°C) WB											
		60.8 (16)		63.5 (17.5)		64.4 (18)		66.2 (19)		71.6 (22)		75.2 (24)	
		Total Capacity (BTU/h)	Input Power (kW)	Total Capacity (BTU/h)	Input Power (kW)	Total Capacity (BTU/h)	Input Power (kW)	Total Capacity (BTU/h)	Input Power (kW)	Total Capacity (BTU/h)	Input Power (kW)	Total Capacity (BTU/h)	Input Power (kW)
2.0+ 2.0 + 2.0 + 7.0	71.6 (22)	30465.10	1.22	27689.20	1.27	26763.89	1.29	24913.29	1.33	31177.41	1.55	35353.48	1.70
	77.0 (25)	30726.98	1.69	29103.34	1.72	28562.12	1.73	27479.69	1.74	32078.27	1.89	35143.98	1.98
	84.2 (29)	31215.81	2.20	30552.39	2.20	30331.25	2.20	29888.97	2.20	32738.20	2.26	34637.68	2.30
	89.6 (32)	30692.06	2.49	30831.73	2.47	30878.28	2.47	30971.40	2.46	32877.87	2.48	34148.84	2.49
	95.0 (35)	30342.89	2.69	30866.64	2.68	31041.23	2.67	31390.40	2.66	32668.36	2.65	33520.34	2.64
	104.0 (40)	29365.21	2.86	30028.64	2.86	30249.78	2.85	30692.06	2.85	30566.36	2.82	30482.56	2.79
	109.4 (43)	28457.37	2.85	28946.21	2.86	29109.15	2.87	29435.05	2.88	30545.41	2.86	31285.65	2.84
	114.8 (46)	27374.94	2.76	27462.24	2.80	27491.33	2.82	27549.53	2.84	29162.69	2.84	30238.14	2.84
2.0 + 2.0+ 2.5 + 2.5	71.6 (22)	30465.10	1.32	27689.20	1.37	26763.89	1.39	24913.29	1.43	31177.41	1.68	35353.48	1.84
	77.0 (25)	30726.98	1.83	29103.34	1.85	28562.12	1.86	27479.69	1.88	32078.27	2.04	35143.98	2.14
	84.2 (29)	31215.81	2.37	30552.39	2.37	30331.25	2.37	29888.97	2.37	32738.20	2.44	34637.68	2.48
	89.6 (32)	30692.06	2.68	30831.73	2.67	30878.28	2.66	30971.40	2.65	32877.87	2.67	34148.84	2.69
	95.0 (35)	30342.89	2.91	30866.64	2.89	31041.23	2.88	31390.40	2.87	32668.36	2.85	33520.34	2.84
	104.0 (40)	29365.21	3.09	30028.64	3.08	30249.78	3.08	30692.06	3.08	30566.36	3.04	30482.56	3.01
	109.4 (43)	28457.37	3.07	28946.21	3.09	29109.15	3.10	29435.05	3.11	30545.41	3.08	31285.65	3.06
	114.8 (46)	27374.94	2.98	27462.24	3.02	27491.33	3.04	27549.53	3.07	29162.69	3.06	30238.14	3.06
2.0 + 2.0 + 2.5 + 3.2	71.6 (22)	30465.10	1.28	27689.20	1.34	26763.89	1.36	24913.29	1.40	31177.41	1.63	35353.48	1.79
	77.0 (25)	30726.98	1.78	29103.34	1.81	28562.12	1.82	27479.69	1.84	32078.27	1.99	35143.98	2.09
	84.2 (29)	31215.81	2.31	30552.39	2.31	30331.25	2.31	29888.97	2.31	32738.20	2.38	34637.68	2.42
	89.6 (32)	30692.06	2.62	30831.73	2.60	30878.28	2.60	30971.40	2.59	32877.87	2.61	34148.84	2.62
	95.0 (35)	30342.89	2.84	30866.64	2.82	31041.23	2.81	31390.40	2.80	32668.36	2.78	33520.34	2.77
	104.0 (40)	29365.21	3.01	30028.64	3.01	30249.78	3.00	30692.06	3.00	30566.36	2.96	30482.56	2.94
	109.4 (43)	28457.37	3.00	28946.21	3.01	29109.15	3.02	29435.05	3.03	30545.41	3.01	31285.65	2.99
	114.8 (46)	27374.94	2.91	27462.24	2.95	27491.33	2.96	27549.53	2.99	29162.69	2.99	30238.14	2.99
2.0 + 2.0 + 2.5 + 5.0	71.6 (22)	30465.10	1.22	27689.20	1.27	26763.89	1.29	24913.29	1.33	31177.41	1.55	35353.48	1.70
	77.0 (25)	30726.98	1.69	29103.34	1.72	28562.12	1.73	27479.69	1.74	32078.27	1.89	35143.98	1.98
	84.2 (29)	31215.81	2.20	30552.39	2.20	30331.25	2.20	29888.97	2.20	32738.20	2.26	34637.68	2.30
	89.6 (32)	30692.06	2.49	30831.73	2.47	30878.28	2.47	30971.40	2.46	32877.87	2.48	34148.84	2.49
	95.0 (35)	30342.89	2.69	30866.64	2.68	31041.23	2.67	31390.40	2.66	32668.36	2.65	33520.34	2.64
	104.0 (40)	29365.21	2.86	30028.64	2.86	30249.78	2.85	30692.06	2.85	30566.36	2.82	30482.56	2.79
	109.4 (43)	28457.37	2.85	28946.21	2.86	29109.15	2.87	29435.05	2.88	30545.41	2.86	31285.65	2.84
	114.8 (46)	27374.94	2.76	27462.24	2.80	27491.33	2.82	27549.53	2.84	29162.69	2.84	30238.14	2.84

Combination (Capacity)	Outdoor Air Temp. °F (°C) DB	Indoor Air Temp. °F (°C) WB											
		60.8 (16)		63.5 (17.5)		64.4 (18)		66.2 (19)		71.6 (22)		75.2 (24)	
		Total Capacity (BTU/h)	Input Power (kW)	Total Capacity (BTU/h)	Input Power (kW)	Total Capacity (BTU/h)	Input Power (kW)	Total Capacity (BTU/h)	Input Power (kW)	Total Capacity (BTU/h)	Input Power (kW)	Total Capacity (BTU/h)	Input Power (kW)
2.0 + 2.0 + 2.5 + 7.0	71.6 (22)	30465.10	1.22	27689.20	1.27	26763.89	1.29	24913.29	1.33	31177.41	1.55	35353.48	1.70
	77.0 (25)	30726.98	1.69	29103.34	1.72	28562.12	1.73	27479.69	1.74	32078.27	1.89	35143.98	1.98
	84.2 (29)	31215.81	2.20	30552.39	2.20	30331.25	2.20	29888.97	2.20	32738.20	2.26	34637.68	2.30
	89.6 (32)	30692.06	2.49	30831.73	2.47	30878.28	2.47	30971.40	2.46	32877.87	2.48	34148.84	2.49
	95.0 (35)	30342.89	2.69	30866.64	2.68	31041.23	2.67	31390.40	2.66	32668.36	2.65	33520.34	2.64
	104.0 (40)	29365.21	2.86	30028.64	2.86	30249.78	2.85	30692.06	2.85	30566.36	2.82	30482.56	2.79
	109.4 (43)	28457.37	2.85	28946.21	2.86	29109.15	2.87	29435.05	2.88	30545.41	2.86	31285.65	2.84
	114.8 (46)	27374.94	2.76	27462.24	2.80	27491.33	2.82	27549.53	2.84	29162.69	2.84	30238.14	2.84
2.0 + 2.0 + 3.2 + 3.2	71.6 (22)	30465.10	1.28	27689.20	1.34	26763.89	1.36	24913.29	1.40	31177.41	1.63	35353.48	1.79
	77.0 (25)	30726.98	1.78	29103.34	1.81	28562.12	1.82	27479.69	1.84	32078.27	1.99	35143.98	2.09
	84.2 (29)	31215.81	2.31	30552.39	2.31	30331.25	2.31	29888.97	2.31	32738.20	2.38	34637.68	2.42
	89.6 (32)	30692.06	2.62	30831.73	2.60	30878.28	2.60	30971.40	2.59	32877.87	2.61	34148.84	2.62
	95.0 (35)	30342.89	2.84	30866.64	2.82	31041.23	2.81	31390.40	2.80	32668.36	2.78	33520.34	2.77
	104.0 (40)	29365.21	3.01	30028.64	3.01	30249.78	3.00	30692.06	3.00	30566.36	2.96	30482.56	2.94
	109.4 (43)	28457.37	3.00	28946.21	3.01	29109.15	3.02	29435.05	3.03	30545.41	3.01	31285.65	2.99
	114.8 (46)	27374.94	2.91	27462.24	2.95	27491.33	2.96	27549.53	2.99	29162.69	2.99	30238.14	2.99
2.0 + 2.0 + 3.2 + 5.0	71.6 (22)	30465.10	1.22	27689.20	1.27	26763.89	1.29	24913.29	1.33	31177.41	1.55	35353.48	1.70
	77.0 (25)	30726.98	1.69	29103.34	1.72	28562.12	1.73	27479.69	1.74	32078.27	1.89	35143.98	1.98
	84.2 (29)	31215.81	2.20	30552.39	2.20	30331.25	2.20	29888.97	2.20	32738.20	2.26	34637.68	2.30
	89.6 (32)	30692.06	2.49	30831.73	2.47	30878.28	2.47	30971.40	2.46	32877.87	2.48	34148.84	2.49
	95.0 (35)	30342.89	2.69	30866.64	2.68	31041.23	2.67	31390.40	2.66	32668.36	2.65	33520.34	2.64
	104.0 (40)	29365.21	2.86	30028.64	2.86	30249.78	2.85	30692.06	2.85	30566.36	2.82	30482.56	2.79
	109.4 (43)	28457.37	2.85	28946.21	2.86	29109.15	2.87	29435.05	2.88	30545.41	2.86	31285.65	2.84
	114.8 (46)	27374.94	2.76	27462.24	2.80	27491.33	2.82	27549.53	2.84	29162.69	2.84	30238.14	2.84
2.0 + 2.5+ 2.5 + 2.5	71.6 (22)	30465.10	1.32	27689.20	1.37	26763.89	1.39	24913.29	1.43	31177.41	1.68	35353.48	1.84
	77.0 (25)	30726.98	1.83	29103.34	1.85	28562.12	1.86	27479.69	1.88	32078.27	2.04	35143.98	2.14
	84.2 (29)	31215.81	2.37	30552.39	2.37	30331.25	2.37	29888.97	2.37	32738.20	2.44	34637.68	2.48
	89.6 (32)	30692.06	2.68	30831.73	2.67	30878.28	2.66	30971.40	2.65	32877.87	2.67	34148.84	2.69
	95.0 (35)	30342.89	2.91	30866.64	2.89	31041.23	2.88	31390.40	2.87	32668.36	2.85	33520.34	2.84
	104.0 (40)	29365.21	3.09	30028.64	3.08	30249.78	3.08	30692.06	3.08	30566.36	3.04	30482.56	3.01
	109.4 (43)	28457.37	3.07	28946.21	3.09	29109.15	3.10	29435.05	3.11	30545.41	3.08	31285.65	3.06
	114.8 (46)	27374.94	2.98	27462.24	3.02	27491.33	3.04	27549.53	3.07	29162.69	3.06	30238.14	3.06

Combination (Capacity)	Outdoor Air Temp. °F (°C) DB	Indoor Air Temp. °F (°C) WB											
		60.8 (16)		63.5 (17.5)		64.4 (18)		66.2 (19)		71.6 (22)		75.2 (24)	
		Total Capacity (BTU/h)	Input Power (kW)	Total Capacity (BTU/h)	Input Power (kW)	Total Capacity (BTU/h)	Input Power (kW)	Total Capacity (BTU/h)	Input Power (kW)	Total Capacity (BTU/h)	Input Power (kW)	Total Capacity (BTU/h)	Input Power (kW)
2.0 + 2.5 + 2.5 + 3.2	71.6 (22)	30465.10	1.28	27689.20	1.34	26763.89	1.36	24913.29	1.40	31177.41	1.63	35353.48	1.79
	77.0 (25)	30726.98	1.78	29103.34	1.81	28562.12	1.82	27479.69	1.84	32078.27	1.99	35143.98	2.09
	84.2 (29)	31215.81	2.31	30552.39	2.31	30331.25	2.31	29888.97	2.31	32738.20	2.38	34637.68	2.42
	89.6 (32)	30692.06	2.62	30831.73	2.60	30878.28	2.60	30971.40	2.59	32877.87	2.61	34148.84	2.62
	95.0 (35)	30342.89	2.84	30866.64	2.82	31041.23	2.81	31390.40	2.80	32668.36	2.78	33520.34	2.77
	104.0 (40)	29365.21	3.01	30028.64	3.01	30249.78	3.00	30692.06	3.00	30566.36	2.96	30482.56	2.94
	109.4 (43)	28457.37	3.00	28946.21	3.01	29109.15	3.02	29435.05	3.03	30545.41	3.01	31285.65	2.99
	114.8 (46)	27374.94	2.91	27462.24	2.95	27491.33	2.96	27549.53	2.99	29162.69	2.99	30238.14	2.99
2.0 + 2.5 + 2.5 + 5.0	71.6 (22)	30465.10	1.22	27689.20	1.27	26763.89	1.29	24913.29	1.33	31177.41	1.55	35353.48	1.70
	77.0 (25)	30726.98	1.69	29103.34	1.72	28562.12	1.73	27479.69	1.74	32078.27	1.89	35143.98	1.98
	84.2 (29)	31215.81	2.20	30552.39	2.20	30331.25	2.20	29888.97	2.20	32738.20	2.26	34637.68	2.30
	89.6 (32)	30692.06	2.49	30831.73	2.47	30878.28	2.47	30971.40	2.46	32877.87	2.48	34148.84	2.49
	95.0 (35)	30342.89	2.69	30866.64	2.68	31041.23	2.67	31390.40	2.66	32668.36	2.65	33520.34	2.64
	104.0 (40)	29365.21	2.86	30028.64	2.86	30249.78	2.85	30692.06	2.85	30566.36	2.82	30482.56	2.79
	109.4 (43)	28457.37	2.85	28946.21	2.86	29109.15	2.87	29435.05	2.88	30545.41	2.86	31285.65	2.84
	114.8 (46)	27374.94	2.76	27462.24	2.80	27491.33	2.82	27549.53	2.84	29162.69	2.84	30238.14	2.84
2.0 + 2.5 + 3.2 + 3.2	71.6 (22)	30465.10	1.28	27689.20	1.34	26763.89	1.36	24913.29	1.40	31177.41	1.63	35353.48	1.79
	77.0 (25)	30726.98	1.78	29103.34	1.81	28562.12	1.82	27479.69	1.84	32078.27	1.99	35143.98	2.09
	84.2 (29)	31215.81	2.31	30552.39	2.31	30331.25	2.31	29888.97	2.31	32738.20	2.38	34637.68	2.42
	89.6 (32)	30692.06	2.62	30831.73	2.60	30878.28	2.60	30971.40	2.59	32877.87	2.61	34148.84	2.62
	95.0 (35)	30342.89	2.84	30866.64	2.82	31041.23	2.81	31390.40	2.80	32668.36	2.78	33520.34	2.77
	104.0 (40)	29365.21	3.01	30028.64	3.01	30249.78	3.00	30692.06	3.00	30566.36	2.96	30482.56	2.94
	109.4 (43)	28457.37	3.00	28946.21	3.01	29109.15	3.02	29435.05	3.03	30545.41	3.01	31285.65	2.99
	114.8 (46)	27374.94	2.91	27462.24	2.95	27491.33	2.96	27549.53	2.99	29162.69	2.99	30238.14	2.99
2.0 + 2.5 + 3.2 + 5.0	71.6 (22)	30465.10	1.22	27689.20	1.27	26763.89	1.29	24913.29	1.33	31177.41	1.55	35353.48	1.70
	77.0 (25)	30726.98	1.69	29103.34	1.72	28562.12	1.73	27479.69	1.74	32078.27	1.89	35143.98	1.98
	84.2 (29)	31215.81	2.20	30552.39	2.20	30331.25	2.20	29888.97	2.20	32738.20	2.26	34637.68	2.30
	89.6 (32)	30692.06	2.49	30831.73	2.47	30878.28	2.47	30971.40	2.46	32877.87	2.48	34148.84	2.49
	95.0 (35)	30342.89	2.69	30866.64	2.68	31041.23	2.67	31390.40	2.66	32668.36	2.65	33520.34	2.64
	104.0 (40)	29365.21	2.86	30028.64	2.86	30249.78	2.85	30692.06	2.85	30566.36	2.82	30482.56	2.79
	109.4 (43)	28457.37	2.85	28946.21	2.86	29109.15	2.87	29435.05	2.88	30545.41	2.86	31285.65	2.84
	114.8 (46)	27374.94	2.76	27462.24	2.80	27491.33	2.82	27549.53	2.84	29162.69	2.84	30238.14	2.84

Combination (Capacity)	Outdoor Air Temp. °F (°C) DB	Indoor Air Temp. °F (°C) WB											
		60.8 (16)		63.5 (17.5)		64.4 (18)		66.2 (19)		71.6 (22)		75.2 (24)	
		Total Capacity (BTU/h)	Input Power (kW)	Total Capacity (BTU/h)	Input Power (kW)	Total Capacity (BTU/h)	Input Power (kW)	Total Capacity (BTU/h)	Input Power (kW)	Total Capacity (BTU/h)	Input Power (kW)	Total Capacity (BTU/h)	Input Power (kW)
2.0 + 3.2+ 3.2 + 3.2	71.6 (22)	30465.10	1.25	27689.20	1.31	26763.89	1.33	24913.29	1.36	31177.41	1.59	35353.48	1.75
	77.0 (25)	30726.98	1.74	29103.34	1.76	28562.12	1.77	27479.69	1.79	32078.27	1.94	35143.98	2.03
	84.2 (29)	31215.81	2.26	30552.39	2.26	30331.25	2.26	29888.97	2.26	32738.20	2.32	34637.68	2.36
	89.6 (32)	30692.06	2.55	30831.73	2.54	30878.28	2.53	30971.40	2.52	32877.87	2.54	34148.84	2.55
	95.0 (35)	30342.89	2.76	30866.64	2.75	31041.23	2.74	31390.40	2.73	32668.36	2.71	33520.34	2.70
	104.0 (40)	29365.21	2.94	30028.64	2.93	30249.78	2.93	30692.06	2.93	30566.36	2.89	30482.56	2.87
	109.4 (43)	28457.37	2.92	28946.21	2.94	29109.15	2.95	29435.05	2.96	30545.41	2.93	31285.65	2.91
	114.8 (46)	27374.94	2.83	27462.24	2.88	27491.33	2.89	27549.53	2.92	29162.69	2.92	30238.14	2.91
2.0+ 3.2+ 3.2 + 5.0	71.6 (22)	30465.10	1.19	27689.20	1.24	26763.89	1.26	24913.29	1.29	31177.41	1.51	35353.48	1.66
	77.0 (25)	30726.98	1.65	29103.34	1.67	28562.12	1.68	27479.69	1.70	32078.27	1.84	35143.98	1.93
	84.2 (29)	31215.81	2.14	30552.39	2.14	30331.25	2.14	29888.97	2.14	32738.20	2.20	34637.68	2.24
	89.6 (32)	30692.06	2.42	30831.73	2.41	30878.28	2.40	30971.40	2.40	32877.87	2.41	34148.84	2.42
	95.0 (35)	30342.89	2.62	30866.64	2.61	31041.23	2.60	31390.40	2.59	32668.36	2.58	33520.34	2.57
	104.0 (40)	29365.21	2.78	30028.64	2.78	30249.78	2.78	30692.06	2.78	30566.36	2.74	30482.56	2.72
	109.4 (43)	28457.37	2.77	28946.21	2.79	29109.15	2.79	29435.05	2.80	30545.41	2.78	31285.65	2.76
	114.8 (46)	27374.94	2.69	27462.24	2.73	27491.33	2.74	27549.53	2.77	29162.69	2.77	30238.14	2.76
2.5 + 2.5+ 2.5 + 2.5	71.6 (22)	30465.10	1.32	27689.20	1.37	26763.89	1.39	24913.29	1.43	31177.41	1.68	35353.48	1.84
	77.0 (25)	30726.98	1.83	29103.34	1.85	28562.12	1.86	27479.69	1.88	32078.27	2.04	35143.98	2.14
	84.2 (29)	31215.81	2.37	30552.39	2.37	30331.25	2.37	29888.97	2.37	32738.20	2.44	34637.68	2.48
	89.6 (32)	30692.06	2.68	30831.73	2.67	30878.28	2.66	30971.40	2.65	32877.87	2.67	34148.84	2.69
	95.0 (35)	30342.89	2.91	30866.64	2.89	31041.23	2.88	31390.40	2.87	32668.36	2.85	33520.34	2.84
	104.0 (40)	29365.21	3.09	30028.64	3.08	30249.78	3.08	30692.06	3.08	30566.36	3.04	30482.56	3.01
	109.4 (43)	28457.37	3.07	28946.21	3.09	29109.15	3.10	29435.05	3.11	30545.41	3.08	31285.65	3.06
	114.8 (46)	27374.94	2.98	27462.24	3.02	27491.33	3.04	27549.53	3.07	29162.69	3.06	30238.14	3.06
2.5 + 2.5 + 2.5 + 3.2	71.6 (22)	30465.10	1.28	27689.20	1.34	26763.89	1.36	24913.29	1.40	31177.41	1.63	35353.48	1.79
	77.0 (25)	30726.98	1.78	29103.34	1.81	28562.12	1.82	27479.69	1.84	32078.27	1.99	35143.98	2.09
	84.2 (29)	31215.81	2.31	30552.39	2.31	30331.25	2.31	29888.97	2.31	32738.20	2.38	34637.68	2.42
	89.6 (32)	30692.06	2.62	30831.73	2.60	30878.28	2.60	30971.40	2.59	32877.87	2.61	34148.84	2.62
	95.0 (35)	30342.89	2.84	30866.64	2.82	31041.23	2.81	31390.40	2.80	32668.36	2.78	33520.34	2.77
	104.0 (40)	29365.21	3.01	30028.64	3.01	30249.78	3.00	30692.06	3.00	30566.36	2.96	30482.56	2.94
	109.4 (43)	28457.37	3.00	28946.21	3.01	29109.15	3.02	29435.05	3.03	30545.41	3.01	31285.65	2.99
	114.8 (46)	27374.94	2.91	27462.24	2.95	27491.33	2.96	27549.53	2.99	29162.69	2.99	30238.14	2.99

Combination (Capacity)	Outdoor Air Temp. °F (°C) DB	Indoor Air Temp. °F (°C) WB											
		60.8 (16)		63.5 (17.5)		64.4 (18)		66.2 (19)		71.6 (22)		75.2 (24)	
		Total Capacity (BTU/h)	Input Power (kW)	Total Capacity (BTU/h)	Input Power (kW)	Total Capacity (BTU/h)	Input Power (kW)	Total Capacity (BTU/h)	Input Power (kW)	Total Capacity (BTU/h)	Input Power (kW)	Total Capacity (BTU/h)	Input Power (kW)
2.5 + 2.5 + 2.5 + 5.0	71.6 (22)	30465.10	1.22	27689.20	1.27	26763.89	1.29	24913.29	1.33	31177.41	1.55	35353.48	1.70
	77.0 (25)	30726.98	1.69	29103.34	1.72	28562.12	1.73	27479.69	1.74	32078.27	1.89	35143.98	1.98
	84.2 (29)	31215.81	2.20	30552.39	2.20	30331.25	2.20	29888.97	2.20	32738.20	2.26	34637.68	2.30
	89.6 (32)	30692.06	2.49	30831.73	2.47	30878.28	2.47	30971.40	2.46	32877.87	2.48	34148.84	2.49
	95.0 (35)	30342.89	2.69	30866.64	2.68	31041.23	2.67	31390.40	2.66	32668.36	2.65	33520.34	2.64
	104.0 (40)	29365.21	2.86	30028.64	2.86	30249.78	2.85	30692.06	2.85	30566.36	2.82	30482.56	2.79
	109.4 (43)	28457.37	2.85	28946.21	2.86	29109.15	2.87	29435.05	2.88	30545.41	2.86	31285.65	2.84
	114.8 (46)	27374.94	2.76	27462.24	2.80	27491.33	2.82	27549.53	2.84	29162.69	2.84	30238.14	2.84
2.5 + 2.5+ 3.2 + 3.2	71.6 (22)	30465.10	1.28	27689.20	1.34	26763.89	1.36	24913.29	1.40	31177.41	1.63	35353.48	1.79
	77.0 (25)	30726.98	1.78	29103.34	1.81	28562.12	1.82	27479.69	1.84	32078.27	1.99	35143.98	2.09
	84.2 (29)	31215.81	2.31	30552.39	2.31	30331.25	2.31	29888.97	2.31	32738.20	2.38	34637.68	2.42
	89.6 (32)	30692.06	2.62	30831.73	2.60	30878.28	2.60	30971.40	2.59	32877.87	2.61	34148.84	2.62
	95.0 (35)	30342.89	2.84	30866.64	2.82	31041.23	2.81	31390.40	2.80	32668.36	2.78	33520.34	2.77
	104.0 (40)	29365.21	3.01	30028.64	3.01	30249.78	3.00	30692.06	3.00	30566.36	2.96	30482.56	2.94
	109.4 (43)	28457.37	3.00	28946.21	3.01	29109.15	3.02	29435.05	3.03	30545.41	3.01	31285.65	2.99
	114.8 (46)	27374.94	2.91	27462.24	2.95	27491.33	2.96	27549.53	2.99	29162.69	2.99	30238.14	2.99
2.5 + 2.5 + 3.2 + 5.0	71.6 (22)	30465.10	1.22	27689.20	1.27	26763.89	1.29	24913.29	1.33	31177.41	1.55	35353.48	1.70
	77.0 (25)	30726.98	1.69	29103.34	1.72	28562.12	1.73	27479.69	1.74	32078.27	1.89	35143.98	1.98
	84.2 (29)	31215.81	2.20	30552.39	2.20	30331.25	2.20	29888.97	2.20	32738.20	2.26	34637.68	2.30
	89.6 (32)	30692.06	2.49	30831.73	2.47	30878.28	2.47	30971.40	2.46	32877.87	2.48	34148.84	2.49
	95.0 (35)	30342.89	2.69	30866.64	2.68	31041.23	2.67	31390.40	2.66	32668.36	2.65	33520.34	2.64
	104.0 (40)	29365.21	2.86	30028.64	2.86	30249.78	2.85	30692.06	2.85	30566.36	2.82	30482.56	2.79
	109.4 (43)	28457.37	2.85	28946.21	2.86	29109.15	2.87	29435.05	2.88	30545.41	2.86	31285.65	2.84
	114.8 (46)	27374.94	2.76	27462.24	2.80	27491.33	2.82	27549.53	2.84	29162.69	2.84	30238.14	2.84
2.5 + 3.2+ 3.2 + 3.2	71.6 (22)	30465.10	1.25	27689.20	1.31	26763.89	1.33	24913.29	1.36	31177.41	1.59	35353.48	1.75
	77.0 (25)	30726.98	1.74	29103.34	1.76	28562.12	1.77	27479.69	1.79	32078.27	1.94	35143.98	2.03
	84.2 (29)	31215.81	2.26	30552.39	2.26	30331.25	2.26	29888.97	2.26	32738.20	2.32	34637.68	2.36
	89.6 (32)	30692.06	2.55	30831.73	2.54	30878.28	2.53	30971.40	2.52	32877.87	2.54	34148.84	2.55
	95.0 (35)	30342.89	2.76	30866.64	2.75	31041.23	2.74	31390.40	2.73	32668.36	2.71	33520.34	2.70
	104.0 (40)	29365.21	2.94	30028.64	2.93	30249.78	2.93	30692.06	2.93	30566.36	2.89	30482.56	2.87
	109.4 (43)	28457.37	2.92	28946.21	2.94	29109.15	2.95	29435.05	2.96	30545.41	2.93	31285.65	2.91
	114.8 (46)	27374.94	2.83	27462.24	2.88	27491.33	2.89	27549.53	2.92	29162.69	2.92	30238.14	2.91

Combination (Capacity)	Outdoor Air Temp. °F (°C) DB	Indoor Air Temp. °F (°C) WB											
		60.8 (16)		63.5 (17.5)		64.4 (18)		66.2 (19)		71.6 (22)		75.2 (24)	
		Total Capacity (BTU/h)	Input Power (kW)	Total Capacity (BTU/h)	Input Power (kW)	Total Capacity (BTU/h)	Input Power (kW)	Total Capacity (BTU/h)	Input Power (kW)	Total Capacity (BTU/h)	Input Power (kW)	Total Capacity (BTU/h)	Input Power (kW)
3.2 + 3.2+ 3.2 + 3.2	71.6 (22)	30465.10	1.25	27689.20	1.31	26763.89	1.33	24913.29	1.36	31177.41	1.59	35353.48	1.75
	77.0 (25)	30726.98	1.74	29103.34	1.76	28562.12	1.77	27479.69	1.79	32078.27	1.94	35143.98	2.03
	84.2 (29)	31215.81	2.26	30552.39	2.26	30331.25	2.26	29888.97	2.26	32738.20	2.32	34637.68	2.36
	89.6 (32)	30692.06	2.55	30831.73	2.54	30878.28	2.53	30971.40	2.52	32877.87	2.54	34148.84	2.55
	95.0 (35)	30342.89	2.76	30866.64	2.75	31041.23	2.74	31390.40	2.73	32668.36	2.71	33520.34	2.70
	104.0 (40)	29365.21	2.94	30028.64	2.93	30249.78	2.93	30692.06	2.93	30566.36	2.89	30482.56	2.87
	109.4 (43)	28457.37	2.92	28946.21	2.94	29109.15	2.95	29435.05	2.96	30545.41	2.93	31285.65	2.91
	114.8 (46)	27374.94	2.83	27462.24	2.88	27491.33	2.89	27549.53	2.92	29162.69	2.92	30238.14	2.91

17.2.2.2 Heating

Heating: 60Hz, 230V

Maximum capacity and Input power

Combination (Capacity)	Indoor Air Temp. °F (°C) DB	Outdoor Air Temp. °F (°C) WB																					
		60.8 (16)		59.0 (15)		50.0 (10)		44.6 (7)		42.8 (6)		35.6 (2)		32.0 (0)		23.0 (-5)		19.4 (-7)		14.0 (-10)		5.0 (-15)	
		Total Capacity (BTU/h)	Input Power (kW)	Total Capacity (BTU/h)	Input Power (kW)	Total Capacity (BTU/h)	Input Power (kW)	Total Capacity (BTU/h)	Input Power (kW)	Total Capacity (BTU/h)	Input Power (kW)	Total Capacity (BTU/h)	Input Power (kW)	Total Capacity (BTU/h)	Input Power (kW)	Total Capacity (BTU/h)	Input Power (kW)	Total Capacity (BTU/h)	Input Power (kW)	Total Capacity (BTU/h)	Input Power (kW)	Total Capacity (BTU/h)	Input Power (kW)
1.6 + 3.2	60.8 (16)	40298.11	2.05	39534.79	2.09	35718.20	2.32	33428.24	2.46	31286.68	2.56	22720.46	2.99	23360.11	3.01	24959.24	3.04	25598.89	3.05	23152.22	2.92	19074.44	2.69
	64.4 (18)	38379.15	2.12	37504.96	2.16	33134.00	2.37	30511.42	2.50	28577.11	2.61	20839.88	3.08	21923.02	3.06	24630.89	3.04	25714.03	3.02	23281.75	2.90	19227.95	2.70
	68.0 (20)	37151.02	2.19	36131.84	2.23	31035.94	2.42	27978.40	2.53	26205.28	2.64	19112.82	3.08	20588.28	3.06	24276.94	3.02	25752.41	3.00	23204.99	2.92	18959.30	2.77
	69.8 (21)	36690.47	2.24	35594.53	2.26	30114.84	2.40	26827.03	2.49	25115.32	2.61	18268.48	3.09	19471.02	3.07	22477.39	3.02	23679.94	3.00	21794.56	2.92	18652.27	2.79
	71.6 (22)	36383.43	2.28	35632.91	2.31	31880.28	2.46	29628.70	2.55	27195.47	2.66	17462.51	3.10	19304.71	3.08	23910.21	3.02	25752.41	3.00	22917.15	2.94	18191.72	2.83
	75.2 (24)	36153.16	2.36	34805.62	2.39	28067.95	2.50	24025.35	2.57	22398.07	2.69	15888.97	3.14	18055.26	3.11	23470.98	3.05	25637.27	3.02	22399.03	2.98	17001.96	2.92
1.6 + 5.0	60.8 (16)	54058.44	2.90	53034.47	2.96	47914.65	3.28	44842.76	3.48	41969.94	3.63	30478.66	4.23	31336.73	4.25	33481.91	4.30	34339.98	4.32	31057.86	4.13	25587.66	3.80
	64.4 (18)	51484.22	3.00	50311.53	3.06	44448.05	3.36	40929.96	3.54	38335.15	3.70	27955.93	4.35	29408.93	4.34	33041.43	4.29	34494.43	4.28	31231.62	4.11	25793.60	3.82
	68.0 (20)	49836.73	3.10	48469.54	3.16	41633.58	3.42	37532.00	3.58	35153.43	3.73	25639.14	4.35	27618.43	4.33	32566.63	4.27	34545.91	4.25	31128.65	4.13	25433.21	3.92
	69.8 (21)	49218.92	3.16	47748.76	3.20	40397.96	3.40	35987.47	3.52	33691.28	3.69	24506.49	4.37	26119.66	4.34	30152.59	4.27	31765.77	4.25	29236.60	4.14	25021.33	3.95
	71.6 (22)	48807.05	3.22	47800.24	3.27	42766.23	3.48	39745.82	3.61	36481.72	3.76	23425.32	4.38	25896.57	4.35	32074.67	4.28	34545.91	4.25	30742.52	4.16	24403.52	4.01
	75.2 (24)	48498.14	3.34	46690.47	3.38	37652.13	3.54	32229.12	3.64	30046.19	3.80	21314.47	4.44	24220.47	4.41	31485.46	4.31	34391.46	4.28	30047.48	4.22	22807.51	4.13
1.6 + 7.0	60.8 (16)	63887.24	3.67	62677.10	3.75	56626.41	4.15	52995.99	4.40	49600.84	4.59	36020.24	5.36	37034.32	5.38	39569.53	5.44	40583.61	5.47	36704.74	5.22	30239.96	4.81
	64.4 (18)	60844.99	3.80	59459.08	3.87	52529.51	4.25	48371.77	4.47	45305.18	4.68	33038.83	5.51	34756.01	5.49	39048.96	5.43	40766.15	5.41	36910.09	5.19	30483.34	4.83
	68.0 (20)	58897.95	3.93	57282.18	4.00	49203.32	4.33	44356.00	4.53	41544.96	4.73	30300.81	5.51	32639.96	5.48	38487.84	5.41	40826.99	5.38	36788.40	5.22	30057.43	4.96
	69.8 (21)	58167.81	4.00	56430.35	4.05	47743.04	4.31	42530.65	4.46	39816.96	4.67	28962.22	5.53	30868.69	5.49	35634.88	5.41	37541.36	5.38	34552.35	5.23	29570.67	5.00
	71.6 (22)	57681.05	4.08	56491.20	4.13	50541.91	4.40	46972.33	4.57	43114.76	4.76	27684.47	5.55	30605.03	5.51	37906.43	5.41	40826.99	5.38	36332.07	5.26	28840.53	5.08
	75.2 (24)	57315.98	4.23	55179.65	4.27	44497.97	4.48	38088.97	4.61	35509.14	4.81	25189.83	5.62	28624.19	5.57	37210.09	5.46	40644.46	5.41	35510.66	5.34	26954.33	5.23
2.0 + 2.5	60.8 (16)	40298.11	2.06	39534.79	2.10	35718.20	2.33	33428.24	2.47	31286.68	2.57	22720.46	3.00	23360.11	3.02	24959.24	3.05	25598.89	3.07	23152.22	2.93	19074.44	2.70
	64.4 (18)	38379.15	2.13	37504.96	2.17	33134.00	2.38	30511.42	2.51	28577.11	2.62	20839.88	3.09	21923.02	3.08	24630.89	3.05	25714.03	3.04	23281.75	2.91	19227.95	2.71
	68.0 (20)	37151.02	2.20	36131.84	2.24	31035.94	2.43	27978.40	2.54	26205.28	2.65	19112.82	3.09	20588.28	3.07	24276.94	3.03	25752.41	3.01	23204.99	2.93	18959.30	2.78
	69.8 (21)	36690.47	2.24	35594.53	2.27	30114.84	2.41	26827.03	2.50	25115.32	2.62	18268.48	3.10	19471.02	3.08	22477.39	3.03	23679.94	3.01	21794.56	2.94	18652.27	2.80
	71.6 (22)	36383.43	2.29	35632.91	2.32	31880.28	2.47	29628.70	2.56	27195.47	2.67	17462.51	3.11	19304.71	3.09	23910.21	3.04	25752.41	3.01	22917.15	2.95	18191.72	2.85
	75.2 (24)	36153.16	2.37	34805.62	2.39	28067.95	2.51	24025.35	2.58	22398.07	2.70	15888.97	3.15	18055.26	3.13	23470.98	3.06	25637.27	3.04	22399.03	3.00	17001.96	2.93
2.0 + 3.2	60.8 (16)	42263.87	2.15	41463.31	2.20	37460.55	2.44	35058.89	2.58	32812.86	2.70	23828.77	3.15	24499.63	3.16	26176.76	3.20	26847.62	3.21	24281.60	3.07	20004.90	2.83
	64.4 (18)	40251.30	2.23	39334.47	2.27	34750.29	2.49	31999.79	2.63	29971.12	2.75	21856.46	3.23	22992.44	3.22	25832.39	3.19	26968.37	3.18	24417.45	3.05	20165.90	2.84
	68.0 (20)	38963.26	2.31	37894.37	2.35	32549.89	2.54	29343.20	2.66	27483.59	2.77	20045.15	3.23	21592.59	3.22	25461.19	3.17	27008.62	3.16	24336.94	3.07	19884.14	2.91
	69.8 (21)	38480.25	2.35	37330.85	2.38	31583.86	2.53	28135.66	2.62	26340.45	2.74	19159.62	3.24	20420.83	3.23	23573.85	3.18	24835.05	3.16	22857.71	3.07	19562.13	2.94
	71.6 (22)	38158.24	2.40	37371.10	2.43	33435.42	2.59	31074.01	2.68	28522.07	2.80	18314.34	3.26	20246.41	3.23	25076.56	3.18	27008.62	3.16	24035.06	3.09	19079.12	2.98
	75.2 (24)	37916.73	2.48	36503.46	2.51	29437.12	2.63	25197.32	2.70	23490.66	2.82	16664.04	3.30	18936.00	3.27	24615.91	3.21	26887.87	3.18	23491.67	3.14	17831.33	3.07

Combination (Capacity)	Indoor Air Temp. °F (°C) DB	Outdoor Air Temp. °F (°C) WB																					
		60.8 (16)		59.0 (15)		50.0 (10)		44.6 (7)		42.8 (6)		35.6 (2)		32.0 (0)		23.0 (-5)		19.4 (-7)		14.0 (-10)		5.0 (-15)	
		Total Capacity (BTU/h)	Input Power (kW)	Total Capacity (BTU/h)	Input Power (kW)	Total Capacity (BTU/h)	Input Power (kW)	Total Capacity (BTU/h)	Input Power (kW)	Total Capacity (BTU/h)	Input Power (kW)	Total Capacity (BTU/h)	Input Power (kW)	Total Capacity (BTU/h)	Input Power (kW)	Total Capacity (BTU/h)	Input Power (kW)	Total Capacity (BTU/h)	Input Power (kW)	Total Capacity (BTU/h)	Input Power (kW)	Total Capacity (BTU/h)	Input Power (kW)
2.0 + 5.0	60.8 (16)	54058.44	2.89	53034.47	2.95	47914.65	3.27	44842.76	3.47	41969.94	3.62	30478.66	4.22	31336.73	4.24	33481.91	4.29	34339.98	4.31	31057.86	4.12	25587.66	3.79
	64.4 (18)	51484.22	2.99	50311.53	3.05	44448.05	3.35	40929.96	3.53	38335.15	3.69	27955.93	4.34	29408.93	4.32	33041.43	4.28	34494.43	4.27	31231.62	4.09	25793.60	3.81
	68.0 (20)	49836.73	3.10	48469.54	3.15	41633.58	3.41	37532.00	3.57	35153.43	3.72	25639.14	4.34	27618.43	4.32	32566.63	4.26	34545.91	4.24	31128.65	4.11	25433.21	3.91
	69.8 (21)	49218.92	3.16	47748.76	3.19	40397.96	3.39	35987.47	3.51	33691.28	3.68	24506.49	4.36	26119.66	4.33	30152.59	4.26	31765.77	4.24	29236.60	4.13	25021.33	3.94
	71.6 (22)	48807.05	3.21	47800.24	3.26	42766.23	3.47	39745.82	3.60	36481.72	3.75	23425.32	4.37	25896.57	4.34	32074.67	4.27	34545.91	4.24	30742.52	4.15	24403.52	4.00
	75.2 (24)	48498.14	3.33	46690.47	3.37	37652.13	3.53	32229.12	3.63	30046.19	3.79	21314.47	4.43	24220.47	4.39	31485.46	4.30	34391.46	4.27	30047.48	4.21	22807.51	4.12
2.0 + 7.0	60.8 (16)	63887.24	3.61	62677.10	3.69	56626.41	4.09	52995.99	4.33	49600.84	4.52	36020.24	5.27	37034.32	5.30	39569.53	5.36	40583.61	5.39	36704.74	5.14	30239.96	4.74
	64.4 (18)	60844.99	3.74	59459.08	3.81	52529.51	4.18	48371.77	4.40	45305.18	4.61	33038.83	5.42	34756.01	5.40	39048.96	5.35	40766.15	5.33	36910.09	5.11	30483.34	4.76
	68.0 (20)	58897.95	3.87	57282.18	3.93	49203.32	4.26	44356.00	4.46	41544.96	4.65	30300.81	5.42	32639.96	5.39	38487.84	5.32	40826.99	5.29	36788.40	5.14	30057.43	4.89
	69.8 (21)	58167.81	3.94	56430.35	3.99	47743.04	4.24	42530.65	4.39	39816.96	4.60	28962.22	5.44	30868.69	5.41	35634.88	5.33	37541.36	5.29	34552.35	5.15	29570.67	4.92
	71.6 (22)	57681.05	4.02	56491.20	4.07	50541.91	4.34	46972.33	4.50	43114.76	4.69	27684.47	5.46	30605.03	5.42	37906.43	5.33	40826.99	5.29	36332.07	5.18	28840.53	5.00
	75.2 (24)	57315.98	4.16	55179.65	4.21	44497.97	4.41	38088.97	4.53	35509.14	4.73	25189.83	5.53	28624.19	5.49	37210.09	5.38	40644.46	5.33	35510.66	5.26	26954.33	5.14
2.5 + 2.5	60.8 (16)	42263.87	2.21	41463.31	2.26	37460.55	2.50	35058.89	2.65	32812.86	2.77	23828.77	3.23	24499.63	3.24	26176.76	3.28	26847.62	3.30	24281.60	3.15	20004.90	2.90
	64.4 (18)	40251.30	2.29	39334.47	2.33	34750.29	2.56	31999.79	2.70	29971.12	2.82	21856.46	3.32	22992.44	3.31	25832.39	3.27	26968.37	3.26	24417.45	3.13	20165.90	2.91
	68.0 (20)	38963.26	2.37	37894.37	2.41	32549.89	2.61	29343.20	2.73	27483.59	2.85	20045.15	3.32	21592.59	3.30	25461.19	3.26	27008.62	3.24	24336.94	3.15	19884.14	2.99
	69.8 (21)	38480.25	2.41	37330.85	2.44	31583.86	2.59	28135.66	2.69	26340.45	2.81	19159.62	3.33	20420.83	3.31	23573.85	3.26	24835.05	3.24	22857.71	3.15	19562.13	3.01
	71.6 (22)	38158.24	2.46	37371.10	2.49	33435.42	2.65	31074.01	2.75	28522.07	2.87	18314.34	3.34	20246.41	3.32	25076.56	3.26	27008.62	3.24	24035.06	3.17	19079.12	3.06
	75.2 (24)	37916.73	2.55	36503.46	2.57	29437.12	2.70	25197.32	2.78	23490.66	2.90	16664.04	3.39	18936.00	3.36	24615.91	3.29	26887.87	3.26	23491.67	3.22	17831.33	3.15
2.5 + 3.2	60.8 (16)	49635.47	2.74	48695.29	2.80	43994.36	3.11	41173.81	3.29	38536.04	3.44	27984.95	4.01	28772.82	4.03	30742.48	4.07	31530.34	4.09	28516.76	3.91	23494.12	3.60
	64.4 (18)	47271.88	2.84	46195.13	2.90	40811.39	3.18	37581.14	3.35	35198.64	3.50	25668.63	4.12	27002.75	4.11	30338.04	4.07	31672.16	4.05	28676.30	3.89	23683.21	3.62
	68.0 (20)	45759.18	2.94	44503.85	2.99	38227.19	3.24	34461.20	3.39	32277.24	3.54	23541.40	4.12	25358.74	4.10	29902.09	4.04	31719.43	4.02	28581.76	3.91	23352.31	3.71
	69.8 (21)	45191.92	3.00	43842.04	3.03	37092.67	3.22	33043.04	3.33	30934.72	3.49	22501.41	4.14	23982.60	4.11	27685.56	4.05	29166.75	4.02	26844.52	3.92	22974.13	3.74
	71.6 (22)	44813.74	3.05	43889.31	3.09	39267.17	3.30	36493.89	3.42	33496.85	3.56	21508.71	4.15	23777.76	4.12	29450.38	4.05	31719.43	4.02	28227.22	3.94	22406.87	3.80
	75.2 (24)	44530.11	3.16	42870.34	3.20	34571.50	3.35	29592.20	3.45	27587.87	3.60	19570.56	4.21	22238.79	4.17	28909.38	4.09	31577.62	4.05	27589.05	4.00	20941.44	3.91
2.5 + 5.0	60.8 (16)	49635.47	2.74	48695.29	2.80	43994.36	3.11	41173.81	3.29	38536.04	3.44	27984.95	4.01	28772.82	4.03	30742.48	4.07	31530.34	4.09	28516.76	3.91	23494.12	3.60
	64.4 (18)	47271.88	2.84	46195.13	2.90	40811.39	3.18	37581.14	3.35	35198.64	3.50	25668.63	4.12	27002.75	4.11	30338.04	4.07	31672.16	4.05	28676.30	3.89	23683.21	3.62
	68.0 (20)	45759.18	2.94	44503.85	2.99	38227.19	3.24	34461.20	3.39	32277.24	3.54	23541.40	4.12	25358.74	4.10	29902.09	4.04	31719.43	4.02	28581.76	3.91	23352.31	3.71
	69.8 (21)	45191.92	3.00	43842.04	3.03	37092.67	3.22	33043.04	3.33	30934.72	3.49	22501.41	4.14	23982.60	4.11	27685.56	4.05	29166.75	4.02	26844.52	3.92	22974.13	3.74
	71.6 (22)	44813.74	3.05	43889.31	3.09	39267.17	3.30	36493.89	3.42	33496.85	3.56	21508.71	4.15	23777.76	4.12	29450.38	4.05	31719.43	4.02	28227.22	3.94	22406.87	3.80
	75.2 (24)	44530.11	3.16	42870.34	3.20	34571.50	3.35	29592.20	3.45	27587.87	3.60	19570.56	4.21	22238.79	4.17	28909.38	4.09	31577.62	4.05	27589.05	4.00	20941.44	3.91
2.5 + 7.0	60.8 (16)	63887.24	3.61	62677.10	3.69	56626.41	4.09	52995.99	4.33	49600.84	4.52	36020.24	5.27	37034.32	5.30	39569.53	5.36	40583.61	5.39	36704.74	5.14	30239.96	4.74
	64.4 (18)	60844.99	3.74	59459.08	3.81	52529.51	4.18	48371.77	4.40	45305.18	4.61	33038.83	5.42	34756.01	5.40	39048.96	5.35	40766.15	5.33	36910.09	5.11	30483.34	4.76
	68.0 (20)	58897.95	3.87	57282.18	3.93	49203.32	4.26	44356.00	4.46	41544.96	4.65	30300.81	5.42	32639.96	5.39	38487.84	5.32	40826.99	5.29	36788.40	5.14	30057.43	4.89
	69.8 (21)	58167.81	3.94	56430.35	3.99	47743.04	4.24	42530.65	4.39	39816.96	4.60	28962.22	5.44	30868.69	5.41	35634.88	5.33	37541.36	5.29	34552.35	5.15	29570.67	4.92
	71.6 (22)	57681.05	4.02	56491.20	4.07	50541.91	4.34	46972.33	4.50	43114.76	4.69	27684.47	5.46	30605.03	5.42	37906.43	5.33	40826.99	5.29	36332.07	5.18	28840.53	5.00
	75.2 (24)	57315.98	4.16	55179.65	4.21	44497.97	4.41	38088.97	4.53	35509.14	4.73	25189.83	5.53	28624.19	5.49	37210.09	5.38	40644.46	5.33	35510.66	5.26	26954.33	5.14

Combination (Capacity)	Indoor Air Temp. °F (°C) DB	Outdoor Air Temp. °F (°C) WB																					
		60.8 (16)		59.0 (15)		50.0 (10)		44.6 (7)		42.8 (6)		35.6 (2)		32.0 (0)		23.0 (-5)		19.4 (-7)		14.0 (-10)		5.0 (-15)	
		Total Capacity (BTU/h)	Input Power (kW)	Total Capacity (BTU/h)	Input Power (kW)	Total Capacity (BTU/h)	Input Power (kW)	Total Capacity (BTU/h)	Input Power (kW)	Total Capacity (BTU/h)	Input Power (kW)	Total Capacity (BTU/h)	Input Power (kW)	Total Capacity (BTU/h)	Input Power (kW)	Total Capacity (BTU/h)	Input Power (kW)	Total Capacity (BTU/h)	Input Power (kW)	Total Capacity (BTU/h)	Input Power (kW)	Total Capacity (BTU/h)	Input Power (kW)
3.2 + 3.2	60.8 (16)	54058.44	3.09	53034.47	3.16	47914.65	3.50	44842.76	3.71	41969.94	3.87	30478.66	4.52	31336.73	4.54	33481.91	4.59	34339.98	4.61	31057.86	4.40	25587.66	4.06
	64.4 (18)	51484.22	3.20	50311.53	3.27	44448.05	3.58	40929.96	3.77	38335.15	3.95	27955.93	4.64	29408.93	4.63	33041.43	4.58	34494.43	4.56	31231.62	4.38	25793.60	4.07
	68.0 (20)	49836.73	3.31	48469.54	3.37	41633.58	3.65	37532.00	3.82	35153.43	3.98	25639.14	4.64	27618.43	4.62	32566.63	4.56	34545.91	4.53	31128.65	4.40	25433.21	4.18
	69.8 (21)	49218.92	3.38	47748.76	3.42	40397.96	3.63	35987.47	3.76	33691.28	3.94	24506.49	4.66	26119.66	4.63	30152.59	4.56	31765.77	4.53	29236.60	4.41	25021.33	4.22
	71.6 (22)	48807.05	3.44	47800.24	3.49	42766.23	3.71	39745.82	3.85	36481.72	4.02	23425.32	4.68	25896.57	4.64	32074.67	4.56	34545.91	4.53	30742.52	4.44	24403.52	4.28
	75.2 (24)	48498.14	3.57	46690.47	3.60	37652.13	3.78	32229.12	3.88	30046.19	4.05	21314.47	4.74	24220.47	4.70	31485.46	4.60	34391.46	4.56	30047.48	4.51	22807.51	4.41
3.2 + 5.0	60.8 (16)	58481.40	3.12	57373.66	3.18	51834.94	3.53	48511.71	3.74	45403.84	3.90	32972.37	4.55	33900.65	4.57	36221.34	4.63	37149.61	4.65	33598.96	4.44	27681.20	4.09
	64.4 (18)	55696.57	3.23	54427.93	3.29	48084.71	3.61	44278.77	3.80	41471.67	3.98	30243.24	4.68	31815.12	4.66	35744.82	4.62	37316.70	4.60	33786.93	4.42	27903.98	4.11
	68.0 (20)	53914.28	3.34	52435.23	3.40	45039.96	3.68	40602.80	3.85	38029.62	4.02	27736.89	4.68	29878.12	4.66	35231.18	4.59	37372.40	4.57	33675.54	4.44	27514.11	4.22
	69.8 (21)	53245.92	3.40	51655.48	3.45	43703.24	3.66	38931.90	3.79	36447.84	3.97	26511.57	4.70	28256.73	4.67	32619.62	4.60	34364.78	4.57	31628.69	4.45	27068.53	4.25
	71.6 (22)	52800.35	3.47	51711.17	3.51	46265.28	3.74	42997.75	3.88	39466.59	4.05	25341.94	4.71	28015.38	4.68	34698.96	4.60	37372.40	4.57	33257.81	4.47	26400.17	4.31
	75.2 (24)	52466.17	3.59	50510.60	3.63	40732.76	3.81	34866.05	3.91	32504.52	4.09	23058.38	4.78	26202.14	4.74	34061.55	4.64	37205.31	4.60	32505.91	4.54	24673.58	4.44
3.2 + 7.0	60.8 (16)	67818.77	3.87	66534.16	3.95	60111.11	4.38	56257.28	4.64	52653.20	4.84	38236.87	5.65	39313.35	5.68	42004.58	5.75	43081.06	5.77	38963.50	5.51	32100.88	5.08
	64.4 (18)	64589.30	4.01	63118.10	4.09	55762.10	4.48	51348.49	4.72	48093.19	4.94	35071.99	5.81	36894.84	5.79	41451.98	5.73	43274.83	5.71	39181.48	5.48	32359.24	5.10
	68.0 (20)	62522.44	4.15	60807.24	4.22	52231.21	4.57	47085.60	4.78	44101.57	4.99	32165.47	5.81	34648.57	5.78	40856.32	5.70	43339.42	5.67	39052.31	5.51	31907.11	5.24
	69.8 (21)	61747.37	4.22	59902.99	4.28	50681.07	4.54	45147.92	4.70	42267.24	4.93	30744.51	5.83	32768.31	5.80	37827.80	5.71	39851.60	5.67	36678.65	5.52	31390.40	5.28
	71.6 (22)	61230.66	4.30	59967.58	4.36	53652.18	4.65	49862.94	4.82	45767.98	5.03	29388.13	5.85	32488.42	5.81	40239.13	5.71	43339.42	5.67	38567.89	5.55	30615.33	5.36
	75.2 (24)	60843.12	4.46	58575.32	4.51	47236.31	4.73	40432.90	4.86	37694.32	5.07	26739.97	5.93	30385.68	5.88	39499.95	5.76	43145.65	5.71	37695.93	5.64	28613.06	5.51
5.0 + 5.0	60.8 (16)	67818.77	3.67	66534.16	3.75	60111.11	4.15	56257.28	4.40	52653.20	4.59	38236.87	5.36	39313.35	5.38	42004.58	5.44	43081.06	5.47	38963.50	5.22	32100.88	4.81
	64.4 (18)	64589.30	3.80	63118.10	3.87	55762.10	4.25	51348.49	4.47	48093.19	4.68	35071.99	5.51	36894.84	5.49	41451.98	5.43	43274.83	5.41	39181.48	5.19	32359.24	4.83
	68.0 (20)	62522.44	3.93	60807.24	4.00	52231.21	4.33	47085.60	4.53	44101.57	4.73	32165.47	5.51	34648.57	5.48	40856.32	5.41	43339.42	5.38	39052.31	5.22	31907.11	4.96
	69.8 (21)	61747.37	4.00	59902.99	4.05	50681.07	4.31	45147.92	4.46	42267.24	4.67	30744.51	5.53	32768.31	5.49	37827.80	5.41	39851.60	5.38	36678.65	5.23	31390.40	5.00
	71.6 (22)	61230.66	4.08	59967.58	4.13	53652.18	4.40	49862.94	4.57	45767.98	4.76	29388.13	5.55	32488.42	5.51	40239.13	5.41	43339.42	5.38	38567.89	5.26	30615.33	5.08
	75.2 (24)	60843.12	4.23	58575.32	4.27	47236.31	4.48	40432.90	4.61	37694.32	4.81	26739.97	5.62	30385.68	5.57	39499.95	5.46	43145.65	5.41	37695.93	5.34	28613.06	5.23
5.0 + 7.0	60.8 (16)	67818.77	3.65	66534.16	3.73	60111.11	4.14	56257.28	4.38	52653.20	4.57	38236.87	5.33	39313.35	5.36	42004.58	5.42	43081.06	5.45	38963.50	5.20	32100.88	4.79
	64.4 (18)	64589.30	3.78	63118.10	3.86	55762.10	4.23	51348.49	4.45	48093.19	4.66	35071.99	5.48	36894.84	5.46	41451.98	5.41	43274.83	5.39	39181.48	5.17	32359.24	4.81
	68.0 (20)	62522.44	3.91	60807.24	3.98	52231.21	4.31	47085.60	4.51	44101.57	4.70	32165.47	5.48	34648.57	5.45	40856.32	5.38	43339.42	5.35	39052.31	5.20	31907.11	4.94
	69.8 (21)	61747.37	3.99	59902.99	4.04	50681.07	4.29	45147.92	4.44	42267.24	4.65	30744.51	5.50	32768.31	5.47	37827.80	5.39	39851.60	5.35	36678.65	5.21	31390.40	4.98
	71.6 (22)	61230.66	4.06	59967.58	4.11	53652.18	4.39	49862.94	4.55	45767.98	4.74	29388.13	5.52	32488.42	5.48	40239.13	5.39	43339.42	5.35	38567.89	5.24	30615.33	5.05
	75.2 (24)	60843.12	4.21	58575.32	4.25	47236.31	4.46	40432.90	4.58	37694.32	4.79	26739.97	5.60	30385.68	5.55	39499.95	5.44	43145.65	5.39	37695.93	5.32	28613.06	5.20
1.6 + 1.6 + 1.6	60.8 (16)	60447.16	3.23	59302.18	3.30	53577.29	3.66	50142.36	3.87	46930.02	4.04	34080.68	4.72	35040.16	4.74	37438.86	4.80	38398.34	4.82	34728.33	4.60	28611.66	4.24
	64.4 (18)	57568.72	3.34	56257.44	3.41	49701.00	3.74	45767.14	3.94	42865.67	4.12	31259.82	4.85	32884.53	4.83	36946.33	4.79	38571.05	4.77	34922.63	4.58	28841.93	4.25
	68.0 (20)	55726.53	3.46	54197.76	3.52	46553.91	3.81	41967.60	3.99	39307.92	4.16	28669.22	4.85	30882.42	4.83	36415.42	4.76	38628.61	4.74	34807.49	4.60	28438.95	4.37
	69.8 (21)	55035.70	3.53	53391.79	3.57	45172.26	3.79	40240.54	3.92	37672.97	4.11	27402.71	4.87	29206.53	4.84	33716.08	4.76	35519.90	4.74	32691.84	4.61	27978.40	4.40
	71.6 (22)	54575.15	3.59	53449.36	3.64	47820.42	3.88	44443.06	4.02	40793.20	4.20	26193.77	4.88	28957.07	4.85	35865.32	4.77	38628.61	4.74	34375.72	4.64	27287.58	4.47
	75.2 (24)	54229.74	3.73	52208.44	3.76	42101.93	3.95	36038.02	4.06	33597.11	4.24	23833.45	4.95	27082.89	4.91	35206.47	4.81	38455.91	4.77	33598.55	4.71	25502.94	4.60

Combination (Capacity)	Indoor Air Temp. °F (°C) DB	Outdoor Air Temp. °F (°C) WB																					
		60.8 (16)		59.0 (15)		50.0 (10)		44.6 (7)		42.8 (6)		35.6 (2)		32.0 (0)		23.0 (-5)		19.4 (-7)		14.0 (-10)		5.0 (-15)	
		Total Capacity (BTU/h)	Input Power (kW)	Total Capacity (BTU/h)	Input Power (kW)	Total Capacity (BTU/h)	Input Power (kW)	Total Capacity (BTU/h)	Input Power (kW)	Total Capacity (BTU/h)	Input Power (kW)	Total Capacity (BTU/h)	Input Power (kW)	Total Capacity (BTU/h)	Input Power (kW)	Total Capacity (BTU/h)	Input Power (kW)	Total Capacity (BTU/h)	Input Power (kW)	Total Capacity (BTU/h)	Input Power (kW)	Total Capacity (BTU/h)	Input Power (kW)
1.6 + 1.6 + 2.0	60.8 (16)	60447.16	3.22	59302.18	3.29	53577.29	3.65	50142.36	3.86	46930.02	4.03	34080.68	4.71	35040.16	4.73	37438.86	4.78	38398.34	4.81	34728.33	4.59	28611.66	4.23
	64.4 (18)	57568.72	3.34	56257.44	3.40	49701.00	3.73	45767.14	3.93	42865.67	4.11	31259.82	4.84	32884.53	4.82	36946.33	4.77	38571.05	4.76	34922.63	4.56	28841.93	4.24
	68.0 (20)	55726.53	3.45	54197.76	3.51	46553.91	3.80	41967.60	3.98	39307.92	4.15	28669.22	4.84	30882.42	4.81	36415.42	4.75	38628.61	4.72	34807.49	4.59	28438.95	4.36
	69.8 (21)	55035.70	3.52	53391.79	3.56	45172.26	3.78	40240.54	3.92	37672.97	4.10	27402.71	4.86	29206.53	4.83	33716.08	4.75	35519.90	4.72	32691.84	4.60	27978.40	4.39
	71.6 (22)	54575.15	3.58	53449.36	3.63	47820.42	3.87	44443.06	4.01	40793.20	4.18	26193.77	4.87	28957.07	4.84	35865.32	4.76	38628.61	4.72	34375.72	4.62	27287.58	4.46
	75.2 (24)	54229.74	3.72	52208.44	3.75	42101.93	3.94	36038.02	4.05	33597.11	4.22	23833.45	4.94	27082.89	4.90	35206.47	4.80	38455.91	4.76	33598.55	4.69	25502.94	4.59
1.6 + 1.6 + 2.5	60.8 (16)	60447.16	3.22	59302.18	3.29	53577.29	3.65	50142.36	3.86	46930.02	4.03	34080.68	4.71	35040.16	4.73	37438.86	4.78	38398.34	4.81	34728.33	4.59	28611.66	4.23
	64.4 (18)	57568.72	3.34	56257.44	3.40	49701.00	3.73	45767.14	3.93	42865.67	4.11	31259.82	4.84	32884.53	4.82	36946.33	4.77	38571.05	4.76	34922.63	4.56	28841.93	4.24
	68.0 (20)	55726.53	3.45	54197.76	3.51	46553.91	3.80	41967.60	3.98	39307.92	4.15	28669.22	4.84	30882.42	4.81	36415.42	4.75	38628.61	4.72	34807.49	4.59	28438.95	4.36
	69.8 (21)	55035.70	3.52	53391.79	3.56	45172.26	3.78	40240.54	3.92	37672.97	4.10	27402.71	4.86	29206.53	4.83	33716.08	4.75	35519.90	4.72	32691.84	4.60	27978.40	4.39
	71.6 (22)	54575.15	3.58	53449.36	3.63	47820.42	3.87	44443.06	4.01	40793.20	4.18	26193.77	4.87	28957.07	4.84	35865.32	4.76	38628.61	4.72	34375.72	4.62	27287.58	4.46
	75.2 (24)	54229.74	3.72	52208.44	3.75	42101.93	3.94	36038.02	4.05	33597.11	4.22	23833.45	4.94	27082.89	4.90	35206.47	4.80	38455.91	4.76	33598.55	4.69	25502.94	4.59
1.6 + 1.6 + 3.2	60.8 (16)	60447.16	3.15	59302.18	3.22	53577.29	3.57	50142.36	3.78	46930.02	3.94	34080.68	4.60	35040.16	4.62	37438.86	4.68	38398.34	4.70	34728.33	4.49	28611.66	4.13
	64.4 (18)	57568.72	3.26	56257.44	3.33	49701.00	3.65	45767.14	3.84	42865.67	4.02	31259.82	4.73	32884.53	4.71	36946.33	4.67	38571.05	4.65	34922.63	4.46	28841.93	4.15
	68.0 (20)	55726.53	3.37	54197.76	3.43	46553.91	3.72	41967.60	3.89	39307.92	4.06	28669.22	4.73	30882.42	4.70	36415.42	4.64	38628.61	4.62	34807.49	4.48	28438.95	4.26
	69.8 (21)	55035.70	3.44	53391.79	3.48	45172.26	3.70	40240.54	3.83	37672.97	4.01	27402.71	4.75	29206.53	4.72	33716.08	4.65	35519.90	4.62	32691.84	4.50	27978.40	4.29
	71.6 (22)	54575.15	3.50	53449.36	3.55	47820.42	3.78	44443.06	3.92	40793.20	4.09	26193.77	4.76	28957.07	4.73	35865.32	4.65	38628.61	4.62	34375.72	4.52	27287.58	4.36
	75.2 (24)	54229.74	3.63	52208.44	3.67	42101.93	3.85	36038.02	3.95	33597.11	4.13	23833.45	4.83	27082.89	4.79	35206.47	4.69	38455.91	4.65	33598.55	4.59	25502.94	4.49
1.6 + 1.6 + 5.0	60.8 (16)	63395.80	3.22	62194.97	3.29	56190.82	3.65	52588.33	3.86	49219.29	4.03	35743.16	4.71	36749.44	4.73	39265.15	4.78	40271.43	4.81	36422.40	4.59	30007.35	4.23
	64.4 (18)	60376.95	3.34	59001.70	3.40	52125.44	3.73	47999.68	3.93	44956.68	4.11	32784.69	4.84	34488.66	4.82	38748.59	4.77	40452.56	4.76	36626.17	4.56	30248.85	4.24
	68.0 (20)	58444.89	3.45	56841.55	3.51	48824.83	3.80	44014.80	3.98	41225.38	4.15	30067.72	4.84	32388.88	4.81	38191.78	4.75	40512.94	4.72	36505.42	4.59	29826.22	4.36
	69.8 (21)	57720.37	3.52	55996.27	3.56	47375.78	3.78	42203.49	3.92	39510.68	4.10	28739.43	4.86	30631.24	4.83	35360.77	4.75	37252.58	4.72	34286.56	4.60	29343.20	4.39
	71.6 (22)	57237.35	3.58	56056.65	3.63	50153.12	3.87	46611.01	4.01	42783.11	4.18	27471.51	4.87	30369.61	4.84	37614.84	4.76	40512.94	4.72	36052.59	4.62	28618.68	4.46
	75.2 (24)	56875.09	3.72	54755.19	3.75	44155.68	3.94	37795.97	4.05	35235.99	4.22	24996.06	4.94	28404.00	4.90	36923.86	4.80	40331.81	4.76	35237.50	4.69	26746.99	4.59
1.6 + 1.6 + 7.0	60.8 (16)	66835.88	3.50	65569.89	3.58	59239.93	3.97	55441.96	4.20	51890.11	4.39	37682.71	5.12	38743.60	5.14	41395.81	5.20	42456.70	5.23	38398.81	4.99	31635.65	4.60
	64.4 (18)	63653.22	3.63	62203.34	3.70	54953.95	4.06	50604.31	4.28	47396.19	4.47	34563.70	5.26	36360.14	5.24	40851.22	5.19	42647.66	5.17	38613.64	4.97	31890.27	4.62
	68.0 (20)	61616.32	3.76	59925.97	3.82	51474.24	4.14	46403.20	4.33	43462.42	4.52	31699.31	5.26	34146.42	5.24	40264.20	5.17	42711.31	5.14	38486.33	4.99	31444.69	4.74
	69.8 (21)	60852.48	3.83	59034.83	3.87	49946.56	4.12	44493.60	4.26	41654.67	4.46	30298.93	5.28	32293.40	5.25	37279.57	5.17	39274.04	5.14	36147.07	5.00	30935.47	4.78
	71.6 (22)	60343.26	3.90	59098.48	3.95	52874.61	4.21	49140.29	4.37	45104.67	4.55	28962.22	5.30	32017.57	5.26	39655.96	5.17	42711.31	5.14	38008.93	5.03	30171.63	4.85
	75.2 (24)	59961.34	4.04	57726.40	4.08	46551.72	4.28	39846.92	4.40	37148.02	4.60	26352.43	5.37	29945.31	5.33	38927.48	5.22	42520.35	5.17	37149.61	5.11	28198.38	4.99
1.6 + 2.0 + 2.0	60.8 (16)	60447.16	3.16	59302.18	3.23	53577.29	3.59	50142.36	3.80	46930.02	3.96	34080.68	4.62	35040.16	4.65	37438.86	4.70	38398.34	4.72	34728.33	4.51	28611.66	4.15
	64.4 (18)	57568.72	3.28	56257.44	3.34	49701.00	3.67	45767.14	3.86	42865.67	4.04	31259.82	4.75	32884.53	4.74	36946.33	4.69	38571.05	4.67	34922.63	4.48	28841.93	4.17
	68.0 (20)	55726.53	3.39	54197.76	3.45	46553.91	3.74	41967.60	3.91	39307.92	4.08	28669.22	4.75	30882.42	4.73	36415.42	4.67	38628.61	4.64	34807.49	4.51	28438.95	4.28
	69.8 (21)	55035.70	3.46	53391.79	3.50	45172.26	3.72	40240.54	3.85	37672.97	4.03	27402.71	4.77	29206.53	4.74	33716.08	4.67	35519.90	4.64	32691.84	4.52	27978.40	4.32
	71.6 (22)	54575.15	3.52	53449.36	3.57	47820.42	3.80	44443.06	3.94	40793.20	4.11	26193.77	4.79	28957.07	4.75	35865.32	4.67	38628.61	4.64	34375.72	4.54	27287.58	4.38
	75.2 (24)	54229.74	3.65	52208.44	3.69	42101.93	3.87	36038.02	3.97	33597.11	4.15	23833.45	4.85	27082.89	4.81	35206.47	4.71	38455.91	4.67	33598.55	4.61	25502.94	4.51

Combination (Capacity)	Indoor Air Temp. °F (°C) DB	Outdoor Air Temp. °F (°C) WB																					
		60.8 (16)		59.0 (15)		50.0 (10)		44.6 (7)		42.8 (6)		35.6 (2)		32.0 (0)		23.0 (-5)		19.4 (-7)		14.0 (-10)		5.0 (-15)	
		Total Capacity (BTU/h)	Input Power (kW)	Total Capacity (BTU/h)	Input Power (kW)	Total Capacity (BTU/h)	Input Power (kW)	Total Capacity (BTU/h)	Input Power (kW)	Total Capacity (BTU/h)	Input Power (kW)	Total Capacity (BTU/h)	Input Power (kW)	Total Capacity (BTU/h)	Input Power (kW)	Total Capacity (BTU/h)	Input Power (kW)	Total Capacity (BTU/h)	Input Power (kW)	Total Capacity (BTU/h)	Input Power (kW)	Total Capacity (BTU/h)	Input Power (kW)
1.6 + 2.0 + 2.5	60.8 (16)	60447.16	3.16	59302.18	3.23	53577.29	3.59	50142.36	3.80	46930.02	3.96	34080.68	4.62	35040.16	4.65	37438.86	4.70	38398.34	4.72	34728.33	4.51	28611.66	4.15
	64.4 (18)	57568.72	3.28	56257.44	3.34	49701.00	3.67	45767.14	3.86	42865.67	4.04	31259.82	4.75	32884.53	4.74	36946.33	4.69	38571.05	4.67	34922.63	4.48	28841.93	4.17
	68.0 (20)	55726.53	3.39	54197.76	3.45	46553.91	3.74	41967.60	3.91	39307.92	4.08	28669.22	4.75	30882.42	4.73	36415.42	4.67	38628.61	4.64	34807.49	4.51	28438.95	4.28
	69.8 (21)	55035.70	3.46	53391.79	3.50	45172.26	3.72	40240.54	3.85	37672.97	4.03	27402.71	4.77	29206.53	4.74	33716.08	4.67	35519.90	4.64	32691.84	4.52	27978.40	4.32
	71.6 (22)	54575.15	3.52	53449.36	3.57	47820.42	3.80	44443.06	3.94	40793.20	4.11	26193.77	4.79	28957.07	4.75	35865.32	4.67	38628.61	4.64	34375.72	4.54	27287.58	4.38
	75.2 (24)	54229.74	3.65	52208.44	3.69	42101.93	3.87	36038.02	3.97	33597.11	4.15	23833.45	4.85	27082.89	4.81	35206.47	4.71	38455.91	4.67	33598.55	4.61	25502.94	4.51
1.6 + 2.0 + 3.2	60.8 (16)	60447.16	3.14	59302.18	3.21	53577.29	3.56	50142.36	3.77	46930.02	3.93	34080.68	4.59	35040.16	4.61	37438.86	4.66	38398.34	4.68	34728.33	4.47	28611.66	4.12
	64.4 (18)	57568.72	3.25	56257.44	3.32	49701.00	3.64	45767.14	3.83	42865.67	4.01	31259.82	4.72	32884.53	4.70	36946.33	4.65	38571.05	4.64	34922.63	4.45	28841.93	4.14
	68.0 (20)	55726.53	3.36	54197.76	3.42	46553.91	3.71	41967.60	3.88	39307.92	4.05	28669.22	4.72	30882.42	4.69	36415.42	4.63	38628.61	4.60	34807.49	4.47	28438.95	4.25
	69.8 (21)	55035.70	3.43	53391.79	3.47	45172.26	3.69	40240.54	3.82	37672.97	4.00	27402.71	4.73	29206.53	4.70	33716.08	4.63	35519.90	4.60	32691.84	4.48	27978.40	4.28
	71.6 (22)	54575.15	3.49	53449.36	3.54	47820.42	3.77	44443.06	3.91	40793.20	4.08	26193.77	4.75	28957.07	4.72	35865.32	4.64	38628.61	4.60	34375.72	4.51	27287.58	4.35
	75.2 (24)	54229.74	3.62	52208.44	3.66	42101.93	3.84	36038.02	3.94	33597.11	4.12	23833.45	4.81	27082.89	4.77	35206.47	4.68	38455.91	4.64	33598.55	4.58	25502.94	4.48
1.6 + 2.0 + 5.0	60.8 (16)	66835.88	3.51	65569.89	3.59	59239.93	3.98	55441.96	4.21	51890.11	4.40	37682.71	5.13	38743.60	5.16	41395.81	5.22	42456.70	5.24	38398.81	5.00	31635.65	4.61
	64.4 (18)	63653.22	3.64	62203.34	3.71	54953.95	4.07	50604.31	4.29	47396.19	4.48	34563.70	5.28	36360.14	5.26	40851.22	5.21	42647.66	5.19	38613.64	4.98	31890.27	4.63
	68.0 (20)	61616.32	3.76	59925.97	3.83	51474.24	4.15	46403.20	4.34	43462.42	4.53	31699.31	5.28	34146.42	5.25	40264.20	5.18	42711.31	5.15	38486.33	5.00	31444.69	4.75
	69.8 (21)	60852.48	3.84	59034.83	3.88	49946.56	4.12	44493.60	4.27	41654.67	4.47	30298.93	5.29	32293.40	5.26	37279.57	5.18	39274.04	5.15	36147.07	5.02	30935.47	4.79
	71.6 (22)	60343.26	3.91	59098.48	3.96	52874.61	4.22	49140.29	4.38	45104.67	4.56	28962.22	5.31	32017.57	5.28	39655.96	5.19	42711.31	5.15	38008.93	5.04	30171.63	4.86
	75.2 (24)	59961.34	4.05	57726.40	4.09	46551.72	4.29	39846.92	4.41	37148.02	4.61	26352.43	5.38	29945.31	5.34	38927.48	5.23	42520.35	5.19	37149.61	5.12	28198.38	5.01
1.6 + 2.0 + 7.0	60.8 (16)	67818.77	3.54	66534.16	3.62	60111.11	4.02	56257.28	4.25	52653.20	4.44	38236.87	5.18	39313.35	5.20	42004.58	5.26	43081.06	5.29	38963.50	5.05	32100.88	4.65
	64.4 (18)	64589.30	3.67	63118.10	3.74	55762.10	4.11	51348.49	4.33	48093.19	4.53	35071.99	5.33	36894.84	5.30	41451.98	5.25	43274.83	5.23	39181.48	5.02	32359.24	4.67
	68.0 (20)	62522.44	3.80	60807.24	3.86	52231.21	4.19	47085.60	4.38	44101.57	4.57	32165.47	5.33	34648.57	5.30	40856.32	5.23	43339.42	5.20	39052.31	5.05	31907.11	4.80
	69.8 (21)	61747.37	3.87	59902.99	3.92	50681.07	4.16	45147.92	4.31	42267.24	4.52	30744.51	5.34	32768.31	5.31	37827.80	5.23	39851.60	5.20	36678.65	5.06	31390.40	4.83
	71.6 (22)	61230.66	3.94	59967.58	4.00	53652.18	4.26	49862.94	4.42	45767.98	4.61	29388.13	5.36	32488.42	5.33	40239.13	5.23	43339.42	5.20	38567.89	5.09	30615.33	4.91
	75.2 (24)	60843.12	4.09	58575.32	4.13	47236.31	4.33	40432.90	4.45	37694.32	4.65	26739.97	5.43	30385.68	5.39	39499.95	5.28	43145.65	5.23	37695.93	5.17	28613.06	5.05
1.6 + 2.5 + 2.5	60.8 (16)	60447.16	3.16	59302.18	3.23	53577.29	3.59	50142.36	3.80	46930.02	3.96	34080.68	4.62	35040.16	4.65	37438.86	4.70	38398.34	4.72	34728.33	4.51	28611.66	4.15
	64.4 (18)	57568.72	3.28	56257.44	3.34	49701.00	3.67	45767.14	3.86	42865.67	4.04	31259.82	4.75	32884.53	4.74	36946.33	4.69	38571.05	4.67	34922.63	4.48	28841.93	4.17
	68.0 (20)	55726.53	3.39	54197.76	3.45	46553.91	3.74	41967.60	3.91	39307.92	4.08	28669.22	4.75	30882.42	4.73	36415.42	4.67	38628.61	4.64	34807.49	4.51	28438.95	4.28
	69.8 (21)	55035.70	3.46	53391.79	3.50	45172.26	3.72	40240.54	3.85	37672.97	4.03	27402.71	4.77	29206.53	4.74	33716.08	4.67	35519.90	4.64	32691.84	4.52	27978.40	4.32
	71.6 (22)	54575.15	3.52	53449.36	3.57	47820.42	3.80	44443.06	3.94	40793.20	4.11	26193.77	4.79	28957.07	4.75	35865.32	4.67	38628.61	4.64	34375.72	4.54	27287.58	4.38
	75.2 (24)	54229.74	3.65	52208.44	3.69	42101.93	3.87	36038.02	3.97	33597.11	4.15	23833.45	4.85	27082.89	4.81	35206.47	4.71	38455.91	4.67	33598.55	4.61	25502.94	4.51
1.6 + 2.5 + 3.2	60.8 (16)	60447.16	3.14	59302.18	3.21	53577.29	3.56	50142.36	3.77	46930.02	3.93	34080.68	4.59	35040.16	4.61	37438.86	4.66	38398.34	4.68	34728.33	4.47	28611.66	4.12
	64.4 (18)	57568.72	3.25	56257.44	3.32	49701.00	3.64	45767.14	3.83	42865.67	4.01	31259.82	4.72	32884.53	4.70	36946.33	4.65	38571.05	4.64	34922.63	4.45	28841.93	4.14
	68.0 (20)	55726.53	3.36	54197.76	3.42	46553.91	3.71	41967.60	3.88	39307.92	4.05	28669.22	4.72	30882.42	4.69	36415.42	4.63	38628.61	4.60	34807.49	4.47	28438.95	4.25
	69.8 (21)	55035.70	3.43	53391.79	3.47	45172.26	3.69	40240.54	3.82	37672.97	4.00	27402.71	4.73	29206.53	4.70	33716.08	4.63	35519.90	4.60	32691.84	4.48	27978.40	4.28
	71.6 (22)	54575.15	3.49	53449.36	3.54	47820.42	3.77	44443.06	3.91	40793.20	4.08	26193.77	4.75	28957.07	4.72	35865.32	4.64	38628.61	4.60	34375.72	4.51	27287.58	4.35
	75.2 (24)	54229.74	3.62	52208.44	3.66	42101.93	3.84	36038.02	3.94	33597.11	4.12	23833.45	4.81	27082.89	4.77	35206.47	4.68	38455.91	4.64	33598.55	4.58	25502.94	4.48

Combination (Capacity)	Indoor Air Temp. °F (°C) DB	Outdoor Air Temp. °F (°C) WB																					
		60.8 (16)		59.0 (15)		50.0 (10)		44.6 (7)		42.8 (6)		35.6 (2)		32.0 (0)		23.0 (-5)		19.4 (-7)		14.0 (-10)		5.0 (-15)	
		Total Capacity (BTU/h)	Input Power (kW)	Total Capacity (BTU/h)	Input Power (kW)	Total Capacity (BTU/h)	Input Power (kW)	Total Capacity (BTU/h)	Input Power (kW)	Total Capacity (BTU/h)	Input Power (kW)	Total Capacity (BTU/h)	Input Power (kW)	Total Capacity (BTU/h)	Input Power (kW)	Total Capacity (BTU/h)	Input Power (kW)	Total Capacity (BTU/h)	Input Power (kW)	Total Capacity (BTU/h)	Input Power (kW)	Total Capacity (BTU/h)	Input Power (kW)
1.6 + 2.5 + 5.0	60.8 (16)	66835.88	3.51	65569.89	3.59	59239.93	3.98	55441.96	4.21	51890.11	4.40	37682.71	5.13	38743.60	5.16	41395.81	5.22	42456.70	5.24	38398.81	5.00	31635.65	4.61
	64.4 (18)	63653.22	3.64	62203.34	3.71	54953.95	4.07	50604.31	4.29	47396.19	4.48	34563.70	5.28	36360.14	5.26	40851.22	5.21	42647.66	5.19	38613.64	4.98	31890.27	4.63
	68.0 (20)	61616.32	3.76	59925.97	3.83	51474.24	4.15	46403.20	4.34	43462.42	4.53	31699.31	5.28	34146.42	5.25	40264.20	5.18	42711.31	5.15	38486.33	5.00	31444.69	4.75
	69.8 (21)	60852.48	3.84	59034.83	3.88	49946.56	4.12	44493.60	4.27	41654.67	4.47	30298.93	5.29	32293.40	5.26	37279.57	5.18	39274.04	5.15	36147.07	5.02	30935.47	4.79
	71.6 (22)	60343.26	3.91	59098.48	3.96	52874.61	4.22	49140.29	4.38	45104.67	4.56	28962.22	5.31	32017.57	5.28	39655.96	5.19	42711.31	5.15	38008.93	5.04	30171.63	4.86
	75.2 (24)	59961.34	4.05	57726.40	4.09	46551.72	4.29	39846.92	4.41	37148.02	4.61	26352.43	5.38	29945.31	5.34	38927.48	5.23	42520.35	5.19	37149.61	5.12	28198.38	5.01
1.6 + 2.5 + 7.0	60.8 (16)	67818.77	3.54	66534.16	3.62	60111.11	4.02	56257.28	4.25	52653.20	4.44	38236.87	5.18	39313.35	5.20	42004.58	5.26	43081.06	5.29	38963.50	5.05	32100.88	4.65
	64.4 (18)	64589.30	3.67	63118.10	3.74	55762.10	4.11	51348.49	4.33	48093.19	4.53	35071.99	5.33	36894.84	5.30	41451.98	5.25	43274.83	5.23	39181.48	5.02	32359.24	4.67
	68.0 (20)	62522.44	3.80	60807.24	3.86	52231.21	4.19	47085.60	4.38	44101.57	4.57	32165.47	5.33	34648.57	5.30	40856.32	5.23	43339.42	5.20	39052.31	5.05	31907.11	4.80
	69.8 (21)	61747.37	3.87	59902.99	3.92	50681.07	4.16	45147.92	4.31	42267.24	4.52	30744.51	5.34	32768.31	5.31	37827.80	5.23	39851.60	5.20	36678.65	5.06	31390.40	4.83
	71.6 (22)	61230.66	3.94	59967.58	4.00	53652.18	4.26	49862.94	4.42	45767.98	4.61	29388.13	5.36	32488.42	5.33	40239.13	5.23	43339.42	5.20	38567.89	5.09	30615.33	4.91
	75.2 (24)	60843.12	4.09	58575.32	4.13	47236.31	4.33	40432.90	4.45	37694.32	4.65	26739.97	5.43	30385.68	5.39	39499.95	5.28	43145.65	5.23	37695.93	5.17	28613.06	5.05
1.6 + 3.2 + 3.2	60.8 (16)	63395.80	3.36	62194.97	3.43	56190.82	3.81	52588.33	4.03	49219.29	4.21	35743.16	4.91	36749.44	4.93	39265.15	4.99	40271.43	5.01	36422.40	4.78	30007.35	4.41
	64.4 (18)	60376.95	3.48	59001.70	3.55	52125.44	3.89	47999.68	4.10	44956.68	4.29	32784.69	5.05	34488.66	5.03	38748.59	4.98	40452.56	4.96	36626.17	4.76	30248.85	4.43
	68.0 (20)	58444.89	3.60	56841.55	3.66	48824.83	3.97	44014.80	4.15	41225.38	4.33	30067.72	5.05	32388.88	5.02	38191.78	4.95	40512.94	4.92	36505.42	4.78	29826.22	4.55
	69.8 (21)	57720.37	3.67	55996.27	3.71	47375.78	3.94	42203.49	4.08	39510.68	4.28	28739.43	5.06	30631.24	5.03	35360.77	4.96	37252.58	4.92	34286.56	4.80	29343.20	4.58
	71.6 (22)	57237.35	3.74	56056.65	3.79	50153.12	4.04	46611.01	4.18	42783.11	4.36	27471.51	5.08	30369.61	5.05	37614.84	4.96	40512.94	4.92	36052.59	4.82	28618.68	4.65
	75.2 (24)	56875.09	3.87	54755.19	3.91	44155.68	4.10	37795.97	4.22	35235.99	4.40	24996.06	5.15	28404.00	5.11	36923.86	5.00	40331.81	4.96	35237.50	4.89	26746.99	4.79
1.6 + 3.2 + 5.0	60.8 (16)	66835.88	3.48	65569.89	3.56	59239.93	3.94	55441.96	4.18	51890.11	4.36	37682.71	5.09	38743.60	5.11	41395.81	5.17	42456.70	5.19	38398.81	4.96	31635.65	4.57
	64.4 (18)	63653.22	3.60	62203.34	3.68	54953.95	4.03	50604.31	4.25	47396.19	4.44	34563.70	5.23	36360.14	5.21	40851.22	5.16	42647.66	5.14	38613.64	4.93	31890.27	4.59
	68.0 (20)	61616.32	3.73	59925.97	3.79	51474.24	4.11	46403.20	4.30	43462.42	4.49	31699.31	5.23	34146.42	5.20	40264.20	5.13	42711.31	5.10	38486.33	4.96	31444.69	4.71
	69.8 (21)	60852.48	3.80	59034.83	3.85	49946.56	4.09	44493.60	4.23	41654.67	4.43	30298.93	5.25	32293.40	5.21	37279.57	5.13	39274.04	5.10	36147.07	4.97	30935.47	4.75
	71.6 (22)	60343.26	3.87	59098.48	3.92	52874.61	4.18	49140.29	4.34	45104.67	4.52	28962.22	5.26	32017.57	5.23	39655.96	5.14	42711.31	5.10	38008.93	5.00	30171.63	4.82
	75.2 (24)	59961.34	4.01	57726.40	4.05	46551.72	4.25	39846.92	4.37	37148.02	4.56	26352.43	5.33	29945.31	5.29	38927.48	5.18	42520.35	5.14	37149.61	5.07	28198.38	4.96
1.6 + 3.2 + 7.0	60.8 (16)	67818.77	3.51	66534.16	3.59	60111.11	3.98	56257.28	4.21	52653.20	4.40	38236.87	5.13	39313.35	5.16	42004.58	5.22	43081.06	5.24	38963.50	5.00	32100.88	4.61
	64.4 (18)	64589.30	3.64	63118.10	3.71	55762.10	4.07	51348.49	4.29	48093.19	4.48	35071.99	5.28	36894.84	5.26	41451.98	5.21	43274.83	5.19	39181.48	4.98	32359.24	4.63
	68.0 (20)	62522.44	3.76	60807.24	3.83	52231.21	4.15	47085.60	4.34	44101.57	4.53	32165.47	5.28	34648.57	5.25	40856.32	5.18	43339.42	5.15	39052.31	5.00	31907.11	4.75
	69.8 (21)	61747.37	3.84	59902.99	3.88	50681.07	4.12	45147.92	4.27	42267.24	4.47	30744.51	5.29	32768.31	5.26	37827.80	5.18	39851.60	5.15	36678.65	5.02	31390.40	4.79
	71.6 (22)	61230.66	3.91	59967.58	3.96	53652.18	4.22	49862.94	4.38	45767.98	4.56	29388.13	5.31	32488.42	5.28	40239.13	5.19	43339.42	5.15	38567.89	5.04	30615.33	4.86
	75.2 (24)	60843.12	4.05	58575.32	4.09	47236.31	4.29	40432.90	4.41	37694.32	4.61	26739.97	5.38	30385.68	5.34	39499.95	5.23	43145.65	5.19	37695.93	5.12	28613.06	5.01
1.6 + 5.0 + 5.0	60.8 (16)	67818.77	3.39	66534.16	3.47	60111.11	3.84	56257.28	4.07	52653.20	4.25	38236.87	4.95	39313.35	4.98	42004.58	5.04	43081.06	5.06	38963.50	4.83	32100.88	4.45
	64.4 (18)	64589.30	3.51	63118.10	3.58	55762.10	3.93	51348.49	4.14	48093.19	4.33	35071.99	5.09	36894.84	5.07	41451.98	5.03	43274.83	5.01	39181.48	4.81	32359.24	4.47
	68.0 (20)	62522.44	3.63	60807.24	3.70	52231.21	4.00	47085.60	4.19	44101.57	4.37	32165.47	5.09	34648.57	5.07	40856.32	5.00	43339.42	4.97	39052.31	4.83	31907.11	4.59
	69.8 (21)	61747.37	3.70	59902.99	3.75	50681.07	3.98	45147.92	4.12	42267.24	4.32	30744.51	5.11	32768.31	5.08	37827.80	5.00	39851.60	4.97	36678.65	4.84	31390.40	4.62
	71.6 (22)	61230.66	3.77	59967.58	3.82	53652.18	4.07	49862.94	4.22	45767.98	4.41	29388.13	5.13	32488.42	5.09	40239.13	5.01	43339.42	4.97	38567.89	4.87	30615.33	4.69
	75.2 (24)	60843.12	3.91	58575.32	3.95	47236.31	4.14	40432.90	4.26	37694.32	4.45	26739.97	5.20	30385.68	5.16	39499.95	5.05	43145.65	5.01	37695.93	4.94	28613.06	4.83

Combination (Capacity)	Indoor Air Temp. °F (°C) DB	Outdoor Air Temp. °F (°C) WB																					
		60.8 (16)		59.0 (15)		50.0 (10)		44.6 (7)		42.8 (6)		35.6 (2)		32.0 (0)		23.0 (-5)		19.4 (-7)		14.0 (-10)		5.0 (-15)	
		Total Capacity (BTU/h)	Input Power (kW)	Total Capacity (BTU/h)	Input Power (kW)	Total Capacity (BTU/h)	Input Power (kW)	Total Capacity (BTU/h)	Input Power (kW)	Total Capacity (BTU/h)	Input Power (kW)	Total Capacity (BTU/h)	Input Power (kW)	Total Capacity (BTU/h)	Input Power (kW)	Total Capacity (BTU/h)	Input Power (kW)	Total Capacity (BTU/h)	Input Power (kW)	Total Capacity (BTU/h)	Input Power (kW)	Total Capacity (BTU/h)	Input Power (kW)
1.6 + 5.0 + 7.0	60.8 (16)	69293.09	3.48	67980.55	3.56	61417.87	3.94	57480.27	4.18	53797.83	4.36	39068.10	5.09	40167.99	5.11	42917.72	5.17	44017.61	5.19	39810.53	4.96	32798.73	4.57
	64.4 (18)	65993.42	3.60	64490.23	3.68	56974.32	4.03	52464.77	4.25	49138.70	4.44	35834.42	5.23	37696.91	5.21	42353.11	5.16	44215.59	5.14	40033.26	4.93	33062.70	4.59
	68.0 (20)	63881.63	3.73	61219.13	3.79	53366.68	4.11	48109.20	4.30	45060.30	4.49	32864.72	5.23	35401.80	5.20	41744.50	5.13	44281.58	5.10	39901.27	4.96	32600.75	4.71
	69.8 (21)	63089.71	3.80	61205.23	3.85	51782.83	4.09	46129.40	4.23	43186.09	4.43	31412.87	5.25	33480.66	5.21	38650.14	5.13	40717.94	5.10	37476.01	4.97	32072.80	4.75
	71.6 (22)	62561.76	3.87	61271.22	3.92	54818.53	4.18	50946.92	4.34	46762.93	4.52	30027.00	5.26	33194.69	5.23	41113.90	5.14	44281.58	5.10	39406.32	5.00	31280.88	4.82
	75.2 (24)	62165.80	4.01	59848.70	4.05	48263.18	4.25	41311.88	4.37	38513.76	4.56	27321.27	5.33	31046.24	5.29	40358.64	5.18	44083.60	5.14	38515.41	5.07	29235.08	4.96
2.0 + 2.0 + 2.0	60.8 (16)	60447.16	3.16	59302.18	3.23	53577.29	3.58	50142.36	3.79	46930.02	3.95	34080.68	4.61	35040.16	4.63	37438.86	4.69	38398.34	4.71	34728.33	4.50	28611.66	4.14
	64.4 (18)	57568.72	3.27	56257.44	3.33	49701.00	3.66	45767.14	3.85	42865.67	4.03	31259.82	4.74	32884.53	4.72	36946.33	4.68	38571.05	4.66	34922.63	4.47	28841.93	4.16
	68.0 (20)	55726.53	3.38	54197.76	3.44	46553.91	3.73	41967.60	3.90	39307.92	4.07	28669.22	4.74	30882.42	4.72	36415.42	4.65	38628.61	4.63	34807.49	4.49	28438.95	4.27
	69.8 (21)	55035.70	3.45	53391.79	3.49	45172.26	3.71	40240.54	3.84	37672.97	4.02	27402.71	4.76	29206.53	4.73	33716.08	4.66	35519.90	4.63	32691.84	4.51	27978.40	4.30
	71.6 (22)	54575.15	3.51	53449.36	3.56	47820.42	3.79	44443.06	3.93	40793.20	4.10	26193.77	4.77	28957.07	4.74	35865.32	4.66	38628.61	4.63	34375.72	4.53	27287.58	4.37
	75.2 (24)	54229.74	3.64	52208.44	3.68	42101.93	3.86	36038.02	3.96	33597.11	4.14	23833.45	4.84	27082.89	4.80	35206.47	4.70	38455.91	4.66	33598.55	4.60	25502.94	4.50
2.0 + 2.0 + 2.5	60.8 (16)	60447.16	3.16	59302.18	3.23	53577.29	3.58	50142.36	3.79	46930.02	3.95	34080.68	4.61	35040.16	4.63	37438.86	4.69	38398.34	4.71	34728.33	4.50	28611.66	4.14
	64.4 (18)	57568.72	3.27	56257.44	3.33	49701.00	3.66	45767.14	3.85	42865.67	4.03	31259.82	4.74	32884.53	4.72	36946.33	4.68	38571.05	4.66	34922.63	4.47	28841.93	4.16
	68.0 (20)	55726.53	3.38	54197.76	3.44	46553.91	3.73	41967.60	3.90	39307.92	4.07	28669.22	4.74	30882.42	4.72	36415.42	4.65	38628.61	4.63	34807.49	4.49	28438.95	4.27
	69.8 (21)	55035.70	3.45	53391.79	3.49	45172.26	3.71	40240.54	3.84	37672.97	4.02	27402.71	4.76	29206.53	4.73	33716.08	4.66	35519.90	4.63	32691.84	4.51	27978.40	4.30
	71.6 (22)	54575.15	3.51	53449.36	3.56	47820.42	3.79	44443.06	3.93	40793.20	4.10	26193.77	4.77	28957.07	4.74	35865.32	4.66	38628.61	4.63	34375.72	4.53	27287.58	4.37
	75.2 (24)	54229.74	3.64	52208.44	3.68	42101.93	3.86	36038.02	3.96	33597.11	4.14	23833.45	4.84	27082.89	4.80	35206.47	4.70	38455.91	4.66	33598.55	4.60	25502.94	4.50
2.0 + 2.0 + 3.2	60.8 (16)	60447.16	3.13	59302.18	3.20	53577.29	3.55	50142.36	3.76	46930.02	3.92	34080.68	4.58	35040.16	4.60	37438.86	4.65	38398.34	4.67	34728.33	4.46	28611.66	4.11
	64.4 (18)	57568.72	3.24	56257.44	3.31	49701.00	3.63	45767.14	3.82	42865.67	4.00	31259.82	4.71	32884.53	4.69	36946.33	4.64	38571.05	4.62	34922.63	4.44	28841.93	4.13
	68.0 (20)	55726.53	3.36	54197.76	3.41	46553.91	3.70	41967.60	3.87	39307.92	4.04	28669.22	4.71	30882.42	4.68	36415.42	4.62	38628.61	4.59	34807.49	4.46	28438.95	4.24
	69.8 (21)	55035.70	3.42	53391.79	3.46	45172.26	3.68	40240.54	3.81	37672.97	3.99	27402.71	4.72	29206.53	4.69	33716.08	4.62	35519.90	4.59	32691.84	4.47	27978.40	4.27
	71.6 (22)	54575.15	3.48	53449.36	3.53	47820.42	3.76	44443.06	3.90	40793.20	4.07	26193.77	4.74	28957.07	4.71	35865.32	4.62	38628.61	4.59	34375.72	4.50	27287.58	4.34
	75.2 (24)	54229.74	3.61	52208.44	3.65	42101.93	3.83	36038.02	3.93	33597.11	4.11	23833.45	4.80	27082.89	4.76	35206.47	4.66	38455.91	4.62	33598.55	4.56	25502.94	4.46
2.0 + 2.0 + 5.0	60.8 (16)	66835.88	3.50	65569.89	3.57	59239.93	3.96	55441.96	4.19	51890.11	4.38	37682.71	5.11	38743.60	5.13	41395.81	5.19	42456.70	5.22	38398.81	4.98	31635.65	4.59
	64.4 (18)	63653.22	3.62	62203.34	3.69	54953.95	4.05	50604.31	4.27	47396.19	4.46	34563.70	5.25	36360.14	5.23	40851.22	5.18	42647.66	5.16	38613.64	4.95	31890.27	4.61
	68.0 (20)	61616.32	3.75	59925.97	3.81	51474.24	4.13	46403.20	4.32	43462.42	4.51	31699.31	5.25	34146.42	5.22	40264.20	5.15	42711.31	5.13	38486.33	4.98	31444.69	4.73
	69.8 (21)	60852.48	3.82	59034.83	3.87	49946.56	4.11	44493.60	4.25	41654.67	4.45	30298.93	5.27	32293.40	5.24	37279.57	5.16	39274.04	5.13	36147.07	4.99	30935.47	4.77
	71.6 (22)	60343.26	3.89	59098.48	3.94	52874.61	4.20	49140.29	4.36	45104.67	4.54	28962.22	5.29	32017.57	5.25	39655.96	5.16	42711.31	5.13	38008.93	5.02	30171.63	4.84
	75.2 (24)	59961.34	4.03	57726.40	4.07	46551.72	4.27	39846.92	4.39	37148.02	4.59	26352.43	5.36	29945.31	5.32	38927.48	5.21	42520.35	5.16	37149.61	5.10	28198.38	4.98
2.0 + 2.0 + 7.0	60.8 (16)	67818.77	3.54	66534.16	3.61	60111.11	4.01	56257.28	4.24	52653.20	4.43	38236.87	5.17	39313.35	5.19	42004.58	5.25	43081.06	5.28	38963.50	5.04	32100.88	4.64
	64.4 (18)	64589.30	3.66	63118.10	3.74	55762.10	4.10	51348.49	4.32	48093.19	4.52	35071.99	5.31	36894.84	5.29	41451.98	5.24	43274.83	5.22	39181.48	5.01	32359.24	4.66
	68.0 (20)	62522.44	3.79	60807.24	3.85	52231.21	4.18	47085.60	4.37	44101.57	4.56	32165.47	5.31	34648.57	5.28	40856.32	5.21	43339.42	5.19	39052.31	5.04	31907.11	4.79
	69.8 (21)	61747.37	3.86	59902.99	3.91	50681.07	4.15	45147.92	4.30	42267.24	4.51	30744.51	5.33	32768.31	5.30	37827.80	5.22	39851.60	5.19	36678.65	5.05	31390.40	4.82
	71.6 (22)	61230.66	3.93	59967.58	3.99	53652.18	4.25	49862.94	4.41	45767.98	4.59	29388.13	5.35	32488.42	5.31	40239.13	5.22	43339.42	5.19	38567.89	5.08	30615.33	4.90
	75.2 (24)	60843.12	4.08	58575.32	4.12	47236.31	4.32	40432.90	4.44	37694.32	4.64	26739.97	5.42	30385.68	5.38	39499.95	5.27	43145.65	5.22	37695.93	5.15	28613.06	5.04

Combination (Capacity)	Indoor Air Temp. °F (°C) DB	Outdoor Air Temp. °F (°C) WB																					
		60.8 (16)		59.0 (15)		50.0 (10)		44.6 (7)		42.8 (6)		35.6 (2)		32.0 (0)		23.0 (-5)		19.4 (-7)		14.0 (-10)		5.0 (-15)	
		Total Capacity (BTU/h)	Input Power (kW)	Total Capacity (BTU/h)	Input Power (kW)	Total Capacity (BTU/h)	Input Power (kW)	Total Capacity (BTU/h)	Input Power (kW)	Total Capacity (BTU/h)	Input Power (kW)	Total Capacity (BTU/h)	Input Power (kW)	Total Capacity (BTU/h)	Input Power (kW)	Total Capacity (BTU/h)	Input Power (kW)	Total Capacity (BTU/h)	Input Power (kW)	Total Capacity (BTU/h)	Input Power (kW)	Total Capacity (BTU/h)	Input Power (kW)
2.0 + 2.5 + 2.5	60.8 (16)	60447.16	3.16	59302.18	3.23	53577.29	3.58	50142.36	3.79	46930.02	3.95	34080.68	4.61	35040.16	4.63	37438.86	4.69	38398.34	4.71	34728.33	4.50	28611.66	4.14
	64.4 (18)	57568.72	3.27	56257.44	3.33	49701.00	3.66	45767.14	3.85	42865.67	4.03	31259.82	4.74	32884.53	4.72	36946.33	4.68	38571.05	4.66	34922.63	4.47	28841.93	4.16
	68.0 (20)	55726.53	3.38	54197.76	3.44	46553.91	3.73	41967.60	3.90	39307.92	4.07	28669.22	4.74	30882.42	4.72	36415.42	4.65	38628.61	4.63	34807.49	4.49	28438.95	4.27
	69.8 (21)	55035.70	3.45	53391.79	3.49	45172.26	3.71	40240.54	3.84	37672.97	4.02	27402.71	4.76	29206.53	4.73	33716.08	4.66	35519.90	4.63	32691.84	4.51	27978.40	4.30
	71.6 (22)	54575.15	3.51	53449.36	3.56	47820.42	3.79	44443.06	3.93	40793.20	4.10	26193.77	4.77	28957.07	4.74	35865.32	4.66	38628.61	4.63	34375.72	4.53	27287.58	4.37
	75.2 (24)	54229.74	3.64	52208.44	3.68	42101.93	3.86	36038.02	3.96	33597.11	4.14	23833.45	4.84	27082.89	4.80	35206.47	4.70	38455.91	4.66	33598.55	4.60	25502.94	4.50
2.0 + 2.5 + 3.2	60.8 (16)	63395.80	3.37	62194.97	3.45	56190.82	3.82	52588.33	4.05	49219.29	4.23	35743.16	4.93	36749.44	4.95	39265.15	5.01	40271.43	5.04	36422.40	4.81	30007.35	4.43
	64.4 (18)	60376.95	3.50	59001.70	3.56	52125.44	3.91	47999.68	4.12	44956.68	4.31	32784.69	5.07	34488.66	5.05	38748.59	5.00	40452.56	4.98	36626.17	4.78	30248.85	4.45
	68.0 (20)	58444.89	3.62	56841.55	3.68	48824.83	3.99	44014.80	4.17	41225.38	4.35	30067.72	5.07	32388.88	5.04	38191.78	4.98	40512.94	4.95	36505.42	4.81	29826.22	4.57
	69.8 (21)	57720.37	3.69	55996.27	3.73	47375.78	3.96	42203.49	4.10	39510.68	4.30	28739.43	5.09	30631.24	5.06	35360.77	4.98	37252.58	4.95	34286.56	4.82	29343.20	4.60
	71.6 (22)	57237.35	3.75	56056.65	3.80	50153.12	4.05	46611.01	4.20	42783.11	4.38	27471.51	5.10	30369.61	5.07	37614.84	4.98	40512.94	4.95	36052.59	4.84	28618.68	4.67
	75.2 (24)	56875.09	3.89	54755.19	3.93	44155.68	4.12	37795.97	4.24	35235.99	4.43	24996.06	5.17	28404.00	5.13	36923.86	5.03	40331.81	4.98	35237.50	4.92	26746.99	4.81
2.0 + 2.5 + 5.0	60.8 (16)	66835.88	3.50	65569.89	3.57	59239.93	3.96	55441.96	4.19	51890.11	4.38	37682.71	5.11	38743.60	5.13	41395.81	5.19	42456.70	5.22	38398.81	4.98	31635.65	4.59
	64.4 (18)	63653.22	3.62	62203.34	3.69	54953.95	4.05	50604.31	4.27	47396.19	4.46	34563.70	5.25	36360.14	5.23	40851.22	5.18	42647.66	5.16	38613.64	4.95	31890.27	4.61
	68.0 (20)	61616.32	3.75	59925.97	3.81	51474.24	4.13	46403.20	4.32	43462.42	4.51	31699.31	5.25	34146.42	5.22	40264.20	5.15	42711.31	5.13	38486.33	4.98	31444.69	4.73
	69.8 (21)	60852.48	3.82	59034.83	3.87	49946.56	4.11	44493.60	4.25	41654.67	4.45	30298.93	5.27	32293.40	5.24	37279.57	5.16	39274.04	5.13	36147.07	4.99	30935.47	4.77
	71.6 (22)	60343.26	3.89	59098.48	3.94	52874.61	4.20	49140.29	4.36	45104.67	4.54	28962.22	5.29	32017.57	5.25	39655.96	5.16	42711.31	5.13	38008.93	5.02	30171.63	4.84
	75.2 (24)	59961.34	4.03	57726.40	4.07	46551.72	4.27	39846.92	4.39	37148.02	4.59	26352.43	5.36	29945.31	5.32	38927.48	5.21	42520.35	5.16	37149.61	5.10	28198.38	4.98
2.0 + 2.5 + 7.0	60.8 (16)	67818.77	3.54	66534.16	3.61	60111.11	4.01	56257.28	4.24	52653.20	4.43	38236.87	5.17	39313.35	5.19	42004.58	5.25	43081.06	5.28	38963.50	5.04	32100.88	4.64
	64.4 (18)	64589.30	3.66	63118.10	3.74	55762.10	4.10	51348.49	4.32	48093.19	4.52	35071.99	5.31	36894.84	5.29	41451.98	5.24	43274.83	5.22	39181.48	5.01	32359.24	4.66
	68.0 (20)	62522.44	3.79	60807.24	3.85	52231.21	4.18	47085.60	4.37	44101.57	4.56	32165.47	5.31	34648.57	5.28	40856.32	5.21	43339.42	5.19	39052.31	5.04	31907.11	4.79
	69.8 (21)	61747.37	3.86	59902.99	3.91	50681.07	4.15	45147.92	4.30	42267.24	4.51	30744.51	5.33	32768.31	5.30	37827.80	5.22	39851.60	5.19	36678.65	5.05	31390.40	4.82
	71.6 (22)	61230.66	3.93	59967.58	3.99	53652.18	4.25	49862.94	4.41	45767.98	4.59	29388.13	5.35	32488.42	5.31	40239.13	5.22	43339.42	5.19	38567.89	5.08	30615.33	4.90
	75.2 (24)	60843.12	4.08	58575.32	4.12	47236.31	4.32	40432.90	4.44	37694.32	4.64	26739.97	5.42	30385.68	5.38	39499.95	5.27	43145.65	5.22	37695.93	5.15	28613.06	5.04
2.0 + 3.2 + 3.2	60.8 (16)	63395.80	3.35	62194.97	3.42	56190.82	3.80	52588.33	4.02	49219.29	4.19	35743.16	4.90	36749.44	4.92	39265.15	4.98	40271.43	5.00	36422.40	4.77	30007.35	4.40
	64.4 (18)	60376.95	3.47	59001.70	3.54	52125.44	3.88	47999.68	4.09	44956.68	4.28	32784.69	5.03	34488.66	5.01	38748.59	4.97	40452.56	4.95	36626.17	4.75	30248.85	4.41
	68.0 (20)	58444.89	3.59	56841.55	3.65	48824.83	3.96	44014.80	4.14	41225.38	4.32	30067.72	5.03	32388.88	5.01	38191.78	4.94	40512.94	4.91	36505.42	4.77	29826.22	4.54
	69.8 (21)	57720.37	3.66	55996.27	3.70	47375.78	3.93	42203.49	4.07	39510.68	4.27	28739.43	5.05	30631.24	5.02	35360.77	4.94	37252.58	4.91	34286.56	4.78	29343.20	4.57
	71.6 (22)	57237.35	3.73	56056.65	3.78	50153.12	4.03	46611.01	4.17	42783.11	4.35	27471.51	5.07	30369.61	5.03	37614.84	4.95	40512.94	4.91	36052.59	4.81	28618.68	4.64
	75.2 (24)	56875.09	3.87	54755.19	3.90	44155.68	4.09	37795.97	4.21	35235.99	4.39	24996.06	5.14	28404.00	5.09	36923.86	4.99	40331.81	4.95	35237.50	4.88	26746.99	4.78
2.0 + 3.2 + 5.0	60.8 (16)	66835.88	3.41	65569.89	3.49	59239.93	3.87	55441.96	4.10	51890.11	4.28	37682.71	4.99	38743.60	5.01	41395.81	5.07	42456.70	5.10	38398.81	4.87	31635.65	4.48
	64.4 (18)	63653.22	3.54	62203.34	3.61	54953.95	3.96	50604.31	4.17	47396.19	4.36	34563.70	5.13	36360.14	5.11	40851.22	5.06	42647.66	5.04	38613.64	4.84	31890.27	4.50
	68.0 (20)	61616.32	3.66	59925.97	3.72	51474.24	4.03	46403.20	4.22	43462.42	4.40	31699.31	5.13	34146.42	5.10	40264.20	5.04	42711.31	5.01	38486.33	4.86	31444.69	4.62
	69.8 (21)	60852.48	3.73	59034.83	3.78	49946.56	4.01	44493.60	4.15	41654.67	4.35	30298.93	5.15	32293.40	5.12	37279.57	5.04	39274.04	5.01	36147.07	4.88	30935.47	4.66
	71.6 (22)	60343.26	3.80	59098.48	3.85	52874.61	4.10	49140.29	4.26	45104.67	4.44	28962.22	5.17	32017.57	5.13	39655.96	5.04	42711.31	5.01	38008.93	4.90	30171.63	4.73
	75.2 (24)	59961.34	3.94	57726.40	3.98	46551.72	4.17	39846.92	4.29	37148.02	4.48	26352.43	5.24	29945.31	5.19	38927.48	5.09	42520.35	5.04	37149.61	4.98	28198.38	4.87

Combination (Capacity)	Indoor Air Temp. °F (°C) DB	Outdoor Air Temp. °F (°C) WB																							
		60.8 (16)		59.0 (15)		50.0 (10)		44.6 (7)		42.8 (6)		35.6 (2)		32.0 (0)		23.0 (-5)		19.4 (-7)		14.0 (-10)		5.0 (-15)			
		Total Capacity (BTU/h)	Input Power (kW)	Total Capacity (BTU/h)	Input Power (kW)	Total Capacity (BTU/h)	Input Power (kW)	Total Capacity (BTU/h)	Input Power (kW)	Total Capacity (BTU/h)	Input Power (kW)	Total Capacity (BTU/h)	Input Power (kW)	Total Capacity (BTU/h)	Input Power (kW)	Total Capacity (BTU/h)	Input Power (kW)	Total Capacity (BTU/h)	Input Power (kW)	Total Capacity (BTU/h)	Input Power (kW)	Total Capacity (BTU/h)	Input Power (kW)		
2.0 + 3.2 + 7.0	60.8 (16)	67818.77	3.50	66534.16	3.58	60111.11	3.97	56257.28	4.20	52653.20	4.39	38236.87	5.12	39313.35	5.14	42004.58	5.20	43081.06	5.23	38963.50	4.99	32100.88	4.60		
	64.4 (18)	64589.30	3.63	63118.10	3.70	55762.10	4.06	51348.49	4.28	48093.19	4.47	35071.99	5.26	36894.84	5.24	41451.98	5.19	43274.83	5.17	39181.48	4.97	32359.24	4.62		
	68.0 (20)	62522.44	3.76	60807.24	3.82	52231.21	4.14	47085.60	4.33	44101.57	4.52	32165.47	5.26	34648.57	5.24	40856.32	5.17	43339.42	5.14	39052.31	4.99	31907.11	4.74		
	69.8 (21)	61747.37	3.83	59902.99	3.87	50681.07	4.12	45147.92	4.26	42267.24	4.46	30744.51	5.28	32768.31	5.25	37827.80	5.17	39851.60	5.14	36678.65	5.00	31390.40	4.78		
	71.6 (22)	61230.66	3.90	59967.58	3.95	53652.18	4.21	49862.94	4.37	45767.98	4.55	29388.13	5.30	32488.42	5.26	40239.13	5.17	43339.42	5.14	38567.89	5.03	30615.33	4.85		
	75.2 (24)	60843.12	4.04	58575.32	4.08	47236.31	4.28	40432.90	4.40	37694.32	4.60	26739.97	5.37	30385.68	5.33	39499.95	5.22	43145.65	5.17	37695.93	5.11	28613.06	4.99		
2.0 + 5.0 + 5.0	60.8 (16)	67818.77	3.33	66534.16	3.40	60111.11	3.77	56257.28	3.99	52653.20	4.16	38236.87	4.86	39313.35	4.88	42004.58	4.94	43081.06	4.96	38963.50	4.74	32100.88	4.37		
	64.4 (18)	64589.30	3.44	63118.10	3.51	55762.10	3.85	51348.49	4.06	48093.19	4.25	35071.99	5.00	36894.84	4.98	41451.98	4.93	43274.83	4.91	39181.48	4.71	32359.24	4.38		
	68.0 (20)	62522.44	3.56	60807.24	3.62	52231.21	3.93	47085.60	4.11	44101.57	4.29	32165.47	5.00	34648.57	4.97	40856.32	4.90	43339.42	4.88	39052.31	4.74	31907.11	4.50		
	69.8 (21)	61747.37	3.63	59902.99	3.68	50681.07	3.91	45147.92	4.04	42267.24	4.24	30744.51	5.01	32768.31	4.98	37827.80	4.91	39851.60	4.88	36678.65	4.75	31390.40	4.54		
	71.6 (22)	61230.66	3.70	59967.58	3.75	53652.18	4.00	49862.94	4.14	45767.98	4.32	29388.13	5.03	32488.42	5.00	40239.13	4.91	43339.42	4.88	38567.89	4.78	30615.33	4.60		
	75.2 (24)	60843.12	3.84	58575.32	3.88	47236.31	4.06	40432.90	4.18	37694.32	4.36	26739.97	5.10	30385.68	5.06	39499.95	4.95	43145.65	4.91	37695.93	4.85	28613.06	4.74		
2.5 + 2.5 + 2.5	60.8 (16)	60447.16	3.16	59302.18	3.23	53577.29	3.58	50142.36	3.79	46930.02	3.95	34080.68	4.61	35040.16	4.63	37438.86	4.69	38398.34	4.71	34728.33	4.50	28611.66	4.14		
	64.4 (18)	57568.72	3.27	56257.44	3.33	49701.00	3.66	45767.14	3.85	42865.67	4.03	31259.82	4.74	32884.53	4.72	36946.33	4.68	38571.05	4.66	34922.63	4.47	28841.93	4.16		
	68.0 (20)	55726.53	3.38	54197.76	3.44	46553.91	3.73	41967.60	3.90	39307.92	4.07	28669.22	4.74	30882.42	4.72	36415.42	4.65	38628.61	4.63	34807.49	4.49	28438.95	4.27		
	69.8 (21)	55035.70	3.45	53391.79	3.49	45172.26	3.71	40240.54	3.84	37672.97	4.02	27402.71	4.76	29206.53	4.73	33716.08	4.66	35519.90	4.63	32691.84	4.51	27978.40	4.30		
	71.6 (22)	54575.15	3.51	53449.36	3.56	47820.42	3.79	44443.06	3.93	40793.20	4.10	26193.77	4.77	28957.07	4.74	35865.32	4.66	38628.61	4.63	34375.72	4.53	27287.58	4.37		
	75.2 (24)	54229.74	3.64	52208.44	3.68	42101.93	3.86	36038.02	3.96	33597.11	4.14	23833.45	4.84	27082.89	4.80	35206.47	4.70	38455.91	4.66	33598.55	4.60	25502.94	4.50		
2.5 + 2.5 + 3.2	60.8 (16)	63395.80	3.37	62194.97	3.45	56190.82	3.82	52588.33	4.05	49219.29	4.23	35743.16	4.93	36749.44	4.95	39265.15	5.01	40271.43	5.04	36422.40	4.81	30007.35	4.43		
	64.4 (18)	60376.95	3.50	59001.70	3.56	52125.44	3.91	47999.68	4.12	44956.68	4.31	32784.69	5.07	34488.66	5.05	38748.59	5.00	40452.56	4.98	36626.17	4.78	30248.85	4.45		
	68.0 (20)	58444.89	3.62	56841.55	3.68	48824.83	3.99	44014.80	4.17	41225.38	4.35	30067.72	5.07	32388.88	5.04	38191.78	4.98	40512.94	4.95	36505.42	4.81	29826.22	4.57		
	69.8 (21)	57720.37	3.69	55996.27	3.73	47375.78	3.96	42203.49	4.10	39510.68	4.30	28739.43	5.09	30631.24	5.06	35360.77	4.98	37252.58	4.95	34286.56	4.82	29343.20	4.60		
	71.6 (22)	57237.35	3.75	56056.65	3.80	50153.12	4.05	46611.01	4.20	42783.11	4.38	27471.51	5.10	30369.61	5.07	37614.84	4.98	40512.94	4.95	36052.59	4.84	28618.68	4.67		
	75.2 (24)	56875.09	3.89	54755.19	3.93	44155.68	4.12	37795.97	4.24	35235.99	4.43	24996.06	5.17	28404.00	5.13	36923.86	5.03	40331.81	4.98	35237.50	4.92	26746.99	4.81		
2.5 + 2.5 + 5.0	60.8 (16)	66835.88	3.50	65569.89	3.57	59239.93	3.96	55441.96	4.19	51890.11	4.38	37682.71	5.11	38743.60	5.13	41395.81	5.19	42456.70	5.22	38398.81	4.98	31635.65	4.59		
	64.4 (18)	63653.22	3.62	62203.34	3.69	54953.95	4.05	50604.31	4.27	47396.19	4.46	34563.70	5.25	36360.14	5.23	40851.22	5.18	42647.66	5.16	38613.64	4.95	31890.27	4.61		
	68.0 (20)	61616.32	3.75	59925.97	3.81	51474.24	4.13	46403.20	4.32	43462.42	4.51	31699.31	5.25	34146.42	5.22	40264.20	5.15	42711.31	5.13	38486.33	4.98	31444.69	4.73		
	69.8 (21)	60852.48	3.82	59034.83	3.87	49946.56	4.11	44493.60	4.25	41654.67	4.45	30298.93	5.27	32293.40	5.24	37279.57	5.16	39274.04	5.13	36147.07	4.99	30935.47	4.77		
	71.6 (22)	60343.26	3.89	59098.48	3.94	52874.61	4.20	49140.29	4.36	45104.67	4.54	28962.22	5.29	32017.57	5.25	39655.96	5.16	42711.31	5.13	38008.93	5.02	30171.63	4.84		
	75.2 (24)	59961.34	4.03	57726.40	4.07	46551.72	4.27	39846.92	4.39	37148.02	4.59	26352.43	5.36	29945.31	5.32	38927.48	5.21	42520.35	5.16	37149.61	5.10	28198.38	4.98		
2.5 + 2.5 + 7.0	60.8 (16)	67818.77	3.54	66534.16	3.61	60111.11	4.01	56257.28	4.24	52653.20	4.43	38236.87	5.17	39313.35	5.19	42004.58	5.25	43081.06	5.28	38963.50	5.04	32100.88	4.64		
	64.4 (18)	64589.30	3.66	63118.10	3.74	55762.10	4.10	51348.49	4.32	48093.19	4.52	35071.99	5.31	36894.84	5.29	41451.98	5.24	43274.83	5.22	39181.48	5.01	32359.24	4.66		
	68.0 (20)	62522.44	3.79	60807.24	3.85	52231.21	4.18	47085.60	4.37	44101.57	4.56	32165.47	5.31	34648.57	5.28	40856.32	5.21	43339.42	5.19	39052.31	5.04	31907.11	4.79		
	69.8 (21)	61747.37	3.86	59902.99	3.91	50681.07	4.15	45147.92	4.30	42267.24	4.51	30744.51	5.33	32768.31	5.30	37827.80	5.22	39851.60	5.19	36678.65	5.05	31390.40	4.82		
	71.6 (22)	61230.66	3.93	59967.58	3.99	53652.18	4.25	49862.94	4.41	45767.98	4.59	29388.13	5.35	32488.42	5.31	40239.13	5.22	43339.42	5.19	38567.89	5.08	30615.33	4.90		
	75.2 (24)	60843.12	4.08	58575.32	4.12	47236.31	4.32	40432.90	4.44	37694.32	4.64	26739.97	5.42	30385.68	5.38	39499.95	5.27	43145.65	5.22	37695.93	5.15	28613.06	5.04		

Combination (Capacity)	Indoor Air Temp. °F (°C) DB	Outdoor Air Temp. °F (°C) WB																					
		60.8 (16)		59.0 (15)		50.0 (10)		44.6 (7)		42.8 (6)		35.6 (2)		32.0 (0)		23.0 (-5)		19.4 (-7)		14.0 (-10)		5.0 (-15)	
		Total Capacity (BTU/h)	Input Power (kW)	Total Capacity (BTU/h)	Input Power (kW)	Total Capacity (BTU/h)	Input Power (kW)	Total Capacity (BTU/h)	Input Power (kW)	Total Capacity (BTU/h)	Input Power (kW)	Total Capacity (BTU/h)	Input Power (kW)	Total Capacity (BTU/h)	Input Power (kW)	Total Capacity (BTU/h)	Input Power (kW)	Total Capacity (BTU/h)	Input Power (kW)	Total Capacity (BTU/h)	Input Power (kW)	Total Capacity (BTU/h)	Input Power (kW)
2.5 + 3.2 + 3.2	60.8 (16)	66835.88	3.65	65569.89	3.73	59239.93	4.14	55441.96	4.38	51890.11	4.57	37682.71	5.33	38743.60	5.36	41395.81	5.42	42456.70	5.45	38398.81	5.20	31635.65	4.79
	64.4 (18)	63653.22	3.78	62203.34	3.86	54953.95	4.23	50604.31	4.45	47396.19	4.66	34563.70	5.48	36360.14	5.46	40851.22	5.41	42647.66	5.39	38613.64	5.17	31890.27	4.81
	68.0 (20)	61616.32	3.91	59925.97	3.98	51474.24	4.31	46403.20	4.51	43462.42	4.70	31699.31	5.48	34146.42	5.45	40264.20	5.38	42711.31	5.35	38486.33	5.20	31444.69	4.94
	69.8 (21)	60852.48	3.99	59034.83	4.04	49946.56	4.29	44493.60	4.44	41654.67	4.65	30298.93	5.50	32293.40	5.47	37279.57	5.39	39274.04	5.35	36147.07	5.21	30935.47	4.98
	71.6 (22)	60343.26	4.06	59098.48	4.11	52874.61	4.39	49140.29	4.55	45104.67	4.74	28962.22	5.52	32017.57	5.48	39655.96	5.39	42711.31	5.35	38008.93	5.24	30171.63	5.05
	75.2 (24)	59961.34	4.21	57726.40	4.25	46551.72	4.46	39846.92	4.58	37148.02	4.79	26352.43	5.60	29945.31	5.55	38927.48	5.44	42520.35	5.39	37149.61	5.32	28198.38	5.20
2.5 + 3.2 + 5.0	60.8 (16)	67818.77	3.52	66534.16	3.60	60111.11	3.99	56257.28	4.22	52653.20	4.41	38236.87	5.14	39313.35	5.17	42004.58	5.23	43081.06	5.25	38963.50	5.02	32100.88	4.62
	64.4 (18)	64589.30	3.65	63118.10	3.72	55762.10	4.08	51348.49	4.30	48093.19	4.49	35071.99	5.29	36894.84	5.27	41451.98	5.22	43274.83	5.20	39181.48	4.99	32359.24	4.64
	68.0 (20)	62522.44	3.77	60807.24	3.84	52231.21	4.16	47085.60	4.35	44101.57	4.54	32165.47	5.29	34648.57	5.26	40856.32	5.19	43339.42	5.16	39052.31	5.01	31907.11	4.77
	69.8 (21)	61747.37	3.84	59902.99	3.89	50681.07	4.13	45147.92	4.28	42267.24	4.48	30744.51	5.31	32768.31	5.27	37827.80	5.19	39851.60	5.16	36678.65	5.03	31390.40	4.80
	71.6 (22)	61230.66	3.92	59967.58	3.97	53652.18	4.23	49862.94	4.39	45767.98	4.57	29388.13	5.32	32488.42	5.29	40239.13	5.20	43339.42	5.16	38567.89	5.05	30615.33	4.87
	75.2 (24)	60843.12	4.06	58575.32	4.10	47236.31	4.30	40432.90	4.42	37694.32	4.62	26739.97	5.40	30385.68	5.35	39499.95	5.24	43145.65	5.20	37695.93	5.13	28613.06	5.02
2.5 + 3.2 + 7.0	60.8 (16)	69293.09	3.66	67980.55	3.74	61417.87	4.14	57480.27	4.39	53797.83	4.58	39068.10	5.35	40167.99	5.37	42917.72	5.43	44017.61	5.46	39810.53	5.21	32798.73	4.80
	64.4 (18)	65993.42	3.79	64490.23	3.86	56974.32	4.24	52464.77	4.46	49138.70	4.67	35834.42	5.50	37696.91	5.47	42353.11	5.42	44215.59	5.40	40033.26	5.18	33062.70	4.82
	68.0 (20)	63881.63	3.92	62129.13	3.99	53366.68	4.32	48109.20	4.52	45060.30	4.72	32864.72	5.50	35401.80	5.47	41744.50	5.39	44281.58	5.36	39901.27	5.21	32600.75	4.95
	69.8 (21)	63089.71	3.99	61205.23	4.05	51782.83	4.30	46129.40	4.45	43186.09	4.66	31412.87	5.51	33480.66	5.48	38650.14	5.40	40717.94	5.36	37476.01	5.22	32072.80	4.99
	71.6 (22)	62561.76	4.07	61271.22	4.12	54818.53	4.39	50946.92	4.56	46762.93	4.75	30027.00	5.53	33194.69	5.50	41113.90	5.40	44281.58	5.36	39406.32	5.25	31280.88	5.06
	75.2 (24)	62165.80	4.22	59848.70	4.26	48263.18	4.47	41311.88	4.60	38513.76	4.80	27321.27	5.61	31046.24	5.56	40358.64	5.45	44083.60	5.40	38515.41	5.33	29235.08	5.21
2.5 + 5.0 + 5.0	60.8 (16)	67818.77	3.33	66534.16	3.40	60111.11	3.77	56257.28	3.99	52653.20	4.16	38236.87	4.86	39313.35	4.88	42004.58	4.94	43081.06	4.96	38963.50	4.74	32100.88	4.37
	64.4 (18)	64589.30	3.44	63118.10	3.51	55762.10	3.85	51348.49	4.06	48093.19	4.25	35071.99	5.00	36894.84	4.98	41451.98	4.93	43274.83	4.91	39181.48	4.71	32359.24	4.38
	68.0 (20)	62522.44	3.56	60807.24	3.62	52231.21	3.93	47085.60	4.11	44101.57	4.29	32165.47	5.00	34648.57	4.97	40856.32	4.90	43339.42	4.88	39052.31	4.74	31907.11	4.50
	69.8 (21)	61747.37	3.63	59902.99	3.68	50681.07	3.91	45147.92	4.04	42267.24	4.24	30744.51	5.01	32768.31	4.98	37827.80	4.91	39851.60	4.88	36678.65	4.75	31390.40	4.54
	71.6 (22)	61230.66	3.70	59967.58	3.75	53652.18	4.00	49862.94	4.14	45767.98	4.32	29388.13	5.03	32488.42	5.00	40239.13	4.91	43339.42	4.88	38567.89	4.78	30615.33	4.60
	75.2 (24)	60843.12	3.84	58575.32	3.88	47236.31	4.06	40432.90	4.18	37694.32	4.36	26739.97	5.10	30385.68	5.06	39499.95	4.95	43145.65	4.91	37695.93	4.85	28613.06	4.74
3.2 + 3.2 + 3.2	60.8 (16)	66835.88	3.62	65569.89	3.71	59239.93	4.11	55441.96	4.35	51890.11	4.54	37682.71	5.30	38743.60	5.32	41395.81	5.38	42456.70	5.41	38398.81	5.17	31635.65	4.76
	64.4 (18)	63653.22	3.76	62203.34	3.83	54953.95	4.20	50604.31	4.42	47396.19	4.63	34563.70	5.45	36360.14	5.43	40851.22	5.37	42647.66	5.35	38613.64	5.14	31890.27	4.78
	68.0 (20)	61616.32	3.89	59925.97	3.95	51474.24	4.28	46403.20	4.48	43462.42	4.67	31699.31	5.45	34146.42	5.42	40264.20	5.35	42711.31	5.32	38486.33	5.16	31444.69	4.91
	69.8 (21)	60852.48	3.96	59034.83	4.01	49946.56	4.26	44493.60	4.41	41654.67	4.62	30298.93	5.47	32293.40	5.43	37279.57	5.35	39274.04	5.32	36147.07	5.18	30935.47	4.94
	71.6 (22)	60343.26	4.03	59098.48	4.09	52874.61	4.36	49140.29	4.52	45104.67	4.71	28962.22	5.48	32017.57	5.45	39655.96	5.35	42711.31	5.32	38008.93	5.20	30171.63	5.02
	75.2 (24)	59961.34	4.18	57726.40	4.22	46551.72	4.43	39846.92	4.55	37148.02	4.76	26352.43	5.56	29945.31	5.51	38927.48	5.40	42520.35	5.35	37149.61	5.28	28198.38	5.17
3.2 + 3.2 + 5.0	60.8 (16)	67818.77	3.49	66534.16	3.56	60111.11	3.95	56257.28	4.18	52653.20	4.37	38236.87	5.10	39313.35	5.12	42004.58	5.18	43081.06	5.20	38963.50	4.97	32100.88	4.58
	64.4 (18)	64589.30	3.61	63118.10	3.68	55762.10	4.04	51348.49	4.26	48093.19	4.45	35071.99	5.24	36894.84	5.22	41451.98	5.17	43274.83	5.15	39181.48	4.94	32359.24	4.60
	68.0 (20)	62522.44	3.74	60807.24	3.80	52231.21	4.12	47085.60	4.31	44101.57	4.50	32165.47	5.24	34648.57	5.21	40856.32	5.14	43339.42	5.11	39052.31	4.97	31907.11	4.72
	69.8 (21)	61747.37	3.81	59902.99	3.86	50681.07	4.10	45147.92	4.24	42267.24	4.44	30744.51	5.26	32768.31	5.23	37827.80	5.15	39851.60	5.11	36678.65	4.98	31390.40	4.76
	71.6 (22)	61230.66	3.88	59967.58	3.93	53652.18	4.19	49862.94	4.35	45767.98	4.53	29388.13	5.28	32488.42	5.24	40239.13	5.15	43339.42	5.11	38567.89	5.01	30615.33	4.83
	75.2 (24)	60843.12	4.02	58575.32	4.06	47236.31	4.26	40432.90	4.38	37694.32	4.57	26739.97	5.35	30385.68	5.30	39499.95	5.19	43145.65	5.15	37695.93	5.08	28613.06	4.97

Combination (Capacity)	Indoor Air Temp. °F (°C) DB	Outdoor Air Temp. °F (°C) WB																					
		60.8 (16)		59.0 (15)		50.0 (10)		44.6 (7)		42.8 (6)		35.6 (2)		32.0 (0)		23.0 (-5)		19.4 (-7)		14.0 (-10)		5.0 (-15)	
		Total Capacity (BTU/h)	Input Power (kW)	Total Capacity (BTU/h)	Input Power (kW)	Total Capacity (BTU/h)	Input Power (kW)	Total Capacity (BTU/h)	Input Power (kW)	Total Capacity (BTU/h)	Input Power (kW)	Total Capacity (BTU/h)	Input Power (kW)	Total Capacity (BTU/h)	Input Power (kW)	Total Capacity (BTU/h)	Input Power (kW)	Total Capacity (BTU/h)	Input Power (kW)	Total Capacity (BTU/h)	Input Power (kW)	Total Capacity (BTU/h)	Input Power (kW)
3.2 + 3.2 + 7.0	60.8 (16)	69293.09	3.45	67980.55	3.52	61417.87	3.91	57480.27	4.14	53797.83	4.32	39068.10	5.04	40167.99	5.06	42917.72	5.12	44017.61	5.14	39810.53	4.91	32798.73	4.53
	64.4 (18)	65993.42	3.57	64490.23	3.64	56974.32	3.99	52464.77	4.21	49138.70	4.40	35834.42	5.18	37696.91	5.16	42353.11	5.11	44215.59	5.09	40033.26	4.89	33062.70	4.54
	68.0 (20)	63881.63	3.69	61219.13	3.76	53366.68	4.07	48109.20	4.26	45060.30	4.44	32864.72	5.18	35401.80	5.15	41744.50	5.08	44281.58	5.06	39901.27	4.91	32600.75	4.67
	69.8 (21)	63089.71	3.77	61205.23	3.81	51782.83	4.05	46129.40	4.19	43186.09	4.39	31412.87	5.20	33480.66	5.17	38650.14	5.09	40717.94	5.06	37476.01	4.92	32072.80	4.70
	71.6 (22)	62561.76	3.84	61271.22	3.89	54818.53	4.14	50946.92	4.30	46762.93	4.48	30027.00	5.21	33194.69	5.18	41113.90	5.09	44281.58	5.06	39406.32	4.95	31280.88	4.77
	75.2 (24)	62165.80	3.98	59848.70	4.02	48263.18	4.21	41311.88	4.33	38513.76	4.52	27321.27	5.29	31046.24	5.24	40358.64	5.13	44083.60	5.09	38515.41	5.02	29235.08	4.91
3.2 + 5.0 + 5.0	60.8 (16)	69293.09	3.45	67980.55	3.52	61417.87	3.91	57480.27	4.14	53797.83	4.32	39068.10	5.04	40167.99	5.06	42917.72	5.12	44017.61	5.14	39810.53	4.91	32798.73	4.53
	64.4 (18)	65993.42	3.57	64490.23	3.64	56974.32	3.99	52464.77	4.21	49138.70	4.40	35834.42	5.18	37696.91	5.16	42353.11	5.11	44215.59	5.09	40033.26	4.89	33062.70	4.54
	68.0 (20)	63881.63	3.69	61219.13	3.76	53366.68	4.07	48109.20	4.26	45060.30	4.44	32864.72	5.18	35401.80	5.15	41744.50	5.08	44281.58	5.06	39901.27	4.91	32600.75	4.67
	69.8 (21)	63089.71	3.77	61205.23	3.81	51782.83	4.05	46129.40	4.19	43186.09	4.39	31412.87	5.20	33480.66	5.17	38650.14	5.09	40717.94	5.06	37476.01	4.92	32072.80	4.70
	71.6 (22)	62561.76	3.84	61271.22	3.89	54818.53	4.14	50946.92	4.30	46762.93	4.48	30027.00	5.21	33194.69	5.18	41113.90	5.09	44281.58	5.06	39406.32	4.95	31280.88	4.77
	75.2 (24)	62165.80	3.98	59848.70	4.02	48263.18	4.21	41311.88	4.33	38513.76	4.52	27321.27	5.29	31046.24	5.24	40358.64	5.13	44083.60	5.09	38515.41	5.02	29235.08	4.91
1.6 + 1.6 + 1.6 + 1.6	60.8 (16)	67298.86	3.48	65914.85	3.57	58994.78	4.01	54842.75	4.27	52160.35	4.33	41430.77	4.59	40216.02	4.53	37179.16	4.38	35964.42	4.33	34564.22	4.18	32230.57	3.93
	64.4 (18)	64491.01	3.62	63060.53	3.71	55908.14	4.13	51616.70	4.38	49119.51	4.44	39130.72	4.68	38081.92	4.60	35459.93	4.42	34411.13	4.35	33884.66	4.22	33007.21	4.00
	68.0 (20)	63535.14	3.72	61859.06	3.80	53478.65	4.22	48450.40	4.47	46084.63	4.52	36621.57	4.70	35904.67	4.63	34112.43	4.45	33395.53	4.37	33283.51	4.28	33096.82	4.11
	69.8 (21)	63624.75	3.76	61739.58	3.82	52313.69	4.14	46658.15	4.32	44382.00	4.40	35277.39	4.72	34434.37	4.65	32326.82	4.47	31483.80	4.39	31999.07	4.31	32857.85	4.16
	71.6 (22)	64162.43	3.79	62396.73	3.87	53568.26	4.30	48271.18	4.55	45385.66	4.59	33843.59	4.74	33644.45	4.67	33146.61	4.49	32947.47	4.41	32757.04	4.34	32439.66	4.21
	75.2 (24)	66492.35	3.82	63797.34	3.91	50322.30	4.36	42237.28	4.62	39949.18	4.65	30796.77	4.79	31287.98	4.72	32516.00	4.54	33007.21	4.47	32312.71	4.41	31155.22	4.31
1.6 + 1.6 + 1.6 + 2.0	60.8 (16)	67298.86	3.47	65914.85	3.56	58994.78	4.00	54842.75	4.26	52160.35	4.32	41430.77	4.58	40216.02	4.52	37179.16	4.37	35964.42	4.32	34564.22	4.17	32230.57	3.92
	64.4 (18)	64491.01	3.61	63060.53	3.70	55908.14	4.12	51616.70	4.37	49119.51	4.43	39130.72	4.67	38081.92	4.59	35459.93	4.41	34411.13	4.34	33884.66	4.21	33007.21	3.99
	68.0 (20)	63535.14	3.71	61859.06	3.79	53478.65	4.21	48450.40	4.46	46084.63	4.51	36621.57	4.69	35904.67	4.62	34112.43	4.44	33395.53	4.36	33283.51	4.27	33096.82	4.10
	69.8 (21)	63624.75	3.75	61739.58	3.81	52313.69	4.13	46658.15	4.31	44382.00	4.39	35277.39	4.71	34434.37	4.64	32326.82	4.46	31483.80	4.38	31999.07	4.30	32857.85	4.15
	71.6 (22)	64162.43	3.78	62396.73	3.86	53568.26	4.29	48271.18	4.54	45385.66	4.58	33843.59	4.73	33644.45	4.66	33146.61	4.48	32947.47	4.41	32757.04	4.33	32439.66	4.20
	75.2 (24)	66492.35	3.81	63797.34	3.90	50322.30	4.35	42237.28	4.61	39949.18	4.64	30796.77	4.78	31287.98	4.71	32516.00	4.53	33007.21	4.46	32312.71	4.40	31155.22	4.30
1.6 + 1.6 + 1.6 + 2.5	60.8 (16)	67298.86	3.47	65914.85	3.56	58994.78	4.00	54842.75	4.26	52160.35	4.32	41430.77	4.58	40216.02	4.52	37179.16	4.37	35964.42	4.32	34564.22	4.17	32230.57	3.92
	64.4 (18)	64491.01	3.61	63060.53	3.70	55908.14	4.12	51616.70	4.37	49119.51	4.43	39130.72	4.67	38081.92	4.59	35459.93	4.41	34411.13	4.34	33884.66	4.21	33007.21	3.99
	68.0 (20)	63535.14	3.71	61859.06	3.79	53478.65	4.21	48450.40	4.46	46084.63	4.51	36621.57	4.69	35904.67	4.62	34112.43	4.44	33395.53	4.36	33283.51	4.27	33096.82	4.10
	69.8 (21)	63624.75	3.75	61739.58	3.81	52313.69	4.13	46658.15	4.31	44382.00	4.39	35277.39	4.71	34434.37	4.64	32326.82	4.46	31483.80	4.38	31999.07	4.30	32857.85	4.15
	71.6 (22)	64162.43	3.78	62396.73	3.86	53568.26	4.29	48271.18	4.54	45385.66	4.58	33843.59	4.73	33644.45	4.66	33146.61	4.48	32947.47	4.41	32757.04	4.33	32439.66	4.20
	75.2 (24)	66492.35	3.81	63797.34	3.90	50322.30	4.35	42237.28	4.61	39949.18	4.64	30796.77	4.78	31287.98	4.71	32516.00	4.53	33007.21	4.46	32312.71	4.40	31155.22	4.30
1.6 + 1.6 + 1.6 + 3.2	60.8 (16)	67298.86	3.39	65914.85	3.48	58994.78	3.91	54842.75	4.17	52160.35	4.23	41430.77	4.47	40216.02	4.42	37179.16	4.28	35964.42	4.22	34564.22	4.07	32230.57	3.83
	64.4 (18)	64491.01	3.53	63060.53	3.62	55908.14	4.03	51616.70	4.27	49119.51	4.33	39130.72	4.56	38081.92	4.49	35459.93	4.31	34411.13	4.24	33884.66	4.11	33007.21	3.90
	68.0 (20)	63535.14	3.63	61859.06	3.71	53478.65	4.12	48450.40	4.36	46084.63	4.40	36621.57	4.58	35904.67	4.51	34112.43	4.34	33395.53	4.27	33283.51	4.17	33096.82	4.01
	69.8 (21)	63624.75	3.67	61739.58	3.73	52313.69	4.03	46658.15	4.22	44382.00	4.29	35277.39	4.60	34434.37	4.53	32326.82	4.36	31483.80	4.29	31999.07	4.20	32857.85	4.06
	71.6 (22)	64162.43	3.69	62396.73	3.78	53568.26	4.19	48271.18	4.44	45385.66	4.48	33843.59	4.62	33644.45	4.55	33146.61	4.38	32947.47	4.31	32757.04	4.23	32439.66	4.10
	75.2 (24)	66492.35	3.73	63797.34	3.82	50322.30	4.25	42237.28	4.51	39949.18	4.54	30796.77	4.67	31287.98	4.60	32516.00	4.43	33007.21	4.36	32312.71	4.30	31155.22	4.21

Combination (Capacity)	Indoor Air Temp. °F (°C) DB	Outdoor Air Temp. °F (°C) WB																					
		60.8 (16)		59.0 (15)		50.0 (10)		44.6 (7)		42.8 (6)		35.6 (2)		32.0 (0)		23.0 (-5)		19.4 (-7)		14.0 (-10)		5.0 (-15)	
		Total Capacity (BTU/h)	Input Power (kW)	Total Capacity (BTU/h)	Input Power (kW)	Total Capacity (BTU/h)	Input Power (kW)	Total Capacity (BTU/h)	Input Power (kW)	Total Capacity (BTU/h)	Input Power (kW)	Total Capacity (BTU/h)	Input Power (kW)	Total Capacity (BTU/h)	Input Power (kW)	Total Capacity (BTU/h)	Input Power (kW)	Total Capacity (BTU/h)	Input Power (kW)	Total Capacity (BTU/h)	Input Power (kW)	Total Capacity (BTU/h)	Input Power (kW)
1.6 + 1.6 + 1.6 + 5.0	60.8 (16)	67298.86	3.26	65914.85	3.34	58994.78	3.76	54842.75	4.00	52160.35	4.06	41430.77	4.30	40216.02	4.25	37179.16	4.11	35964.42	4.05	34564.22	3.91	32230.57	3.68
	64.4 (18)	64491.01	3.40	63060.53	3.47	55908.14	3.87	51616.70	4.11	49119.51	4.16	39130.72	4.38	38081.92	4.31	35459.93	4.14	34411.13	4.07	33884.66	3.95	33007.21	3.75
	68.0 (20)	63535.14	3.49	61859.06	3.56	53478.65	3.96	48450.40	4.19	46084.63	4.23	36621.57	4.40	35904.67	4.34	34112.43	4.17	33395.53	4.10	33283.51	4.01	33096.82	3.85
	69.8 (21)	63624.75	3.53	61739.58	3.58	52313.69	3.88	46658.15	4.05	44382.00	4.13	35277.39	4.42	34434.37	4.35	32326.82	4.19	31483.80	4.12	31999.07	4.04	32857.85	3.90
	71.6 (22)	64162.43	3.55	62396.73	3.63	53568.26	4.03	48271.18	4.27	45385.66	4.30	33843.59	4.44	33644.45	4.37	33146.61	4.21	32947.47	4.14	32757.04	4.07	32439.66	3.94
	75.2 (24)	66492.35	3.58	63797.34	3.67	50322.30	4.08	42237.28	4.33	39949.18	4.36	30796.77	4.49	31287.98	4.42	32516.00	4.26	33007.21	4.19	32312.71	4.13	31155.22	4.04
1.6 + 1.6 + 1.6 + 7.0	60.8 (16)	19905.30	3.24	19495.94	3.33	17449.16	3.74	16221.09	3.98	15427.71	4.04	12254.17	4.28	11894.88	4.22	10996.65	4.09	10637.36	4.04	10223.22	3.90	9532.98	3.66
	64.4 (18)	19074.80	3.38	18651.71	3.46	16536.21	3.85	15266.91	4.09	14528.30	4.14	11573.87	4.36	11263.67	4.29	10488.15	4.12	10177.94	4.05	10022.22	3.93	9762.70	3.73
	68.0 (20)	18792.08	3.47	18296.34	3.55	15817.63	3.94	14330.40	4.17	13630.67	4.21	10831.73	4.38	10619.69	4.31	10089.59	4.15	9877.55	4.08	9844.42	3.99	9789.20	3.84
	69.8 (21)	18818.59	3.51	18261.00	3.57	15473.06	3.86	13800.30	4.03	13127.07	4.11	10434.16	4.40	10184.81	4.33	9561.45	4.17	9312.11	4.10	9464.51	4.02	9718.52	3.88
	71.6 (22)	18977.62	3.53	18455.37	3.61	15844.13	4.01	14277.39	4.25	13423.93	4.28	10010.08	4.42	9951.18	4.35	9803.93	4.19	9745.03	4.12	9688.70	4.05	9594.83	3.93
	75.2 (24)	19666.75	3.57	18869.64	3.65	14884.06	4.06	12492.72	4.31	11815.95	4.34	9108.90	4.47	9254.19	4.40	9617.41	4.24	9762.70	4.17	9557.28	4.11	9214.92	4.02
1.6 + 1.6 + 2.0 + 2.0	60.8 (16)	19905.30	3.41	19495.94	3.49	17449.16	3.93	16221.09	4.18	15427.71	4.25	12254.17	4.49	11894.88	4.44	10996.65	4.30	10637.36	4.24	10223.22	4.09	9532.98	3.85
	64.4 (18)	19074.80	3.55	18651.71	3.63	16536.21	4.04	15266.91	4.29	14528.30	4.35	11573.87	4.58	11263.67	4.51	10488.15	4.33	10177.94	4.26	10022.22	4.13	9762.70	3.92
	68.0 (20)	18792.08	3.64	18296.34	3.73	15817.63	4.13	14330.40	4.38	13630.67	4.42	10831.73	4.60	10619.69	4.53	10089.59	4.36	9877.55	4.29	9844.42	4.19	9789.20	4.03
	69.8 (21)	18818.59	3.68	18261.00	3.75	15473.06	4.05	13800.30	4.24	13127.07	4.31	10434.16	4.62	10184.81	4.55	9561.45	4.38	9312.11	4.31	9464.51	4.22	9718.52	4.08
	71.6 (22)	18977.62	3.71	18455.37	3.80	15844.13	4.21	14277.39	4.46	13423.93	4.50	10010.08	4.64	9951.18	4.57	9803.93	4.40	9745.03	4.33	9688.70	4.25	9594.83	4.12
	75.2 (24)	19666.75	3.75	18869.64	3.83	14884.06	4.27	12492.72	4.53	11815.95	4.56	9108.90	4.69	9254.19	4.62	9617.41	4.45	9762.70	4.38	9557.28	4.32	9214.92	4.22
1.6 + 1.6 + 2.0 + 2.5	60.8 (16)	67298.86	3.41	65914.85	3.49	58994.78	3.93	54842.75	4.18	52160.35	4.25	41430.77	4.49	40216.02	4.44	37179.16	4.30	35964.42	4.24	34564.22	4.09	32230.57	3.85
	64.4 (18)	64491.01	3.55	63060.53	3.63	55908.14	4.04	51616.70	4.29	49119.51	4.35	39130.72	4.58	38081.92	4.51	35459.93	4.33	34411.13	4.26	33884.66	4.13	33007.21	3.92
	68.0 (20)	63535.14	3.64	61859.06	3.73	53478.65	4.13	48450.40	4.38	46084.63	4.42	36621.57	4.60	35904.67	4.53	34112.43	4.36	33395.53	4.29	33283.51	4.19	33096.82	4.03
	69.8 (21)	63624.75	3.68	61739.58	3.75	52313.69	4.05	46658.15	4.24	44382.00	4.31	35277.39	4.62	34434.37	4.55	32326.82	4.38	31483.80	4.31	31999.07	4.22	32857.85	4.08
	71.6 (22)	64162.43	3.71	62396.73	3.80	53568.26	4.21	48271.18	4.46	45385.66	4.50	33843.59	4.64	33644.45	4.57	33146.61	4.40	32947.47	4.33	32757.04	4.25	32439.66	4.12
	75.2 (24)	66492.35	3.75	63797.34	3.83	50322.30	4.27	42237.28	4.53	39949.18	4.56	30796.77	4.69	31287.98	4.62	32516.00	4.45	33007.21	4.38	32312.71	4.32	31155.22	4.22
1.6 + 1.6 + 2.0 + 3.2	60.8 (16)	67298.86	3.38	65914.85	3.46	58994.78	3.89	54842.75	4.15	52160.35	4.21	41430.77	4.45	40216.02	4.40	37179.16	4.26	35964.42	4.20	34564.22	4.05	32230.57	3.81
	64.4 (18)	64491.01	3.52	63060.53	3.60	55908.14	4.01	51616.70	4.25	49119.51	4.31	39130.72	4.54	38081.92	4.47	35459.93	4.29	34411.13	4.22	33884.66	4.09	33007.21	3.89
	68.0 (20)	63535.14	3.61	61859.06	3.69	53478.65	4.10	48450.40	4.34	46084.63	4.38	36621.57	4.56	35904.67	4.49	34112.43	4.32	33395.53	4.25	33283.51	4.15	33096.82	3.99
	69.8 (21)	63624.75	3.65	61739.58	3.71	52313.69	4.02	46658.15	4.20	44382.00	4.27	35277.39	4.58	34434.37	4.51	32326.82	4.34	31483.80	4.27	31999.07	4.18	32857.85	4.04
	71.6 (22)	64162.43	3.68	62396.73	3.76	53568.26	4.17	48271.18	4.42	45385.66	4.46	33843.59	4.60	33644.45	4.53	33146.61	4.36	32947.47	4.29	32757.04	4.21	32439.66	4.09
	75.2 (24)	66492.35	3.71	63797.34	3.80	50322.30	4.23	42237.28	4.49	39949.18	4.52	30796.77	4.65	31287.98	4.58	32516.00	4.41	33007.21	4.34	32312.71	4.28	31155.22	4.19
1.6 + 1.6 + 2.0 + 5.0	60.8 (16)	67298.86	3.24	65914.85	3.33	58994.78	3.74	54842.75	3.98	52160.35	4.04	41430.77	4.28	40216.02	4.22	37179.16	4.09	35964.42	4.04	34564.22	3.90	32230.57	3.66
	64.4 (18)	64491.01	3.38	63060.53	3.46	55908.14	3.85	51616.70	4.09	49119.51	4.14	39130.72	4.36	38081.92	4.29	35459.93	4.12	34411.13	4.05	33884.66	3.93	33007.21	3.73
	68.0 (20)	63535.14	3.47	61859.06	3.55	53478.65	3.94	48450.40	4.17	46084.63	4.21	36621.57	4.38	35904.67	4.31	34112.43	4.15	33395.53	4.08	33283.51	3.99	33096.82	3.84
	69.8 (21)	63624.75	3.51	61739.58	3.57	52313.69	3.86	46658.15	4.03	44382.00	4.11	35277.39	4.40	34434.37	4.33	32326.82	4.17	31483.80	4.10	31999.07	4.02	32857.85	3.88
	71.6 (22)	64162.43	3.53	62396.73	3.61	53568.26	4.01	48271.18	4.25	45385.66	4.28	33843.59	4.42	33644.45	4.35	33146.61	4.19	32947.47	4.12	32757.04	4.05	32439.66	3.93
	75.2 (24)	66492.35	3.57	63797.34	3.65	50322.30	4.06	42237.28	4.31	39949.18	4.34	30796.77	4.47	31287.98	4.40	32516.00	4.24	33007.21	4.17	32312.71	4.11	31155.22	4.02

Combination (Capacity)	Indoor Air Temp. °F (°C) DB	Outdoor Air Temp. °F (°C) WB																							
		60.8 (16)		59.0 (15)		50.0 (10)		44.6 (7)		42.8 (6)		35.6 (2)		32.0 (0)		23.0 (-5)		19.4 (-7)		14.0 (-10)		5.0 (-15)			
		Total Capacity (BTU/h)	Input Power (kW)	Total Capacity (BTU/h)	Input Power (kW)	Total Capacity (BTU/h)	Input Power (kW)	Total Capacity (BTU/h)	Input Power (kW)	Total Capacity (BTU/h)	Input Power (kW)	Total Capacity (BTU/h)	Input Power (kW)	Total Capacity (BTU/h)	Input Power (kW)	Total Capacity (BTU/h)	Input Power (kW)	Total Capacity (BTU/h)	Input Power (kW)	Total Capacity (BTU/h)	Input Power (kW)	Total Capacity (BTU/h)	Input Power (kW)		
1.6 + 1.6 + 2.0 + 7.0	60.8 (16)	67298.86	3.23	65914.85	3.31	58994.78	3.72	54842.75	3.96	52160.35	4.02	41430.77	4.26	40216.02	4.20	37179.16	4.07	35964.42	4.02	34564.22	3.88	32230.57	3.64		
	64.4 (18)	64491.01	3.36	63060.53	3.44	55908.14	3.83	51616.70	4.07	49119.51	4.12	39130.72	4.34	38081.92	4.27	35459.93	4.10	34411.13	4.03	33884.66	3.92	33007.21	3.72		
	68.0 (20)	63535.14	3.45	61859.06	3.53	53478.65	3.92	48450.40	4.15	46084.63	4.19	36621.57	4.36	35904.67	4.29	34112.43	4.13	33395.53	4.06	33283.51	3.97	33096.82	3.82		
	69.8 (21)	63624.75	3.49	61739.58	3.55	52313.69	3.84	46658.15	4.01	44382.00	4.09	35277.39	4.38	34434.37	4.31	32326.82	4.15	31483.80	4.08	31999.07	4.00	32857.85	3.86		
	71.6 (22)	64162.43	3.52	62396.73	3.60	53568.26	3.99	48271.18	4.23	45385.66	4.26	33843.59	4.40	33644.45	4.33	33146.61	4.17	32947.47	4.10	32757.04	4.03	32439.66	3.91		
	75.2 (24)	66492.35	3.55	63797.34	3.63	50322.30	4.04	42237.28	4.29	39949.18	4.32	30796.77	4.44	31287.98	4.38	32516.00	4.22	33007.21	4.15	32312.71	4.09	31155.22	4.00		
1.6 + 1.6 + 2.5 + 2.5	60.8 (16)	67298.86	3.41	65914.85	3.49	58994.78	3.93	54842.75	4.18	52160.35	4.25	41430.77	4.49	40216.02	4.44	37179.16	4.30	35964.42	4.24	34564.22	4.09	32230.57	3.85		
	64.4 (18)	64491.01	3.55	63060.53	3.63	55908.14	4.04	51616.70	4.29	49119.51	4.35	39130.72	4.58	38081.92	4.51	35459.93	4.33	34411.13	4.26	33884.66	4.13	33007.21	3.92		
	68.0 (20)	63535.14	3.64	61859.06	3.73	53478.65	4.13	48450.40	4.38	46084.63	4.42	36621.57	4.60	35904.67	4.53	34112.43	4.36	33395.53	4.29	33283.51	4.19	33096.82	4.03		
	69.8 (21)	63624.75	3.68	61739.58	3.75	52313.69	4.05	46658.15	4.24	44382.00	4.31	35277.39	4.62	34434.37	4.55	32326.82	4.38	31483.80	4.31	31999.07	4.22	32857.85	4.08		
	71.6 (22)	64162.43	3.71	62396.73	3.80	53568.26	4.21	48271.18	4.46	45385.66	4.50	33843.59	4.64	33644.45	4.57	33146.61	4.40	32947.47	4.33	32757.04	4.25	32439.66	4.12		
	75.2 (24)	66492.35	3.75	63797.34	3.83	50322.30	4.27	42237.28	4.53	39949.18	4.56	30796.77	4.69	31287.98	4.62	32516.00	4.45	33007.21	4.38	32312.71	4.32	31155.22	4.22		
1.6 + 1.6 + 2.5 + 3.2	60.8 (16)	67298.86	3.38	65914.85	3.46	58994.78	3.89	54842.75	4.15	52160.35	4.21	41430.77	4.45	40216.02	4.40	37179.16	4.26	35964.42	4.20	34564.22	4.05	32230.57	3.81		
	64.4 (18)	64491.01	3.52	63060.53	3.60	55908.14	4.01	51616.70	4.25	49119.51	4.31	39130.72	4.54	38081.92	4.47	35459.93	4.29	34411.13	4.22	33884.66	4.09	33007.21	3.89		
	68.0 (20)	63535.14	3.61	61859.06	3.69	53478.65	4.10	48450.40	4.34	46084.63	4.38	36621.57	4.56	35904.67	4.49	34112.43	4.32	33395.53	4.25	33283.51	4.15	33096.82	3.99		
	69.8 (21)	63624.75	3.65	61739.58	3.71	52313.69	4.02	46658.15	4.20	44382.00	4.27	35277.39	4.58	34434.37	4.51	32326.82	4.34	31483.80	4.27	31999.07	4.18	32857.85	4.04		
	71.6 (22)	64162.43	3.68	62396.73	3.76	53568.26	4.17	48271.18	4.42	45385.66	4.46	33843.59	4.60	33644.45	4.53	33146.61	4.36	32947.47	4.29	32757.04	4.21	32439.66	4.09		
	75.2 (24)	66492.35	3.71	63797.34	3.80	50322.30	4.23	42237.28	4.49	39949.18	4.52	30796.77	4.65	31287.98	4.58	32516.00	4.41	33007.21	4.34	32312.71	4.28	31155.22	4.19		
1.6 + 1.6 + 2.5 + 5.0	60.8 (16)	67298.86	3.24	65914.85	3.33	58994.78	3.74	54842.75	3.98	52160.35	4.04	41430.77	4.28	40216.02	4.22	37179.16	4.09	35964.42	4.04	34564.22	3.90	32230.57	3.66		
	64.4 (18)	64491.01	3.38	63060.53	3.46	55908.14	3.85	51616.70	4.09	49119.51	4.14	39130.72	4.36	38081.92	4.29	35459.93	4.12	34411.13	4.05	33884.66	3.93	33007.21	3.73		
	68.0 (20)	63535.14	3.47	61859.06	3.55	53478.65	3.94	48450.40	4.17	46084.63	4.21	36621.57	4.38	35904.67	4.31	34112.43	4.15	33395.53	4.08	33283.51	3.99	33096.82	3.84		
	69.8 (21)	63624.75	3.51	61739.58	3.57	52313.69	3.86	46658.15	4.03	44382.00	4.11	35277.39	4.40	34434.37	4.33	32326.82	4.17	31483.80	4.10	31999.07	4.02	32857.85	3.88		
	71.6 (22)	64162.43	3.53	62396.73	3.61	53568.26	4.01	48271.18	4.25	45385.66	4.28	33843.59	4.42	33644.45	4.35	33146.61	4.19	32947.47	4.12	32757.04	4.05	32439.66	3.93		
	75.2 (24)	66492.35	3.57	63797.34	3.65	50322.30	4.06	42237.28	4.31	39949.18	4.34	30796.77	4.47	31287.98	4.40	32516.00	4.24	33007.21	4.17	32312.71	4.11	31155.22	4.02		
1.6 + 1.6 + 2.5 + 7.0	60.8 (16)	67298.86	3.23	65914.85	3.31	58994.78	3.72	54842.75	3.96	52160.35	4.02	41430.77	4.26	40216.02	4.20	37179.16	4.07	35964.42	4.02	34564.22	3.88	32230.57	3.64		
	64.4 (18)	64491.01	3.36	63060.53	3.44	55908.14	3.83	51616.70	4.07	49119.51	4.12	39130.72	4.34	38081.92	4.27	35459.93	4.10	34411.13	4.03	33884.66	3.92	33007.21	3.72		
	68.0 (20)	63535.14	3.45	61859.06	3.53	53478.65	3.92	48450.40	4.15	46084.63	4.19	36621.57	4.36	35904.67	4.29	34112.43	4.13	33395.53	4.06	33283.51	3.97	33096.82	3.82		
	69.8 (21)	63624.75	3.49	61739.58	3.55	52313.69	3.84	46658.15	4.01	44382.00	4.09	35277.39	4.38	34434.37	4.31	32326.82	4.15	31483.80	4.08	31999.07	4.00	32857.85	3.86		
	71.6 (22)	64162.43	3.52	62396.73	3.60	53568.26	3.99	48271.18	4.23	45385.66	4.26	33843.59	4.40	33644.45	4.33	33146.61	4.17	32947.47	4.10	32757.04	4.03	32439.66	3.91		
	75.2 (24)	66492.35	3.55	63797.34	3.63	50322.30	4.04	42237.28	4.29	39949.18	4.32	30796.77	4.44	31287.98	4.38	32516.00	4.22	33007.21	4.15	32312.71	4.09	31155.22	4.00		
1.6 + 1.6 + 3.2 + 3.2	60.8 (16)	67298.86	3.35	65914.85	3.44	58994.78	3.86	54842.75	4.12	52160.35	4.18	41430.77	4.42	40216.02	4.37	37179.16	4.23	35964.42	4.17	34564.22	4.03	32230.57	3.79		
	64.4 (18)	64491.01	3.49	63060.53	3.57	55908.14	3.98	51616.70	4.22	49119.51	4.28	39130.72	4.51	38081.92	4.44	35459.93	4.26	34411.13	4.19	33884.66	4.07	33007.21	3.86		
	68.0 (20)	63535.14	3.59	61859.06	3.67	53478.65	4.07	48450.40	4.31	46084.63	4.35	36621.57	4.53	35904.67	4.46	34112.43	4.29	33395.53	4.22	33283.51	4.12	33096.82	3.96		
	69.8 (21)	63624.75	3.63	61739.58	3.69	52313.69	3.99	46658.15	4.17	44382.00	4.24	35277.39	4.55	34434.37	4.48	32326.82	4.31	31483.80	4.24	31999.07	4.15	32857.85	4.01		
	71.6 (22)	64162.43	3.65	62396.73	3.73	53568.26	4.14	48271.18	4.39	45385.66	4.43	33843.59	4.57	33644.45	4.50	33146.61	4.33	32947.47	4.26	32757.04	4.18	32439.66	4.06		
	75.2 (24)	66492.35	3.69	63797.34	3.77	50322.30	4.20	42237.28	4.46	39949.18	4.49	30796.77	4.62	31287.98	4.55	32516.00	4.38	33007.21	4.31	32312.71	4.25	31155.22	4.16		

Combination (Capacity)	Indoor Air Temp. °F (°C) DB	Outdoor Air Temp. °F (°C) WB																					
		60.8 (16)		59.0 (15)		50.0 (10)		44.6 (7)		42.8 (6)		35.6 (2)		32.0 (0)		23.0 (-5)		19.4 (-7)		14.0 (-10)		5.0 (-15)	
		Total Capacity (BTU/h)	Input Power (kW)	Total Capacity (BTU/h)	Input Power (kW)	Total Capacity (BTU/h)	Input Power (kW)	Total Capacity (BTU/h)	Input Power (kW)	Total Capacity (BTU/h)	Input Power (kW)	Total Capacity (BTU/h)	Input Power (kW)	Total Capacity (BTU/h)	Input Power (kW)	Total Capacity (BTU/h)	Input Power (kW)	Total Capacity (BTU/h)	Input Power (kW)	Total Capacity (BTU/h)	Input Power (kW)	Total Capacity (BTU/h)	Input Power (kW)
1.6 + 1.6 + 3.2 + 5.0	60.8 (16)	67298.86	3.22	65914.85	3.30	58994.78	3.71	54842.75	3.96	52160.35	4.01	41430.77	4.25	40216.02	4.19	37179.16	4.06	35964.42	4.01	34564.22	3.87	32230.57	3.64
	64.4 (18)	64491.01	3.36	63060.53	3.43	55908.14	3.82	51616.70	4.06	49119.51	4.11	39130.72	4.33	38081.92	4.26	35459.93	4.09	34411.13	4.03	33884.66	3.91	33007.21	3.71
	68.0 (20)	63535.14	3.44	61859.06	3.52	53478.65	3.91	48450.40	4.14	46084.63	4.18	36621.57	4.35	35904.67	4.28	34112.43	4.12	33395.53	4.05	33283.51	3.96	33096.82	3.81
	69.8 (21)	63624.75	3.48	61739.58	3.54	52313.69	3.83	46658.15	4.00	44382.00	4.08	35277.39	4.37	34434.37	4.30	32326.82	4.14	31483.80	4.07	31999.07	3.99	32857.85	3.85
	71.6 (22)	64162.43	3.51	62396.73	3.59	53568.26	3.98	48271.18	4.22	45385.66	4.25	33843.59	4.39	33644.45	4.32	33146.61	4.16	32947.47	4.09	32757.04	4.02	32439.66	3.90
	75.2 (24)	66492.35	3.54	63797.34	3.62	50322.30	4.03	42237.28	4.28	39949.18	4.31	30796.77	4.43	31287.98	4.37	32516.00	4.21	33007.21	4.14	32312.71	4.08	31155.22	3.99
1.6 + 1.6 + 3.2 + 7.0	60.8 (16)	68246.73	3.30	66843.23	3.38	59825.70	3.80	55615.18	4.05	52895.00	4.11	42014.30	4.35	40782.45	4.30	37702.81	4.16	36470.96	4.10	35051.04	3.96	32684.52	3.72
	64.4 (18)	65399.33	3.44	63948.71	3.52	56695.58	3.92	52343.70	4.16	49811.33	4.21	39681.85	4.44	38618.29	4.37	35959.37	4.19	34895.80	4.12	34361.91	4.00	33472.10	3.80
	68.0 (20)	64430.00	3.53	62730.31	3.61	54231.87	4.00	49132.80	4.24	46733.71	4.28	37137.37	4.46	36410.37	4.39	34592.88	4.22	33865.89	4.15	33752.29	4.06	33562.97	3.90
	69.8 (21)	64520.88	3.57	62609.15	3.63	53050.50	3.92	47315.31	4.10	45007.10	4.18	35774.25	4.48	34919.36	4.41	32782.13	4.24	31927.23	4.17	32449.76	4.08	33320.64	3.95
	71.6 (22)	65066.12	3.59	63275.56	3.67	54322.74	4.08	48951.05	4.32	46024.89	4.35	34320.26	4.49	34118.32	4.43	33613.46	4.26	33411.52	4.19	33218.41	4.11	32896.56	3.99
	75.2 (24)	67428.86	3.63	64695.90	3.71	51031.07	4.13	42832.17	4.38	40511.84	4.42	31230.53	4.54	31728.65	4.47	32973.97	4.31	33472.10	4.24	32767.82	4.18	31594.03	4.09
1.6 + 1.6 + 5.0 + 5.0	60.8 (16)	68246.73	3.24	66843.23	3.32	59825.70	3.73	55615.18	3.97	52895.00	4.03	42014.30	4.27	40782.45	4.21	37702.81	4.08	36470.96	4.03	35051.04	3.89	32684.52	3.65
	64.4 (18)	65399.33	3.37	63948.71	3.45	56695.58	3.84	52343.70	4.08	49811.33	4.13	39681.85	4.35	38618.29	4.28	35959.37	4.11	34895.80	4.04	34361.91	3.92	33472.10	3.72
	68.0 (20)	64430.00	3.46	62730.31	3.54	54231.87	3.93	49132.80	4.16	46733.71	4.20	37137.37	4.37	36410.37	4.30	34592.88	4.14	33865.89	4.07	33752.29	3.98	33562.97	3.83
	69.8 (21)	64520.88	3.50	62609.15	3.56	53050.50	3.85	47315.31	4.02	45007.10	4.10	35774.25	4.39	34919.36	4.32	32782.13	4.16	31927.23	4.09	32449.76	4.01	33320.64	3.87
	71.6 (22)	65066.12	3.53	63275.56	3.60	54322.74	4.00	48951.05	4.24	46024.89	4.27	34320.26	4.41	34118.32	4.34	33613.46	4.18	33411.52	4.11	33218.41	4.04	32896.56	3.92
	75.2 (24)	67428.86	3.56	64695.90	3.64	51031.07	4.05	42832.17	4.30	40511.84	4.33	31230.53	4.45	31728.65	4.39	32973.97	4.23	33472.10	4.16	32767.82	4.10	31594.03	4.01
1.6 + 2.0 + 2.0 + 2.0	60.8 (16)	67298.86	3.40	65914.85	3.49	58994.78	3.92	54842.75	4.17	52160.35	4.24	41430.77	4.48	40216.02	4.43	37179.16	4.29	35964.42	4.23	34564.22	4.08	32230.57	3.84
	64.4 (18)	64491.01	3.54	63060.53	3.62	55908.14	4.04	51616.70	4.28	49119.51	4.34	39130.72	4.57	38081.92	4.50	35459.93	4.32	34411.13	4.25	33884.66	4.12	33007.21	3.91
	68.0 (20)	63535.14	3.64	61859.06	3.72	53478.65	4.13	48450.40	4.37	46084.63	4.41	36621.57	4.59	35904.67	4.52	34112.43	4.35	33395.53	4.28	33283.51	4.18	33096.82	4.02
	69.8 (21)	63624.75	3.68	61739.58	3.74	52313.69	4.04	46658.15	4.23	44382.00	4.30	35277.39	4.61	34434.37	4.54	32326.82	4.37	31483.80	4.30	31999.07	4.21	32857.85	4.07
	71.6 (22)	64162.43	3.70	62396.73	3.79	53568.26	4.20	48271.18	4.45	45385.66	4.49	33843.59	4.63	33644.45	4.56	33146.61	4.39	32947.47	4.32	32757.04	4.24	32439.66	4.11
	75.2 (24)	66492.35	3.74	63797.34	3.82	50322.30	4.26	42237.28	4.52	39949.18	4.55	30796.77	4.68	31287.98	4.61	32516.00	4.44	33007.21	4.37	32312.71	4.31	31155.22	4.22
1.6 + 2.0 + 2.0 + 2.5	60.8 (16)	67298.86	3.40	65914.85	3.49	58994.78	3.92	54842.75	4.17	52160.35	4.24	41430.77	4.48	40216.02	4.43	37179.16	4.29	35964.42	4.23	34564.22	4.08	32230.57	3.84
	64.4 (18)	64491.01	3.54	63060.53	3.62	55908.14	4.04	51616.70	4.28	49119.51	4.34	39130.72	4.57	38081.92	4.50	35459.93	4.32	34411.13	4.25	33884.66	4.12	33007.21	3.91
	68.0 (20)	63535.14	3.64	61859.06	3.72	53478.65	4.13	48450.40	4.37	46084.63	4.41	36621.57	4.59	35904.67	4.52	34112.43	4.35	33395.53	4.28	33283.51	4.18	33096.82	4.02
	69.8 (21)	63624.75	3.68	61739.58	3.74	52313.69	4.04	46658.15	4.23	44382.00	4.30	35277.39	4.61	34434.37	4.54	32326.82	4.37	31483.80	4.30	31999.07	4.21	32857.85	4.07
	71.6 (22)	64162.43	3.70	62396.73	3.79	53568.26	4.20	48271.18	4.45	45385.66	4.49	33843.59	4.63	33644.45	4.56	33146.61	4.39	32947.47	4.32	32757.04	4.24	32439.66	4.11
	75.2 (24)	66492.35	3.74	63797.34	3.82	50322.30	4.26	42237.28	4.52	39949.18	4.55	30796.77	4.68	31287.98	4.61	32516.00	4.44	33007.21	4.37	32312.71	4.31	31155.22	4.22
1.6 + 2.0 + 2.0 + 3.2	60.8 (16)	67298.86	3.37	65914.85	3.45	58994.78	3.88	54842.75	4.14	52160.35	4.20	41430.77	4.44	40216.02	4.39	37179.16	4.25	35964.42	4.19	34564.22	4.04	32230.57	3.80
	64.4 (18)	64491.01	3.51	63060.53	3.59	55908.14	4.00	51616.70	4.24	49119.51	4.30	39130.72	4.53	38081.92	4.46	35459.93	4.28	34411.13	4.21	33884.66	4.08	33007.21	3.88
	68.0 (20)	63535.14	3.60	61859.06	3.68	53478.65	4.09	48450.40	4.33	46084.63	4.37	36621.57	4.55	35904.67	4.48	34112.43	4.31	33395.53	4.24	33283.51	4.14	33096.82	3.98
	69.8 (21)	63624.75	3.64	61739.58	3.70	52313.69	4.01	46658.15	4.19	44382.00	4.26	35277.39	4.57	34434.37	4.50	32326.82	4.33	31483.80	4.26	31999.07	4.17	32857.85	4.03
	71.6 (22)	64162.43	3.67	62396.73	3.75	53568.26	4.16	48271.18	4.41	45385.66	4.45	33843.59	4.59	33644.45	4.52	33146.61	4.35	32947.47	4.28	32757.04	4.20	32439.66	4.08
	75.2 (24)	66492.35	3.70	63797.34	3.79	50322.30	4.22	42237.28	4.48	39949.18	4.51	30796.77	4.64	31287.98	4.57	32516.00	4.40	33007.21	4.33	32312.71	4.27	31155.22	4.18

Combination (Capacity)	Indoor Air Temp. °F (°C) DB	Outdoor Air Temp. °F (°C) WB																					
		60.8 (16)		59.0 (15)		50.0 (10)		44.6 (7)		42.8 (6)		35.6 (2)		32.0 (0)		23.0 (-5)		19.4 (-7)		14.0 (-10)		5.0 (-15)	
		Total Capacity (BTU/h)	Input Power (kW)	Total Capacity (BTU/h)	Input Power (kW)	Total Capacity (BTU/h)	Input Power (kW)	Total Capacity (BTU/h)	Input Power (kW)	Total Capacity (BTU/h)	Input Power (kW)	Total Capacity (BTU/h)	Input Power (kW)	Total Capacity (BTU/h)	Input Power (kW)	Total Capacity (BTU/h)	Input Power (kW)	Total Capacity (BTU/h)	Input Power (kW)	Total Capacity (BTU/h)	Input Power (kW)	Total Capacity (BTU/h)	Input Power (kW)
1.6 + 2.0 + 2.0 + 5.0	60.8 (16)	67298.86	3.24	65914.85	3.32	58994.78	3.73	54842.75	3.97	52160.35	4.03	41430.77	4.27	40216.02	4.21	37179.16	4.08	35964.42	4.03	34564.22	3.89	32230.57	3.65
	64.4 (18)	64491.01	3.37	63060.53	3.45	55908.14	3.84	51616.70	4.08	49119.51	4.13	39130.72	4.35	38081.92	4.28	35459.93	4.11	34411.13	4.04	33884.66	3.92	33007.21	3.72
	68.0 (20)	63535.14	3.46	61859.06	3.54	53478.65	3.93	48450.40	4.16	46084.63	4.20	36621.57	4.37	35904.67	4.30	34112.43	4.14	33395.53	4.07	33283.51	3.98	33096.82	3.83
	69.8 (21)	63624.75	3.50	61739.58	3.56	52313.69	3.85	46658.15	4.02	44382.00	4.10	35277.39	4.39	34434.37	4.32	32326.82	4.16	31483.80	4.09	31999.07	4.01	32857.85	3.87
	71.6 (22)	64162.43	3.53	62396.73	3.60	53568.26	4.00	48271.18	4.24	45385.66	4.27	33843.59	4.41	33644.45	4.34	33146.61	4.18	32947.47	4.11	32757.04	4.04	32439.66	3.92
	75.2 (24)	66492.35	3.56	63797.34	3.64	50322.30	4.05	42237.28	4.30	39949.18	4.33	30796.77	4.45	31287.98	4.39	32516.00	4.23	33007.21	4.16	32312.71	4.10	31155.22	4.01
1.6 + 2.0 + 2.0 + 7.0	60.8 (16)	67298.86	3.22	65914.85	3.30	58994.78	3.71	54842.75	3.96	52160.35	4.01	41430.77	4.25	40216.02	4.19	37179.16	4.06	35964.42	4.01	34564.22	3.87	32230.57	3.64
	64.4 (18)	64491.01	3.36	63060.53	3.43	55908.14	3.82	51616.70	4.06	49119.51	4.11	39130.72	4.33	38081.92	4.26	35459.93	4.09	34411.13	4.03	33884.66	3.91	33007.21	3.71
	68.0 (20)	63535.14	3.44	61859.06	3.52	53478.65	3.91	48450.40	4.14	46084.63	4.18	36621.57	4.35	35904.67	4.28	34112.43	4.12	33395.53	4.05	33283.51	3.96	33096.82	3.81
	69.8 (21)	63624.75	3.48	61739.58	3.54	52313.69	3.83	46658.15	4.00	44382.00	4.08	35277.39	4.37	34434.37	4.30	32326.82	4.14	31483.80	4.07	31999.07	3.99	32857.85	3.85
	71.6 (22)	64162.43	3.51	62396.73	3.59	53568.26	3.98	48271.18	4.22	45385.66	4.25	33843.59	4.39	33644.45	4.32	33146.61	4.16	32947.47	4.09	32757.04	4.02	32439.66	3.90
	75.2 (24)	66492.35	3.54	63797.34	3.62	50322.30	4.03	42237.28	4.28	39949.18	4.31	30796.77	4.43	31287.98	4.37	32516.00	4.21	33007.21	4.14	32312.71	4.08	31155.22	3.99
1.6 + 2.0 + 2.5 + 2.5	60.8 (16)	67298.86	3.40	65914.85	3.49	58994.78	3.92	54842.75	4.17	52160.35	4.24	41430.77	4.48	40216.02	4.43	37179.16	4.29	35964.42	4.23	34564.22	4.08	32230.57	3.84
	64.4 (18)	64491.01	3.54	63060.53	3.62	55908.14	4.04	51616.70	4.28	49119.51	4.34	39130.72	4.57	38081.92	4.50	35459.93	4.32	34411.13	4.25	33884.66	4.12	33007.21	3.91
	68.0 (20)	63535.14	3.64	61859.06	3.72	53478.65	4.13	48450.40	4.37	46084.63	4.41	36621.57	4.59	35904.67	4.52	34112.43	4.35	33395.53	4.28	33283.51	4.18	33096.82	4.02
	69.8 (21)	63624.75	3.68	61739.58	3.74	52313.69	4.04	46658.15	4.23	44382.00	4.30	35277.39	4.61	34434.37	4.54	32326.82	4.37	31483.80	4.30	31999.07	4.21	32857.85	4.07
	71.6 (22)	64162.43	3.70	62396.73	3.79	53568.26	4.20	48271.18	4.45	45385.66	4.49	33843.59	4.63	33644.45	4.56	33146.61	4.39	32947.47	4.32	32757.04	4.24	32439.66	4.11
	75.2 (24)	66492.35	3.74	63797.34	3.82	50322.30	4.26	42237.28	4.52	39949.18	4.55	30796.77	4.68	31287.98	4.61	32516.00	4.44	33007.21	4.37	32312.71	4.31	31155.22	4.22
1.6 + 2.0 + 2.5 + 3.2	60.8 (16)	67298.86	3.37	65914.85	3.45	58994.78	3.88	54842.75	4.14	52160.35	4.20	41430.77	4.44	40216.02	4.39	37179.16	4.25	35964.42	4.19	34564.22	4.04	32230.57	3.80
	64.4 (18)	64491.01	3.51	63060.53	3.59	55908.14	4.00	51616.70	4.24	49119.51	4.30	39130.72	4.53	38081.92	4.46	35459.93	4.28	34411.13	4.21	33884.66	4.08	33007.21	3.88
	68.0 (20)	63535.14	3.60	61859.06	3.68	53478.65	4.09	48450.40	4.33	46084.63	4.37	36621.57	4.55	35904.67	4.48	34112.43	4.31	33395.53	4.24	33283.51	4.14	33096.82	3.98
	69.8 (21)	63624.75	3.64	61739.58	3.70	52313.69	4.01	46658.15	4.19	44382.00	4.26	35277.39	4.57	34434.37	4.50	32326.82	4.33	31483.80	4.26	31999.07	4.17	32857.85	4.03
	71.6 (22)	64162.43	3.67	62396.73	3.75	53568.26	4.16	48271.18	4.41	45385.66	4.45	33843.59	4.59	33644.45	4.52	33146.61	4.35	32947.47	4.28	32757.04	4.20	32439.66	4.08
	75.2 (24)	66492.35	3.70	63797.34	3.79	50322.30	4.22	42237.28	4.48	39949.18	4.51	30796.77	4.64	31287.98	4.57	32516.00	4.40	33007.21	4.33	32312.71	4.27	31155.22	4.18
1.6 + 2.0 + 2.5 + 5.0	60.8 (16)	67298.86	3.24	65914.85	3.32	58994.78	3.73	54842.75	3.97	52160.35	4.03	41430.77	4.27	40216.02	4.21	37179.16	4.08	35964.42	4.03	34564.22	3.89	32230.57	3.65
	64.4 (18)	64491.01	3.37	63060.53	3.45	55908.14	3.84	51616.70	4.08	49119.51	4.13	39130.72	4.35	38081.92	4.28	35459.93	4.11	34411.13	4.04	33884.66	3.92	33007.21	3.72
	68.0 (20)	63535.14	3.46	61859.06	3.54	53478.65	3.93	48450.40	4.16	46084.63	4.20	36621.57	4.37	35904.67	4.30	34112.43	4.14	33395.53	4.07	33283.51	3.98	33096.82	3.83
	69.8 (21)	63624.75	3.50	61739.58	3.56	52313.69	3.85	46658.15	4.02	44382.00	4.10	35277.39	4.39	34434.37	4.32	32326.82	4.16	31483.80	4.09	31999.07	4.01	32857.85	3.87
	71.6 (22)	64162.43	3.53	62396.73	3.60	53568.26	4.00	48271.18	4.24	45385.66	4.27	33843.59	4.41	33644.45	4.34	33146.61	4.18	32947.47	4.11	32757.04	4.04	32439.66	3.92
	75.2 (24)	66492.35	3.56	63797.34	3.64	50322.30	4.05	42237.28	4.30	39949.18	4.33	30796.77	4.45	31287.98	4.39	32516.00	4.23	33007.21	4.16	32312.71	4.10	31155.22	4.01
1.6 + 2.0 + 2.5 + 7.0	60.8 (16)	68246.73	3.31	66843.23	3.40	59825.70	3.82	55615.18	4.07	52895.00	4.13	42014.30	4.37	40782.45	4.32	37702.81	4.18	36470.96	4.12	35051.04	3.98	32684.52	3.74
	64.4 (18)	65399.33	3.45	63948.71	3.53	56695.58	3.93	52343.70	4.17	49811.33	4.23	39681.85	4.46	38618.29	4.39	35959.37	4.21	34895.80	4.14	34361.91	4.02	33472.10	3.81
	68.0 (20)	64430.00	3.54	62730.31	3.62	54231.87	4.02	49132.80	4.26	46733.71	4.30	37137.37	4.48	36410.37	4.41	34592.88	4.24	33865.89	4.17	33752.29	4.07	33562.97	3.92
	69.8 (21)	64520.88	3.58	62609.15	3.64	53050.50	3.94	47315.31	4.12	45007.10	4.20	35774.25	4.50	34919.36	4.43	32782.13	4.26	31927.23	4.19	32449.76	4.10	33320.64	3.96
	71.6 (22)	65066.12	3.61	63275.56	3.69	54322.74	4.10	48951.05	4.34	46024.89	4.37	34320.26	4.52	34118.32	4.45	33613.46	4.28	33411.52	4.21	33218.41	4.13	32896.56	4.01
	75.2 (24)	67428.86	3.64	64695.90	3.73	51031.07	4.15	42832.17	4.40	40511.84	4.44	31230.53	4.56	31728.65	4.49	32973.97	4.33	33472.10	4.26	32767.82	4.20	31594.03	4.11

Combination (Capacity)	Indoor Air Temp. °F (°C) DB	Outdoor Air Temp. °F (°C) WB																					
		60.8 (16)		59.0 (15)		50.0 (10)		44.6 (7)		42.8 (6)		35.6 (2)		32.0 (0)		23.0 (-5)		19.4 (-7)		14.0 (-10)		5.0 (-15)	
		Total Capacity (BTU/h)	Input Power (kW)	Total Capacity (BTU/h)	Input Power (kW)	Total Capacity (BTU/h)	Input Power (kW)	Total Capacity (BTU/h)	Input Power (kW)	Total Capacity (BTU/h)	Input Power (kW)	Total Capacity (BTU/h)	Input Power (kW)	Total Capacity (BTU/h)	Input Power (kW)	Total Capacity (BTU/h)	Input Power (kW)	Total Capacity (BTU/h)	Input Power (kW)	Total Capacity (BTU/h)	Input Power (kW)	Total Capacity (BTU/h)	Input Power (kW)
1.6 + 2.0 + 3.2 + 3.2	60.8 (16)	67298.86	3.34	65914.85	3.42	58994.78	3.84	54842.75	4.10	52160.35	4.16	41430.77	4.40	40216.02	4.35	37179.16	4.21	35964.42	4.15	34564.22	4.01	32230.57	3.77
	64.4 (18)	64491.01	3.48	63060.53	3.56	55908.14	3.96	51616.70	4.20	49119.51	4.26	39130.72	4.49	38081.92	4.42	35459.93	4.24	34411.13	4.17	33884.66	4.05	33007.21	3.84
	68.0 (20)	63535.14	3.57	61859.06	3.65	53478.65	4.05	48450.40	4.29	46084.63	4.33	36621.57	4.51	35904.67	4.44	34112.43	4.27	33395.53	4.20	33283.51	4.10	33096.82	3.95
	69.8 (21)	63624.75	3.61	61739.58	3.67	52313.69	3.97	46658.15	4.15	44382.00	4.23	35277.39	4.53	34434.37	4.46	32326.82	4.29	31483.80	4.22	31999.07	4.13	32857.85	3.99
	71.6 (22)	64162.43	3.64	62396.73	3.72	53568.26	4.12	48271.18	4.37	45385.66	4.41	33843.59	4.55	33644.45	4.48	33146.61	4.31	32947.47	4.24	32757.04	4.16	32439.66	4.04
	75.2 (24)	66492.35	3.67	63797.34	3.75	50322.30	4.18	42237.28	4.44	39949.18	4.47	30796.77	4.59	31287.98	4.53	32516.00	4.36	33007.21	4.29	32312.71	4.23	31155.22	4.14
1.6 + 2.0 + 3.2 + 5.0	60.8 (16)	67298.86	3.21	65914.85	3.29	58994.78	3.69	54842.75	3.94	52160.35	3.99	41430.77	4.23	40216.02	4.17	37179.16	4.04	35964.42	3.99	34564.22	3.85	32230.57	3.62
	64.4 (18)	64491.01	3.34	63060.53	3.42	55908.14	3.80	51616.70	4.04	49119.51	4.09	39130.72	4.31	38081.92	4.24	35459.93	4.07	34411.13	4.01	33884.66	3.89	33007.21	3.69
	68.0 (20)	63535.14	3.43	61859.06	3.50	53478.65	3.89	48450.40	4.12	46084.63	4.16	36621.57	4.33	35904.67	4.26	34112.43	4.10	33395.53	4.03	33283.51	3.94	33096.82	3.79
	69.8 (21)	63624.75	3.47	61739.58	3.52	52313.69	3.81	46658.15	3.98	44382.00	4.06	35277.39	4.35	34434.37	4.28	32326.82	4.12	31483.80	4.05	31999.07	3.97	32857.85	3.83
	71.6 (22)	64162.43	3.49	62396.73	3.57	53568.26	3.96	48271.18	4.20	45385.66	4.23	33843.59	4.37	33644.45	4.30	33146.61	4.14	32947.47	4.07	32757.04	4.00	32439.66	3.88
	75.2 (24)	66492.35	3.52	63797.34	3.61	50322.30	4.01	42237.28	4.26	39949.18	4.29	30796.77	4.41	31287.98	4.35	32516.00	4.18	33007.21	4.12	32312.71	4.07	31155.22	3.97
1.6 + 2.0 + 5.0 + 5.0	60.8 (16)	68246.73	3.23	66843.23	3.31	59825.70	3.72	55615.18	3.96	52895.00	4.02	42014.30	4.26	40782.45	4.20	37702.81	4.07	36470.96	4.02	35051.04	3.88	32684.52	3.64
	64.4 (18)	65399.33	3.36	63948.71	3.44	56695.58	3.83	52343.70	4.07	49811.33	4.12	39681.85	4.34	38618.29	4.27	35959.37	4.10	34895.80	4.03	34361.91	3.92	33472.10	3.72
	68.0 (20)	64430.00	3.45	62730.31	3.53	54231.87	3.92	49132.80	4.15	46733.71	4.19	37137.37	4.36	36410.37	4.29	34592.88	4.13	33865.89	4.06	33752.29	3.97	33562.97	3.82
	69.8 (21)	64520.88	3.49	62609.15	3.55	53050.50	3.84	47315.31	4.01	45007.10	4.09	35774.25	4.38	34919.36	4.31	32782.13	4.15	31927.23	4.08	32449.76	4.00	33320.64	3.86
	71.6 (22)	65066.12	3.52	63275.56	3.60	54322.74	3.99	48951.05	4.23	46024.89	4.26	34320.26	4.40	34118.32	4.33	33613.46	4.17	33411.52	4.10	33218.41	4.03	32896.56	3.91
	75.2 (24)	67428.86	3.55	64695.90	3.63	51031.07	4.04	42832.17	4.29	40511.84	4.32	31230.53	4.44	31728.65	4.38	32973.97	4.22	33472.10	4.15	32767.82	4.09	31594.03	4.00
1.6 + 2.5 + 2.5 + 2.5	60.8 (16)	67298.86	3.40	65914.85	3.49	58994.78	3.92	54842.75	4.17	52160.35	4.24	41430.77	4.48	40216.02	4.43	37179.16	4.29	35964.42	4.23	34564.22	4.08	32230.57	3.84
	64.4 (18)	64491.01	3.54	63060.53	3.62	55908.14	4.04	51616.70	4.28	49119.51	4.34	39130.72	4.57	38081.92	4.50	35459.93	4.32	34411.13	4.25	33884.66	4.12	33007.21	3.91
	68.0 (20)	63535.14	3.64	61859.06	3.72	53478.65	4.13	48450.40	4.37	46084.63	4.41	36621.57	4.59	35904.67	4.52	34112.43	4.35	33395.53	4.28	33283.51	4.18	33096.82	4.02
	69.8 (21)	63624.75	3.68	61739.58	3.74	52313.69	4.04	46658.15	4.23	44382.00	4.30	35277.39	4.61	34434.37	4.54	32326.82	4.37	31483.80	4.30	31999.07	4.21	32857.85	4.07
	71.6 (22)	64162.43	3.70	62396.73	3.79	53568.26	4.20	48271.18	4.45	45385.66	4.49	33843.59	4.63	33644.45	4.56	33146.61	4.39	32947.47	4.32	32757.04	4.24	32439.66	4.11
	75.2 (24)	66492.35	3.74	63797.34	3.82	50322.30	4.26	42237.28	4.52	39949.18	4.55	30796.77	4.68	31287.98	4.61	32516.00	4.44	33007.21	4.37	32312.71	4.31	31155.22	4.22
1.6 + 2.5 + 2.5 + 3.2	60.8 (16)	67298.86	3.37	65914.85	3.45	58994.78	3.88	54842.75	4.14	52160.35	4.20	41430.77	4.44	40216.02	4.39	37179.16	4.25	35964.42	4.19	34564.22	4.04	32230.57	3.80
	64.4 (18)	64491.01	3.51	63060.53	3.59	55908.14	4.00	51616.70	4.24	49119.51	4.30	39130.72	4.53	38081.92	4.46	35459.93	4.28	34411.13	4.21	33884.66	4.08	33007.21	3.88
	68.0 (20)	63535.14	3.60	61859.06	3.68	53478.65	4.09	48450.40	4.33	46084.63	4.37	36621.57	4.55	35904.67	4.48	34112.43	4.31	33395.53	4.24	33283.51	4.14	33096.82	3.98
	69.8 (21)	63624.75	3.64	61739.58	3.70	52313.69	4.01	46658.15	4.19	44382.00	4.26	35277.39	4.57	34434.37	4.50	32326.82	4.33	31483.80	4.26	31999.07	4.17	32857.85	4.03
	71.6 (22)	64162.43	3.67	62396.73	3.75	53568.26	4.16	48271.18	4.41	45385.66	4.45	33843.59	4.59	33644.45	4.52	33146.61	4.35	32947.47	4.28	32757.04	4.20	32439.66	4.08
	75.2 (24)	66492.35	3.70	63797.34	3.79	50322.30	4.22	42237.28	4.48	39949.18	4.51	30796.77	4.64	31287.98	4.57	32516.00	4.40	33007.21	4.33	32312.71	4.27	31155.22	4.18
1.6 + 2.5 + 2.5 + 5.0	60.8 (16)	67298.86	3.24	65914.85	3.32	58994.78	3.73	54842.75	3.97	52160.35	4.03	41430.77	4.27	40216.02	4.21	37179.16	4.08	35964.42	4.03	34564.22	3.89	32230.57	3.65
	64.4 (18)	64491.01	3.37	63060.53	3.45	55908.14	3.84	51616.70	4.08	49119.51	4.13	39130.72	4.35	38081.92	4.28	35459.93	4.11	34411.13	4.04	33884.66	3.92	33007.21	3.72
	68.0 (20)	63535.14	3.46	61859.06	3.54	53478.65	3.93	48450.40	4.16	46084.63	4.20	36621.57	4.37	35904.67	4.30	34112.43	4.14	33395.53	4.07	33283.51	3.98	33096.82	3.83
	69.8 (21)	63624.75	3.50	61739.58	3.56	52313.69	3.85	46658.15	4.02	44382.00	4.10	35277.39	4.39	34434.37	4.32	32326.82	4.16	31483.80	4.09	31999.07	4.01	32857.85	3.87
	71.6 (22)	64162.43	3.53	62396.73	3.60	53568.26	4.00	48271.18	4.24	45385.66	4.27	33843.59	4.41	33644.45	4.34	33146.61	4.18	32947.47	4.11	32757.04	4.04	32439.66	3.92
	75.2 (24)	66492.35	3.56	63797.34	3.64	50322.30	4.05	42237.28	4.30	39949.18	4.33	30796.77	4.45	31287.98	4.39	32516.00	4.23	33007.21	4.16	32312.71	4.10	31155.22	4.01

Combination (Capacity)	Indoor Air Temp. °F (°C) DB	Outdoor Air Temp. °F (°C) WB																							
		60.8 (16)		59.0 (15)		50.0 (10)		44.6 (7)		42.8 (6)		35.6 (2)		32.0 (0)		23.0 (-5)		19.4 (-7)		14.0 (-10)		5.0 (-15)			
		Total Capacity (BTU/h)	Input Power (kW)	Total Capacity (BTU/h)	Input Power (kW)	Total Capacity (BTU/h)	Input Power (kW)	Total Capacity (BTU/h)	Input Power (kW)	Total Capacity (BTU/h)	Input Power (kW)	Total Capacity (BTU/h)	Input Power (kW)	Total Capacity (BTU/h)	Input Power (kW)	Total Capacity (BTU/h)	Input Power (kW)	Total Capacity (BTU/h)	Input Power (kW)	Total Capacity (BTU/h)	Input Power (kW)	Total Capacity (BTU/h)	Input Power (kW)		
1.6 + 2.5 + 2.5 + 7.0	60.8 (16)	68246.73	3.31	66843.23	3.40	59825.70	3.82	55615.18	4.07	52895.00	4.13	42014.30	4.37	40782.45	4.32	37702.81	4.18	36470.96	4.12	35051.04	3.98	32684.52	3.74		
	64.4 (18)	65399.33	3.45	63948.71	3.53	56695.58	3.93	52343.70	4.17	49811.33	4.23	39681.85	4.46	38618.29	4.39	35959.37	4.21	34895.80	4.14	34361.91	4.02	33472.10	3.81		
	68.0 (20)	64430.00	3.54	62730.31	3.62	54231.87	4.02	49132.80	4.26	46733.71	4.30	37137.37	4.48	36410.37	4.41	34592.88	4.24	33865.89	4.17	33752.29	4.07	33562.97	3.92		
	69.8 (21)	64520.88	3.58	62609.15	3.64	53050.50	3.94	47315.31	4.12	45007.10	4.20	35774.25	4.50	34919.36	4.43	32782.13	4.26	31927.23	4.19	32449.76	4.10	33320.64	3.96		
	71.6 (22)	65066.12	3.61	63275.56	3.69	54322.74	4.10	48951.05	4.34	46024.89	4.37	34320.26	4.52	34118.32	4.45	33613.46	4.28	33411.52	4.21	33218.41	4.13	32896.56	4.01		
	75.2 (24)	67428.86	3.64	64695.90	3.73	51031.07	4.15	42832.17	4.40	40511.84	4.44	31230.53	4.56	31728.65	4.49	32973.97	4.33	33472.10	4.26	32767.82	4.20	31594.03	4.11		
1.6 + 2.5 + 3.2 + 3.2	60.8 (16)	67298.86	3.34	65914.85	3.42	58994.78	3.84	54842.75	4.10	52160.35	4.16	41430.77	4.40	40216.02	4.35	37179.16	4.21	35964.42	4.15	34564.22	4.01	32230.57	3.77		
	64.4 (18)	64491.01	3.48	63060.53	3.56	55908.14	3.96	51616.70	4.20	49119.51	4.26	39130.72	4.49	38081.92	4.42	35459.93	4.24	34411.13	4.17	33884.66	4.05	33007.21	3.84		
	68.0 (20)	63535.14	3.57	61859.06	3.65	53478.65	4.05	48450.40	4.29	46084.63	4.33	36621.57	4.51	35904.67	4.44	34112.43	4.27	33395.53	4.20	33283.51	4.10	33096.82	3.95		
	69.8 (21)	63624.75	3.61	61739.58	3.67	52313.69	3.97	46658.15	4.15	44382.00	4.23	35277.39	4.53	34434.37	4.46	32326.82	4.29	31483.80	4.22	31999.07	4.13	32857.85	3.99		
	71.6 (22)	64162.43	3.64	62396.73	3.72	53568.26	4.12	48271.18	4.37	45385.66	4.41	33843.59	4.55	33644.45	4.48	33146.61	4.31	32947.47	4.24	32757.04	4.16	32439.66	4.04		
	75.2 (24)	66492.35	3.67	63797.34	3.75	50322.30	4.18	42237.28	4.44	39949.18	4.47	30796.77	4.59	31287.98	4.53	32516.00	4.36	33007.21	4.29	32312.71	4.23	31155.22	4.14		
1.6 + 2.5 + 3.2 + 5.0	60.8 (16)	67298.86	3.21	65914.85	3.29	58994.78	3.69	54842.75	3.94	52160.35	3.99	41430.77	4.23	40216.02	4.17	37179.16	4.04	35964.42	3.99	34564.22	3.85	32230.57	3.62		
	64.4 (18)	64491.01	3.34	63060.53	3.42	55908.14	3.80	51616.70	4.04	49119.51	4.09	39130.72	4.31	38081.92	4.24	35459.93	4.07	34411.13	4.01	33884.66	3.89	33007.21	3.69		
	68.0 (20)	63535.14	3.43	61859.06	3.50	53478.65	3.89	48450.40	4.12	46084.63	4.16	36621.57	4.33	35904.67	4.26	34112.43	4.10	33395.53	4.03	33283.51	3.94	33096.82	3.79		
	69.8 (21)	63624.75	3.47	61739.58	3.52	52313.69	3.81	46658.15	3.98	44382.00	4.06	35277.39	4.35	34434.37	4.28	32326.82	4.12	31483.80	4.05	31999.07	3.97	32857.85	3.83		
	71.6 (22)	64162.43	3.49	62396.73	3.57	53568.26	3.96	48271.18	4.20	45385.66	4.23	33843.59	4.37	33644.45	4.30	33146.61	4.14	32947.47	4.07	32757.04	4.00	32439.66	3.88		
	75.2 (24)	66492.35	3.52	63797.34	3.61	50322.30	4.01	42237.28	4.26	39949.18	4.29	30796.77	4.41	31287.98	4.35	32516.00	4.18	33007.21	4.12	32312.71	4.07	31155.22	3.97		
1.6 + 3.2 + 3.2 + 3.2	60.8 (16)	67298.86	3.31	65914.85	3.39	58994.78	3.81	54842.75	4.06	52160.35	4.12	41430.77	4.36	40216.02	4.31	37179.16	4.17	35964.42	4.11	34564.22	3.97	32230.57	3.73		
	64.4 (18)	64491.01	3.44	63060.53	3.52	55908.14	3.92	51616.70	4.16	49119.51	4.22	39130.72	4.45	38081.92	4.38	35459.93	4.20	34411.13	4.13	33884.66	4.01	33007.21	3.80		
	68.0 (20)	63535.14	3.54	61859.06	3.62	53478.65	4.01	48450.40	4.25	46084.63	4.29	36621.57	4.47	35904.67	4.40	34112.43	4.23	33395.53	4.16	33283.51	4.07	33096.82	3.91		
	69.8 (21)	63624.75	3.58	61739.58	3.63	52313.69	3.93	46658.15	4.11	44382.00	4.19	35277.39	4.49	34434.37	4.42	32326.82	4.25	31483.80	4.18	31999.07	4.09	32857.85	3.96		
	71.6 (22)	64162.43	3.60	62396.73	3.68	53568.26	4.09	48271.18	4.33	45385.66	4.36	33843.59	4.51	33644.45	4.44	33146.61	4.27	32947.47	4.20	32757.04	4.12	32439.66	4.00		
	75.2 (24)	66492.35	3.63	63797.34	3.72	50322.30	4.14	42237.28	4.39	39949.18	4.43	30796.77	4.55	31287.98	4.48	32516.00	4.32	33007.21	4.25	32312.71	4.19	31155.22	4.10		
1.6 + 3.2 + 3.2 + 5.0	60.8 (16)	68246.73	3.28	66843.23	3.36	59825.70	3.77	55615.18	4.02	52895.00	4.08	42014.30	4.32	40782.45	4.27	37702.81	4.13	36470.96	4.07	35051.04	3.93	32684.52	3.70		
	64.4 (18)	65399.33	3.41	63948.71	3.49	56695.58	3.89	52343.70	4.13	49811.33	4.18	39681.85	4.40	38618.29	4.34	35959.37	4.16	34895.80	4.09	34361.91	3.97	33472.10	3.77		
	68.0 (20)	64430.00	3.50	62730.31	3.58	54231.87	3.97	49132.80	4.21	46733.71	4.25	37137.37	4.42	36410.37	4.36	34592.88	4.19	33865.89	4.12	33752.29	4.03	33562.97	3.87		
	69.8 (21)	64520.88	3.54	62609.15	3.60	53050.50	3.90	47315.31	4.07	45007.10	4.15	35774.25	4.44	34919.36	4.38	32782.13	4.21	31927.23	4.14	32449.76	4.06	33320.64	3.92		
	71.6 (22)	65066.12	3.57	63275.56	3.65	54322.74	4.05	48951.05	4.29	46024.89	4.32	34320.26	4.46	34118.32	4.40	33613.46	4.23	33411.52	4.16	33218.41	4.09	32896.56	3.96		
	75.2 (24)	67428.86	3.60	64695.90	3.68	51031.07	4.10	42832.17	4.35	40511.84	4.38	31230.53	4.51	31728.65	4.44	32973.97	4.28	33472.10	4.21	32767.82	4.15	31594.03	4.06		
2.0 + 2.0 + 2.0 + 2.0	60.8 (16)	67298.86	3.38	65914.85	3.47	58994.78	3.90	54842.75	4.16	52160.35	4.22	41430.77	4.46	40216.02	4.41	37179.16	4.27	35964.42	4.21	34564.22	4.06	32230.57	3.82		
	64.4 (18)	64491.01	3.53	63060.53	3.61	55908.14	4.02	51616.70	4.26	49119.51	4.32	39130.72	4.55	38081.92	4.48	35459.93	4.30	34411.13	4.23	33884.66	4.10	33007.21	3.89		
	68.0 (20)	63535.14	3.62	61859.06	3.70	53478.65	4.11	48450.40	4.35	46084.63	4.39	36621.57	4.57	35904.67	4.50	34112.43	4.33	33395.53	4.26	33283.51	4.16	33096.82	4.00		
	69.8 (21)	63624.75	3.66	61739.58	3.72	52313.69	4.02	46658.15	4.21	44382.00	4.28	35277.39	4.59	34434.37	4.52	32326.82	4.35	31483.80	4.28	31999.07	4.19	32857.85	4.05		
	71.6 (22)	64162.43	3.69	62396.73	3.77	53568.26	4.18	48271.18	4.43	45385.66	4.47	33843.59	4.61	33644.45	4.54	33146.61	4.37	32947.47	4.30	32757.04	4.22	32439.66	4.10		
	75.2 (24)	66492.35	3.72	63797.34	3.81	50322.30	4.24	42237.28	4.50	39949.18	4.53	30796.77	4.66	31287.98	4.59	32516.00	4.42	33007.21	4.35	32312.71	4.29	31155.22	4.20		

Combination (Capacity)	Indoor Air Temp. °F (°C) DB	Outdoor Air Temp. °F (°C) WB																					
		60.8 (16)		59.0 (15)		50.0 (10)		44.6 (7)		42.8 (6)		35.6 (2)		32.0 (0)		23.0 (-5)		19.4 (-7)		14.0 (-10)		5.0 (-15)	
		Total Capacity (BTU/h)	Input Power (kW)	Total Capacity (BTU/h)	Input Power (kW)	Total Capacity (BTU/h)	Input Power (kW)	Total Capacity (BTU/h)	Input Power (kW)	Total Capacity (BTU/h)	Input Power (kW)	Total Capacity (BTU/h)	Input Power (kW)	Total Capacity (BTU/h)	Input Power (kW)	Total Capacity (BTU/h)	Input Power (kW)	Total Capacity (BTU/h)	Input Power (kW)	Total Capacity (BTU/h)	Input Power (kW)	Total Capacity (BTU/h)	Input Power (kW)
2.0 + 2.0 + 2.0 + 2.5	60.8 (16)	67298.86	3.38	65914.85	3.47	58994.78	3.90	54842.75	4.16	52160.35	4.22	41430.77	4.46	40216.02	4.41	37179.16	4.27	35964.42	4.21	34564.22	4.06	32230.57	3.82
	64.4 (18)	64491.01	3.53	63060.53	3.61	55908.14	4.02	51616.70	4.26	49119.51	4.32	39130.72	4.55	38081.92	4.48	35459.93	4.30	34411.13	4.23	33884.66	4.10	33007.21	3.89
	68.0 (20)	63535.14	3.62	61859.06	3.70	53478.65	4.11	48450.40	4.35	46084.63	4.39	36621.57	4.57	35904.67	4.50	34112.43	4.33	33395.53	4.26	33283.51	4.16	33096.82	4.00
	69.8 (21)	63624.75	3.66	61739.58	3.72	52313.69	4.02	46658.15	4.21	44382.00	4.28	35277.39	4.59	34434.37	4.52	32326.82	4.35	31483.80	4.28	31999.07	4.19	32857.85	4.05
	71.6 (22)	64162.43	3.69	62396.73	3.77	53568.26	4.18	48271.18	4.43	45385.66	4.47	33843.59	4.61	33644.45	4.54	33146.61	4.37	32947.47	4.30	32757.04	4.22	32439.66	4.10
	75.2 (24)	66492.35	3.72	63797.34	3.81	50322.30	4.24	42237.28	4.50	39949.18	4.53	30796.77	4.66	31287.98	4.59	32516.00	4.42	33007.21	4.35	32312.71	4.29	31155.22	4.20
2.0 + 2.0 + 2.0 + 3.2	60.8 (16)	67298.86	3.36	65914.85	3.45	58994.78	3.87	54842.75	4.13	52160.35	4.19	41430.77	4.43	40216.02	4.38	37179.16	4.24	35964.42	4.18	34564.22	4.04	32230.57	3.79
	64.4 (18)	64491.01	3.50	63060.53	3.58	55908.14	3.99	51616.70	4.23	49119.51	4.29	39130.72	4.52	38081.92	4.45	35459.93	4.27	34411.13	4.20	33884.66	4.08	33007.21	3.87
	68.0 (20)	63535.14	3.59	61859.06	3.68	53478.65	4.08	48450.40	4.32	46084.63	4.36	36621.57	4.54	35904.67	4.47	34112.43	4.30	33395.53	4.23	33283.51	4.13	33096.82	3.97
	69.8 (21)	63624.75	3.63	61739.58	3.69	52313.69	4.00	46658.15	4.18	44382.00	4.25	35277.39	4.56	34434.37	4.49	32326.82	4.32	31483.80	4.25	31999.07	4.16	32857.85	4.02
	71.6 (22)	64162.43	3.66	62396.73	3.74	53568.26	4.15	48271.18	4.40	45385.66	4.44	33843.59	4.58	33644.45	4.51	33146.61	4.34	32947.47	4.27	32757.04	4.19	32439.66	4.07
	75.2 (24)	66492.35	3.69	63797.34	3.78	50322.30	4.21	42237.28	4.47	39949.18	4.50	30796.77	4.63	31287.98	4.56	32516.00	4.39	33007.21	4.32	32312.71	4.26	31155.22	4.17
2.0 + 2.0 + 2.0 + 5.0	60.8 (16)	67298.86	3.23	65914.85	3.31	58994.78	3.72	54842.75	3.96	52160.35	4.02	41430.77	4.26	40216.02	4.20	37179.16	4.07	35964.42	4.02	34564.22	3.88	32230.57	3.64
	64.4 (18)	64491.01	3.36	63060.53	3.44	55908.14	3.83	51616.70	4.07	49119.51	4.12	39130.72	4.34	38081.92	4.27	35459.93	4.10	34411.13	4.03	33884.66	3.92	33007.21	3.72
	68.0 (20)	63535.14	3.45	61859.06	3.53	53478.65	3.92	48450.40	4.15	46084.63	4.19	36621.57	4.36	35904.67	4.29	34112.43	4.13	33395.53	4.06	33283.51	3.97	33096.82	3.82
	69.8 (21)	63624.75	3.49	61739.58	3.55	52313.69	3.84	46658.15	4.01	44382.00	4.09	35277.39	4.38	34434.37	4.31	32326.82	4.15	31483.80	4.08	31999.07	4.00	32857.85	3.86
	71.6 (22)	64162.43	3.52	62396.73	3.60	53568.26	3.99	48271.18	4.23	45385.66	4.26	33843.59	4.40	33644.45	4.33	33146.61	4.17	32947.47	4.10	32757.04	4.03	32439.66	3.91
	75.2 (24)	66492.35	3.55	63797.34	3.63	50322.30	4.04	42237.28	4.29	39949.18	4.32	30796.77	4.44	31287.98	4.38	32516.00	4.22	33007.21	4.15	32312.71	4.09	31155.22	4.00
2.0 + 2.0 + 2.0 + 7.0	60.8 (16)	68246.73	3.31	66843.23	3.39	59825.70	3.81	55615.18	4.06	52895.00	4.12	42014.30	4.36	40782.45	4.31	37702.81	4.17	36470.96	4.11	35051.04	3.97	32684.52	3.73
	64.4 (18)	65399.33	3.44	63948.71	3.52	56695.58	3.92	52343.70	4.16	49811.33	4.22	39681.85	4.45	38618.29	4.38	35959.37	4.20	34895.80	4.13	34361.91	4.01	33472.10	3.80
	68.0 (20)	64430.00	3.54	62730.31	3.62	54231.87	4.01	49132.80	4.25	46733.71	4.29	37137.37	4.47	36410.37	4.40	34592.88	4.23	33865.89	4.16	33752.29	4.07	33562.97	3.91
	69.8 (21)	64520.88	3.58	62609.15	3.63	53050.50	3.93	47315.31	4.11	45007.10	4.19	35774.25	4.49	34919.36	4.42	32782.13	4.25	31927.23	4.18	32449.76	4.09	33320.64	3.96
	71.6 (22)	65066.12	3.60	63275.56	3.68	54322.74	4.09	48951.05	4.33	46024.89	4.36	34320.26	4.51	34118.32	4.44	33613.46	4.27	33411.52	4.20	33218.41	4.12	32896.56	4.00
	75.2 (24)	67428.86	3.63	64695.90	3.72	51031.07	4.14	42832.17	4.39	40511.84	4.43	31230.53	4.55	31728.65	4.48	32973.97	4.32	33472.10	4.25	32767.82	4.19	31594.03	4.10
2.0 + 2.0 + 2.5 + 2.5	60.8 (16)	67298.86	3.38	65914.85	3.47	58994.78	3.90	54842.75	4.16	52160.35	4.22	41430.77	4.46	40216.02	4.41	37179.16	4.27	35964.42	4.21	34564.22	4.06	32230.57	3.82
	64.4 (18)	64491.01	3.53	63060.53	3.61	55908.14	4.02	51616.70	4.26	49119.51	4.32	39130.72	4.55	38081.92	4.48	35459.93	4.30	34411.13	4.23	33884.66	4.10	33007.21	3.89
	68.0 (20)	63535.14	3.62	61859.06	3.70	53478.65	4.11	48450.40	4.35	46084.63	4.39	36621.57	4.57	35904.67	4.50	34112.43	4.33	33395.53	4.26	33283.51	4.16	33096.82	4.00
	69.8 (21)	63624.75	3.66	61739.58	3.72	52313.69	4.02	46658.15	4.21	44382.00	4.28	35277.39	4.59	34434.37	4.52	32326.82	4.35	31483.80	4.28	31999.07	4.19	32857.85	4.05
	71.6 (22)	64162.43	3.69	62396.73	3.77	53568.26	4.18	48271.18	4.43	45385.66	4.47	33843.59	4.61	33644.45	4.54	33146.61	4.37	32947.47	4.30	32757.04	4.22	32439.66	4.10
	75.2 (24)	66492.35	3.72	63797.34	3.81	50322.30	4.24	42237.28	4.50	39949.18	4.53	30796.77	4.66	31287.98	4.59	32516.00	4.42	33007.21	4.35	32312.71	4.29	31155.22	4.20
2.0 + 2.0 + 2.5 + 3.2	60.8 (16)	67298.86	3.36	65914.85	3.45	58994.78	3.87	54842.75	4.13	52160.35	4.19	41430.77	4.43	40216.02	4.38	37179.16	4.24	35964.42	4.18	34564.22	4.04	32230.57	3.79
	64.4 (18)	64491.01	3.50	63060.53	3.58	55908.14	3.99	51616.70	4.23	49119.51	4.29	39130.72	4.52	38081.92	4.45	35459.93	4.27	34411.13	4.20	33884.66	4.08	33007.21	3.87
	68.0 (20)	63535.14	3.59	61859.06	3.68	53478.65	4.08	48450.40	4.32	46084.63	4.36	36621.57	4.54	35904.67	4.47	34112.43	4.30	33395.53	4.23	33283.51	4.13	33096.82	3.97
	69.8 (21)	63624.75	3.63	61739.58	3.69	52313.69	4.00	46658.15	4.18	44382.00	4.25	35277.39	4.56	34434.37	4.49	32326.82	4.32	31483.80	4.25	31999.07	4.16	32857.85	4.02
	71.6 (22)	64162.43	3.66	62396.73	3.74	53568.26	4.15	48271.18	4.40	45385.66	4.44	33843.59	4.58	33644.45	4.51	33146.61	4.34	32947.47	4.27	32757.04	4.19	32439.66	4.07
	75.2 (24)	66492.35	3.69	63797.34	3.78	50322.30	4.21	42237.28	4.47	39949.18	4.50	30796.77	4.63	31287.98	4.56	32516.00	4.39	33007.21	4.32	32312.71	4.26	31155.22	4.17

Combination (Capacity)	Indoor Air Temp. °F (°C) DB	Outdoor Air Temp. °F (°C) WB																					
		60.8 (16)		59.0 (15)		50.0 (10)		44.6 (7)		42.8 (6)		35.6 (2)		32.0 (0)		23.0 (-5)		19.4 (-7)		14.0 (-10)		5.0 (-15)	
		Total Capacity (BTU/h)	Input Power (kW)	Total Capacity (BTU/h)	Input Power (kW)	Total Capacity (BTU/h)	Input Power (kW)	Total Capacity (BTU/h)	Input Power (kW)	Total Capacity (BTU/h)	Input Power (kW)	Total Capacity (BTU/h)	Input Power (kW)	Total Capacity (BTU/h)	Input Power (kW)	Total Capacity (BTU/h)	Input Power (kW)	Total Capacity (BTU/h)	Input Power (kW)	Total Capacity (BTU/h)	Input Power (kW)	Total Capacity (BTU/h)	Input Power (kW)
2.0 + 2.0 + 2.5 + 5.0	60.8 (16)	67298.86	3.23	65914.85	3.31	58994.78	3.72	54842.75	3.96	52160.35	4.02	41430.77	4.26	40216.02	4.20	37179.16	4.07	35964.42	4.02	34564.22	3.88	32230.57	3.64
	64.4 (18)	64491.01	3.36	63060.53	3.44	55908.14	3.83	51616.70	4.07	49119.51	4.12	39130.72	4.34	38081.92	4.27	35459.93	4.10	34411.13	4.03	33884.66	3.92	33007.21	3.72
	68.0 (20)	63535.14	3.45	61859.06	3.53	53478.65	3.92	48450.40	4.15	46084.63	4.19	36621.57	4.36	35904.67	4.29	34112.43	4.13	33395.53	4.06	33283.51	3.97	33096.82	3.82
	69.8 (21)	63624.75	3.49	61739.58	3.55	52313.69	3.84	46658.15	4.01	44382.00	4.09	35277.39	4.38	34434.37	4.31	32326.82	4.15	31483.80	4.08	31999.07	4.00	32857.85	3.86
	71.6 (22)	64162.43	3.52	62396.73	3.60	53568.26	3.99	48271.18	4.23	45385.66	4.26	33843.59	4.40	33644.45	4.33	33146.61	4.17	32947.47	4.10	32757.04	4.03	32439.66	3.91
	75.2 (24)	66492.35	3.55	63797.34	3.63	50322.30	4.04	42237.28	4.29	39949.18	4.32	30796.77	4.44	31287.98	4.38	32516.00	4.22	33007.21	4.15	32312.71	4.09	31155.22	4.00
2.0 + 2.0 + 2.5 + 7.0	60.8 (16)	68246.73	3.31	66843.23	3.39	59825.70	3.81	55615.18	4.06	52895.00	4.12	42014.30	4.36	40782.45	4.31	37702.81	4.17	36470.96	4.11	35051.04	3.97	32684.52	3.73
	64.4 (18)	65399.33	3.44	63948.71	3.52	56695.58	3.92	52343.70	4.16	49811.33	4.22	39681.85	4.45	38618.29	4.38	35959.37	4.20	34895.80	4.13	34361.91	4.01	33472.10	3.80
	68.0 (20)	64430.00	3.54	62730.31	3.62	54231.87	4.01	49132.80	4.25	46733.71	4.29	37137.37	4.47	36410.37	4.40	34592.88	4.23	33865.89	4.16	33752.29	4.07	33562.97	3.91
	69.8 (21)	64520.88	3.58	62609.15	3.63	53050.50	3.93	47315.31	4.11	45007.10	4.19	35774.25	4.49	34919.36	4.42	32782.13	4.25	31927.23	4.18	32449.76	4.09	33320.64	3.96
	71.6 (22)	65066.12	3.60	63275.56	3.68	54322.74	4.09	48951.05	4.33	46024.89	4.36	34320.26	4.51	34118.32	4.44	33613.46	4.27	33411.52	4.20	33218.41	4.12	32896.56	4.00
	75.2 (24)	67428.86	3.63	64695.90	3.72	51031.07	4.14	42832.17	4.39	40511.84	4.43	31230.53	4.55	31728.65	4.48	32973.97	4.32	33472.10	4.25	32767.82	4.19	31594.03	4.10
2.0 + 2.0 + 3.2 + 3.2	60.8 (16)	67298.86	3.33	65914.85	3.41	58994.78	3.84	54842.75	4.09	52160.35	4.15	41430.77	4.39	40216.02	4.34	37179.16	4.20	35964.42	4.14	34564.22	4.00	32230.57	3.76
	64.4 (18)	64491.01	3.47	63060.53	3.55	55908.14	3.95	51616.70	4.19	49119.51	4.25	39130.72	4.48	38081.92	4.41	35459.93	4.23	34411.13	4.16	33884.66	4.04	33007.21	3.83
	68.0 (20)	63535.14	3.56	61859.06	3.64	53478.65	4.04	48450.40	4.28	46084.63	4.32	36621.57	4.50	35904.67	4.43	34112.43	4.26	33395.53	4.19	33283.51	4.09	33096.82	3.94
	69.8 (21)	63624.75	3.60	61739.58	3.66	52313.69	3.96	46658.15	4.14	44382.00	4.22	35277.39	4.52	34434.37	4.45	32326.82	4.28	31483.80	4.21	31999.07	4.12	32857.85	3.98
	71.6 (22)	64162.43	3.63	62396.73	3.71	53568.26	4.12	48271.18	4.36	45385.66	4.39	33843.59	4.54	33644.45	4.47	33146.61	4.30	32947.47	4.23	32757.04	4.15	32439.66	4.03
	75.2 (24)	66492.35	3.66	63797.34	3.75	50322.30	4.17	42237.28	4.43	39949.18	4.46	30796.77	4.58	31287.98	4.52	32516.00	4.35	33007.21	4.28	32312.71	4.22	31155.22	4.13
2.0 + 2.0 + 3.2 + 5.0	60.8 (16)	67298.86	3.20	65914.85	3.28	58994.78	3.68	54842.75	3.93	52160.35	3.98	41430.77	4.22	40216.02	4.16	37179.16	4.03	35964.42	3.98	34564.22	3.84	32230.57	3.61
	64.4 (18)	64491.01	3.33	63060.53	3.41	55908.14	3.80	51616.70	4.03	49119.51	4.08	39130.72	4.30	38081.92	4.23	35459.93	4.06	34411.13	4.00	33884.66	3.88	33007.21	3.68
	68.0 (20)	63535.14	3.42	61859.06	3.50	53478.65	3.88	48450.40	4.11	46084.63	4.15	36621.57	4.32	35904.67	4.25	34112.43	4.09	33395.53	4.02	33283.51	3.93	33096.82	3.78
	69.8 (21)	63624.75	3.46	61739.58	3.52	52313.69	3.80	46658.15	3.98	44382.00	4.05	35277.39	4.34	34434.37	4.27	32326.82	4.11	31483.80	4.04	31999.07	3.96	32857.85	3.83
	71.6 (22)	64162.43	3.48	62396.73	3.56	53568.26	3.95	48271.18	4.19	45385.66	4.22	33843.59	4.36	33644.45	4.29	33146.61	4.13	32947.47	4.06	32757.04	3.99	32439.66	3.87
	75.2 (24)	66492.35	3.51	63797.34	3.60	50322.30	4.00	42237.28	4.25	39949.18	4.28	30796.77	4.40	31287.98	4.34	32516.00	4.17	33007.21	4.11	32312.71	4.06	31155.22	3.96
2.0 + 2.5 + 2.5 + 2.5	60.8 (16)	67298.86	3.38	65914.85	3.47	58994.78	3.90	54842.75	4.16	52160.35	4.22	41430.77	4.46	40216.02	4.41	37179.16	4.27	35964.42	4.21	34564.22	4.06	32230.57	3.82
	64.4 (18)	64491.01	3.53	63060.53	3.61	55908.14	4.02	51616.70	4.26	49119.51	4.32	39130.72	4.55	38081.92	4.48	35459.93	4.30	34411.13	4.23	33884.66	4.10	33007.21	3.89
	68.0 (20)	63535.14	3.62	61859.06	3.70	53478.65	4.11	48450.40	4.35	46084.63	4.39	36621.57	4.57	35904.67	4.50	34112.43	4.33	33395.53	4.26	33283.51	4.16	33096.82	4.00
	69.8 (21)	63624.75	3.66	61739.58	3.72	52313.69	4.02	46658.15	4.21	44382.00	4.28	35277.39	4.59	34434.37	4.52	32326.82	4.35	31483.80	4.28	31999.07	4.19	32857.85	4.05
	71.6 (22)	64162.43	3.69	62396.73	3.77	53568.26	4.18	48271.18	4.43	45385.66	4.47	33843.59	4.61	33644.45	4.54	33146.61	4.37	32947.47	4.30	32757.04	4.22	32439.66	4.10
	75.2 (24)	66492.35	3.72	63797.34	3.81	50322.30	4.24	42237.28	4.50	39949.18	4.53	30796.77	4.66	31287.98	4.59	32516.00	4.42	33007.21	4.35	32312.71	4.29	31155.22	4.20
2.0 + 2.5 + 2.5 + 3.2	60.8 (16)	67298.86	3.36	65914.85	3.45	58994.78	3.87	54842.75	4.13	52160.35	4.19	41430.77	4.43	40216.02	4.38	37179.16	4.24	35964.42	4.18	34564.22	4.04	32230.57	3.79
	64.4 (18)	64491.01	3.50	63060.53	3.58	55908.14	3.99	51616.70	4.23	49119.51	4.29	39130.72	4.52	38081.92	4.45	35459.93	4.27	34411.13	4.20	33884.66	4.08	33007.21	3.87
	68.0 (20)	63535.14	3.59	61859.06	3.68	53478.65	4.08	48450.40	4.32	46084.63	4.36	36621.57	4.54	35904.67	4.47	34112.43	4.30	33395.53	4.23	33283.51	4.13	33096.82	3.97
	69.8 (21)	63624.75	3.63	61739.58	3.69	52313.69	4.00	46658.15	4.18	44382.00	4.25	35277.39	4.56	34434.37	4.49	32326.82	4.32	31483.80	4.25	31999.07	4.16	32857.85	4.02
	71.6 (22)	64162.43	3.66	62396.73	3.74	53568.26	4.15	48271.18	4.40	45385.66	4.44	33843.59	4.58	33644.45	4.51	33146.61	4.34	32947.47	4.27	32757.04	4.19	32439.66	4.07
	75.2 (24)	66492.35	3.69	63797.34	3.78	50322.30	4.21	42237.28	4.47	39949.18	4.50	30796.77	4.63	31287.98	4.56	32516.00	4.39	33007.21	4.32	32312.71	4.26	31155.22	4.17

Combination (Capacity)	Indoor Air Temp. °F (°C) DB	Outdoor Air Temp. °F (°C) WB																					
		60.8 (16)		59.0 (15)		50.0 (10)		44.6 (7)		42.8 (6)		35.6 (2)		32.0 (0)		23.0 (-5)		19.4 (-7)		14.0 (-10)		5.0 (-15)	
		Total Capacity (BTU/h)	Input Power (kW)	Total Capacity (BTU/h)	Input Power (kW)	Total Capacity (BTU/h)	Input Power (kW)	Total Capacity (BTU/h)	Input Power (kW)	Total Capacity (BTU/h)	Input Power (kW)	Total Capacity (BTU/h)	Input Power (kW)	Total Capacity (BTU/h)	Input Power (kW)	Total Capacity (BTU/h)	Input Power (kW)	Total Capacity (BTU/h)	Input Power (kW)	Total Capacity (BTU/h)	Input Power (kW)	Total Capacity (BTU/h)	Input Power (kW)
2.0 + 2.5 + 2.5 + 5.0	60.8 (16)	67298.86	3.23	65914.85	3.31	58994.78	3.72	54842.75	3.96	52160.35	4.02	41430.77	4.26	40216.02	4.20	37179.16	4.07	35964.42	4.02	34564.22	3.88	32230.57	3.64
	64.4 (18)	64491.01	3.36	63060.53	3.44	55908.14	3.83	51616.70	4.07	49119.51	4.12	39130.72	4.34	38081.92	4.27	35459.93	4.10	34411.13	4.03	33884.66	3.92	33007.21	3.72
	68.0 (20)	63535.14	3.45	61859.06	3.53	53478.65	3.92	48450.40	4.15	46084.63	4.19	36621.57	4.36	35904.67	4.29	34112.43	4.13	33395.53	4.06	33283.51	3.97	33096.82	3.82
	69.8 (21)	63624.75	3.49	61739.58	3.55	52313.69	3.84	46658.15	4.01	44382.00	4.09	35277.39	4.38	34434.37	4.31	32326.82	4.15	31483.80	4.08	31999.07	4.00	32857.85	3.86
	71.6 (22)	64162.43	3.52	62396.73	3.60	53568.26	3.99	48271.18	4.23	45385.66	4.26	33843.59	4.40	33644.45	4.33	33146.61	4.17	32947.47	4.10	32757.04	4.03	32439.66	3.91
	75.2 (24)	66492.35	3.55	63797.34	3.63	50322.30	4.04	42237.28	4.29	39949.18	4.32	30796.77	4.44	31287.98	4.38	32516.00	4.22	33007.21	4.15	32312.71	4.09	31155.22	4.00
2.0 + 2.5 + 3.2 + 3.2	60.8 (16)	67298.86	3.33	65914.85	3.41	58994.78	3.84	54842.75	4.09	52160.35	4.15	41430.77	4.39	40216.02	4.34	37179.16	4.20	35964.42	4.14	34564.22	4.00	32230.57	3.76
	64.4 (18)	64491.01	3.47	63060.53	3.55	55908.14	3.95	51616.70	4.19	49119.51	4.25	39130.72	4.48	38081.92	4.41	35459.93	4.23	34411.13	4.16	33884.66	4.04	33007.21	3.83
	68.0 (20)	63535.14	3.56	61859.06	3.64	53478.65	4.04	48450.40	4.28	46084.63	4.32	36621.57	4.50	35904.67	4.43	34112.43	4.26	33395.53	4.19	33283.51	4.09	33096.82	3.94
	69.8 (21)	63624.75	3.60	61739.58	3.66	52313.69	3.96	46658.15	4.14	44382.00	4.22	35277.39	4.52	34434.37	4.45	32326.82	4.28	31483.80	4.21	31999.07	4.12	32857.85	3.98
	71.6 (22)	64162.43	3.63	62396.73	3.71	53568.26	4.12	48271.18	4.36	45385.66	4.39	33843.59	4.54	33644.45	4.47	33146.61	4.30	32947.47	4.23	32757.04	4.15	32439.66	4.03
	75.2 (24)	66492.35	3.66	63797.34	3.75	50322.30	4.17	42237.28	4.43	39949.18	4.46	30796.77	4.58	31287.98	4.52	32516.00	4.35	33007.21	4.28	32312.71	4.22	31155.22	4.13
2.0 + 2.5 + 3.2 + 5.0	60.8 (16)	67298.86	3.20	65914.85	3.28	58994.78	3.68	54842.75	3.93	52160.35	3.98	41430.77	4.22	40216.02	4.16	37179.16	4.03	35964.42	3.98	34564.22	3.84	32230.57	3.61
	64.4 (18)	64491.01	3.33	63060.53	3.41	55908.14	3.80	51616.70	4.03	49119.51	4.08	39130.72	4.30	38081.92	4.23	35459.93	4.06	34411.13	4.00	33884.66	3.88	33007.21	3.68
	68.0 (20)	63535.14	3.42	61859.06	3.50	53478.65	3.88	48450.40	4.11	46084.63	4.15	36621.57	4.32	35904.67	4.25	34112.43	4.09	33395.53	4.02	33283.51	3.93	33096.82	3.78
	69.8 (21)	63624.75	3.46	61739.58	3.52	52313.69	3.80	46658.15	3.98	44382.00	4.05	35277.39	4.34	34434.37	4.27	32326.82	4.11	31483.80	4.04	31999.07	3.96	32857.85	3.83
	71.6 (22)	64162.43	3.48	62396.73	3.56	53568.26	3.95	48271.18	4.19	45385.66	4.22	33843.59	4.36	33644.45	4.29	33146.61	4.13	32947.47	4.06	32757.04	3.99	32439.66	3.87
	75.2 (24)	66492.35	3.51	63797.34	3.60	50322.30	4.00	42237.28	4.25	39949.18	4.28	30796.77	4.40	31287.98	4.34	32516.00	4.17	33007.21	4.11	32312.71	4.06	31155.22	3.96
2.0 + 3.2 + 3.2 + 3.2	60.8 (16)	67298.86	3.30	65914.85	3.38	58994.78	3.80	54842.75	4.05	52160.35	4.11	41430.77	4.35	40216.02	4.30	37179.16	4.16	35964.42	4.10	34564.22	3.96	32230.57	3.72
	64.4 (18)	64491.01	3.44	63060.53	3.52	55908.14	3.92	51616.70	4.16	49119.51	4.21	39130.72	4.44	38081.92	4.37	35459.93	4.19	34411.13	4.12	33884.66	4.00	33007.21	3.80
	68.0 (20)	63535.14	3.53	61859.06	3.61	53478.65	4.00	48450.40	4.24	46084.63	4.28	36621.57	4.46	35904.67	4.39	34112.43	4.22	33395.53	4.15	33283.51	4.06	33096.82	3.90
	69.8 (21)	63624.75	3.57	61739.58	3.63	52313.69	3.92	46658.15	4.10	44382.00	4.18	35277.39	4.48	34434.37	4.41	32326.82	4.24	31483.80	4.17	31999.07	4.08	32857.85	3.95
	71.6 (22)	64162.43	3.59	62396.73	3.67	53568.26	4.08	48271.18	4.32	45385.66	4.35	33843.59	4.49	33644.45	4.43	33146.61	4.26	32947.47	4.19	32757.04	4.11	32439.66	3.99
	75.2 (24)	66492.35	3.63	63797.34	3.71	50322.30	4.13	42237.28	4.38	39949.18	4.42	30796.77	4.54	31287.98	4.47	32516.00	4.31	33007.21	4.24	32312.71	4.18	31155.22	4.09
2.0 + 3.2 + 3.2 + 5.0	60.8 (16)	68246.73	3.27	66843.23	3.35	59825.70	3.76	55615.18	4.01	52895.00	4.07	42014.30	4.31	40782.45	4.26	37702.81	4.12	36470.96	4.06	35051.04	3.92	32684.52	3.69
	64.4 (18)	65399.33	3.40	63948.71	3.48	56695.58	3.88	52343.70	4.12	49811.33	4.17	39681.85	4.39	38618.29	4.33	35959.37	4.15	34895.80	4.08	34361.91	3.96	33472.10	3.76
	68.0 (20)	64430.00	3.49	62730.31	3.57	54231.87	3.96	49132.80	4.20	46733.71	4.24	37137.37	4.41	36410.37	4.35	34592.88	4.18	33865.89	4.11	33752.29	4.02	33562.97	3.86
	69.8 (21)	64520.88	3.53	62609.15	3.59	53050.50	3.89	47315.31	4.06	45007.10	4.14	35774.25	4.43	34919.36	4.37	32782.13	4.20	31927.23	4.13	32449.76	4.05	33320.64	3.91
	71.6 (22)	65066.12	3.56	63275.56	3.64	54322.74	4.04	48951.05	4.28	46024.89	4.31	34320.26	4.45	34118.32	4.38	33613.46	4.22	33411.52	4.15	33218.41	4.08	32896.56	3.95
	75.2 (24)	67428.86	3.59	64695.90	3.68	51031.07	4.09	42832.17	4.34	40511.84	4.37	31230.53	4.50	31728.65	4.43	32973.97	4.27	33472.10	4.20	32767.82	4.14	31594.03	4.05
2.5 + 2.5 + 2.5 + 5.0	60.8 (16)	67298.86	3.38	65914.85	3.47	58994.78	3.90	54842.75	4.16	52160.35	4.22	41430.77	4.46	40216.02	4.41	37179.16	4.27	35964.42	4.21	34564.22	4.06	32230.57	3.82
	64.4 (18)	64491.01	3.53	63060.53	3.61	55908.14	4.02	51616.70	4.26	49119.51	4.32	39130.72	4.55	38081.92	4.48	35459.93	4.30	34411.13	4.23	33884.66	4.10	33007.21	3.89
	68.0 (20)	63535.14	3.62	61859.06	3.70	53478.65	4.11	48450.40	4.35	46084.63	4.39	36621.57	4.57	35904.67	4.50	34112.43	4.33	33395.53	4.26	33283.51	4.16	33096.82	4.00
	69.8 (21)	63624.75	3.66	61739.58	3.72	52313.69	4.02	46658.15	4.21	44382.00	4.28	35277.39	4.59	34434.37	4.52	32326.82	4.35	31483.80	4.28	31999.07	4.19	32857.85	4.05
	71.6 (22)	64162.43	3.69	62396.73	3.77	53568.26	4.18	48271.18	4.43	45385.66	4.47	33843.59	4.61	33644.45	4.54	33146.61	4.37	32947.47	4.30	32757.04	4.22	32439.66	4.10
	75.2 (24)	66492.35	3.72	63797.34	3.81	50322.30	4.24	42237.28	4.50	39949.18	4.53	30796.77	4.66	31287.98	4.59	32516.00	4.42	33007.21	4.35	32312.71	4.29	31155.22	4.20

Combination (Capacity)	Indoor Air Temp. °F (°C) DB	Outdoor Air Temp. °F (°C) WB																					
		60.8 (16)		59.0 (15)		50.0 (10)		44.6 (7)		42.8 (6)		35.6 (2)		32.0 (0)		23.0 (-5)		19.4 (-7)		14.0 (-10)		5.0 (-15)	
		Total Capacity (BTU/h)	Input Power (kW)	Total Capacity (BTU/h)	Input Power (kW)	Total Capacity (BTU/h)	Input Power (kW)	Total Capacity (BTU/h)	Input Power (kW)	Total Capacity (BTU/h)	Input Power (kW)	Total Capacity (BTU/h)	Input Power (kW)	Total Capacity (BTU/h)	Input Power (kW)	Total Capacity (BTU/h)	Input Power (kW)	Total Capacity (BTU/h)	Input Power (kW)	Total Capacity (BTU/h)	Input Power (kW)	Total Capacity (BTU/h)	Input Power (kW)
2.5 + 2.5 + 2.5 + 3.2	60.8 (16)	67298.86	3.36	65914.85	3.45	58994.78	3.87	54842.75	4.13	52160.35	4.19	41430.77	4.43	40216.02	4.38	37179.16	4.24	35964.42	4.18	34564.22	4.04	32230.57	3.79
	64.4 (18)	64491.01	3.50	63060.53	3.58	55908.14	3.99	51616.70	4.23	49119.51	4.29	39130.72	4.52	38081.92	4.45	35459.93	4.27	34411.13	4.20	33884.66	4.08	33007.21	3.87
	68.0 (20)	63535.14	3.59	61859.06	3.68	53478.65	4.08	48450.40	4.32	46084.63	4.36	36621.57	4.54	35904.67	4.47	34112.43	4.30	33395.53	4.23	33283.51	4.13	33096.82	3.97
	69.8 (21)	63624.75	3.63	61739.58	3.69	52313.69	4.00	46658.15	4.18	44382.00	4.25	35277.39	4.56	34434.37	4.49	32326.82	4.32	31483.80	4.25	31999.07	4.16	32857.85	4.02
	71.6 (22)	64162.43	3.66	62396.73	3.74	53568.26	4.15	48271.18	4.40	45385.66	4.44	33843.59	4.58	33644.45	4.51	33146.61	4.34	32947.47	4.27	32757.04	4.19	32439.66	4.07
	75.2 (24)	66492.35	3.69	63797.34	3.78	50322.30	4.21	42237.28	4.47	39949.18	4.50	30796.77	4.63	31287.98	4.56	32516.00	4.39	33007.21	4.32	32312.71	4.26	31155.22	4.17
2.5 + 2.5 + 2.5 + 5.0	60.8 (16)	67298.86	3.23	65914.85	3.31	58994.78	3.72	54842.75	3.96	52160.35	4.02	41430.77	4.26	40216.02	4.20	37179.16	4.07	35964.42	4.02	34564.22	3.88	32230.57	3.64
	64.4 (18)	64491.01	3.36	63060.53	3.44	55908.14	3.83	51616.70	4.07	49119.51	4.12	39130.72	4.34	38081.92	4.27	35459.93	4.10	34411.13	4.03	33884.66	3.92	33007.21	3.72
	68.0 (20)	63535.14	3.45	61859.06	3.53	53478.65	3.92	48450.40	4.15	46084.63	4.19	36621.57	4.36	35904.67	4.29	34112.43	4.13	33395.53	4.06	33283.51	3.97	33096.82	3.82
	69.8 (21)	63624.75	3.49	61739.58	3.55	52313.69	3.84	46658.15	4.01	44382.00	4.09	35277.39	4.38	34434.37	4.31	32326.82	4.15	31483.80	4.08	31999.07	4.00	32857.85	3.86
	71.6 (22)	64162.43	3.52	62396.73	3.60	53568.26	3.99	48271.18	4.23	45385.66	4.26	33843.59	4.40	33644.45	4.33	33146.61	4.17	32947.47	4.10	32757.04	4.03	32439.66	3.91
	75.2 (24)	66492.35	3.55	63797.34	3.63	50322.30	4.04	42237.28	4.29	39949.18	4.32	30796.77	4.44	31287.98	4.38	32516.00	4.22	33007.21	4.15	32312.71	4.09	31155.22	4.00
2.5 + 2.5 + 3.2 + 3.2	60.8 (16)	67298.86	3.33	65914.85	3.41	58994.78	3.84	54842.75	4.09	52160.35	4.15	41430.77	4.39	40216.02	4.34	37179.16	4.20	35964.42	4.14	34564.22	4.00	32230.57	3.76
	64.4 (18)	64491.01	3.47	63060.53	3.55	55908.14	3.95	51616.70	4.19	49119.51	4.25	39130.72	4.48	38081.92	4.41	35459.93	4.23	34411.13	4.16	33884.66	4.04	33007.21	3.83
	68.0 (20)	63535.14	3.56	61859.06	3.64	53478.65	4.04	48450.40	4.28	46084.63	4.32	36621.57	4.50	35904.67	4.43	34112.43	4.26	33395.53	4.19	33283.51	4.09	33096.82	3.94
	69.8 (21)	63624.75	3.60	61739.58	3.66	52313.69	3.96	46658.15	4.14	44382.00	4.22	35277.39	4.52	34434.37	4.45	32326.82	4.28	31483.80	4.21	31999.07	4.12	32857.85	3.98
	71.6 (22)	64162.43	3.63	62396.73	3.71	53568.26	4.12	48271.18	4.36	45385.66	4.39	33843.59	4.54	33644.45	4.47	33146.61	4.30	32947.47	4.23	32757.04	4.15	32439.66	4.03
	75.2 (24)	66492.35	3.66	63797.34	3.75	50322.30	4.17	42237.28	4.43	39949.18	4.46	30796.77	4.58	31287.98	4.52	32516.00	4.35	33007.21	4.28	32312.71	4.22	31155.22	4.13
2.5 + 2.5 + 3.2 + 5.0	60.8 (16)	68246.73	3.29	66843.23	3.37	59825.70	3.79	55615.18	4.04	52895.00	4.10	42014.30	4.34	40782.45	4.29	37702.81	4.15	36470.96	4.09	35051.04	3.95	32684.52	3.72
	64.4 (18)	65399.33	3.43	63948.71	3.51	56695.58	3.91	52343.70	4.15	49811.33	4.20	39681.85	4.43	38618.29	4.36	35959.37	4.18	34895.80	4.11	34361.91	3.99	33472.10	3.79
	68.0 (20)	64430.00	3.52	62730.31	3.60	54231.87	3.99	49132.80	4.23	46733.71	4.27	37137.37	4.45	36410.37	4.38	34592.88	4.21	33865.89	4.14	33752.29	4.05	33562.97	3.89
	69.8 (21)	64520.88	3.56	62609.15	3.62	53050.50	3.91	47315.31	4.09	45007.10	4.17	35774.25	4.46	34919.36	4.40	32782.13	4.23	31927.23	4.16	32449.76	4.08	33320.64	3.94
	71.6 (22)	65066.12	3.58	63275.56	3.67	54322.74	4.07	48951.05	4.31	46024.89	4.34	34320.26	4.48	34118.32	4.42	33613.46	4.25	33411.52	4.18	33218.41	4.10	32896.56	3.98
	75.2 (24)	67428.86	3.62	64695.90	3.70	51031.07	4.12	42832.17	4.37	40511.84	4.40	31230.53	4.53	31728.65	4.46	32973.97	4.30	33472.10	4.23	32767.82	4.17	31594.03	4.08
2.5 + 3.2 + 3.2 + 3.2	60.8 (16)	67298.86	3.30	65914.85	3.38	58994.78	3.80	54842.75	4.05	52160.35	4.11	41430.77	4.35	40216.02	4.30	37179.16	4.16	35964.42	4.10	34564.22	3.96	32230.57	3.72
	64.4 (18)	64491.01	3.44	63060.53	3.52	55908.14	3.92	51616.70	4.16	49119.51	4.21	39130.72	4.44	38081.92	4.37	35459.93	4.19	34411.13	4.12	33884.66	4.00	33007.21	3.80
	68.0 (20)	63535.14	3.53	61859.06	3.61	53478.65	4.00	48450.40	4.24	46084.63	4.28	36621.57	4.46	35904.67	4.39	34112.43	4.22	33395.53	4.15	33283.51	4.06	33096.82	3.90
	69.8 (21)	63624.75	3.57	61739.58	3.63	52313.69	3.92	46658.15	4.10	44382.00	4.18	35277.39	4.48	34434.37	4.41	32326.82	4.24	31483.80	4.17	31999.07	4.08	32857.85	3.95
	71.6 (22)	64162.43	3.59	62396.73	3.67	53568.26	4.08	48271.18	4.32	45385.66	4.35	33843.59	4.49	33644.45	4.43	33146.61	4.26	32947.47	4.19	32757.04	4.11	32439.66	3.99
	75.2 (24)	66492.35	3.63	63797.34	3.71	50322.30	4.13	42237.28	4.38	39949.18	4.42	30796.77	4.54	31287.98	4.47	32516.00	4.31	33007.21	4.24	32312.71	4.18	31155.22	4.09
3.2 + 3.2 + 3.2 + 3.2	60.8 (16)	68246.73	3.37	66843.23	3.45	59825.70	3.88	55615.18	4.14	52895.00	4.20	42014.30	4.44	40782.45	4.39	37702.81	4.25	36470.96	4.19	35051.04	4.04	32684.52	3.80
	64.4 (18)	65399.33	3.51	63948.71	3.59	56695.58	4.00	52343.70	4.24	49811.33	4.30	39681.85	4.53	38618.29	4.46	35959.37	4.28	34895.80	4.21	34361.91	4.08	33472.10	3.88
	68.0 (20)	64430.00	3.60	62730.31	3.68	54231.87	4.09	49132.80	4.33	46733.71	4.37	37137.37	4.55	36410.37	4.48	34592.88	4.31	33865.89	4.24	33752.29	4.14	33562.97	3.98
	69.8 (21)	64520.88	3.64	62609.15	3.70	53050.50	4.01	47315.31	4.19	45007.10	4.26	35774.25	4.57	34919.36	4.50	32782.13	4.33	31927.23	4.26	32449.76	4.17	33320.64	4.03
	71.6 (22)	65066.12	3.67	63275.56	3.75	54322.74	4.16	48951.05	4.41	46024.89	4.45	34320.26	4.59	34118.32	4.52	33613.46	4.35	33411.52	4.28	33218.41	4.20	32896.56	4.08
	75.2 (24)	67428.86	3.70	64695.90	3.79	51031.07	4.22	42832.17	4.48	40511.84	4.51	31230.53	4.64	31728.65	4.57	32973.97	4.40	33472.10	4.33	32767.82	4.27	31594.03	4.18

18. Exploded View and Replacement Parts List

18.1 CU-3E19RBU

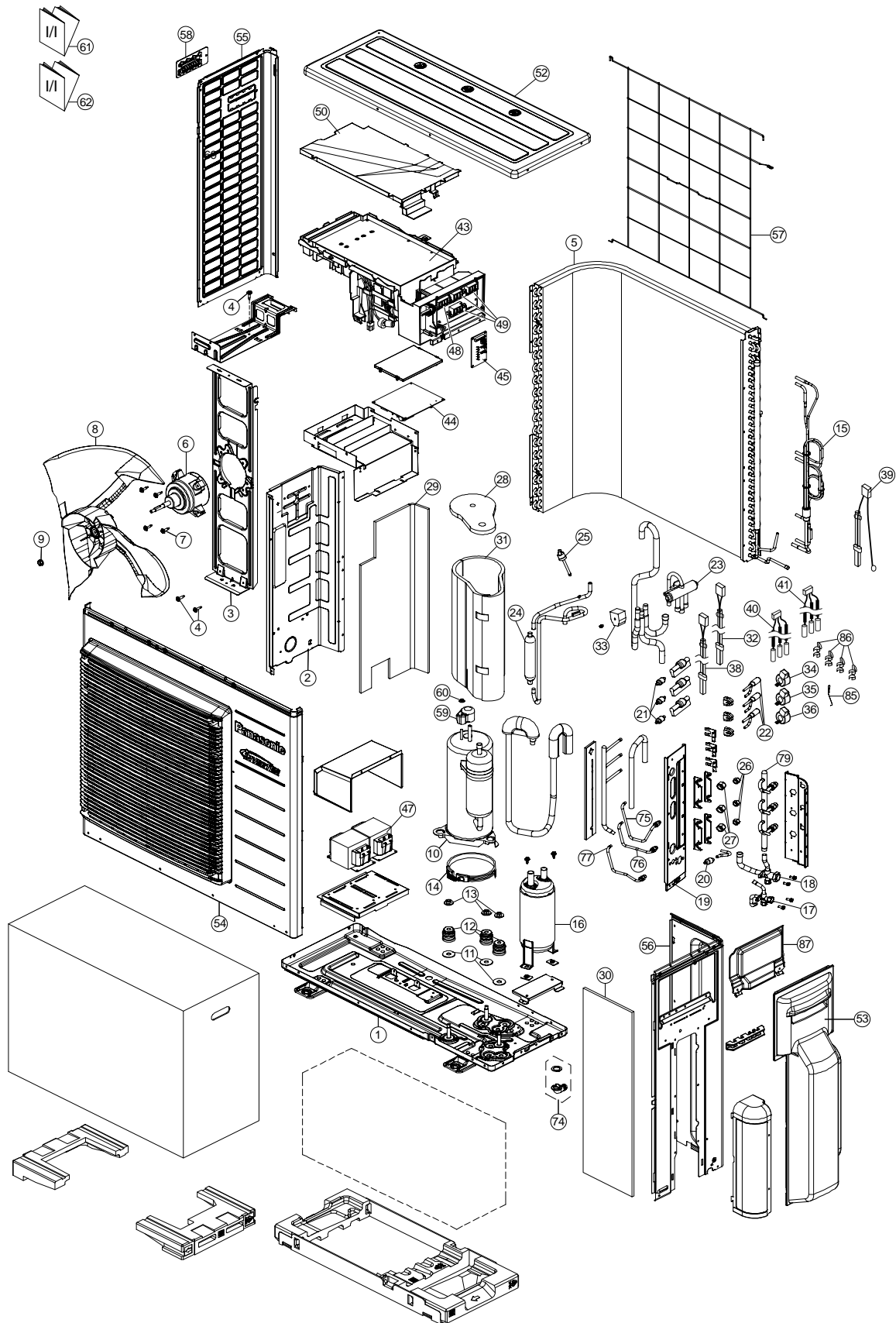

Note

The above exploded view is for the purpose of parts disassembly and replacement.
The non-numbered parts are not kept as standard service parts.

SAFETY	REF. NO.	DESCRIPTION & NAME	QTY.	CU-3E19RBU	REMARK
	1	CHASSIS ASSY	1	CWD52K1239A	
	2	SOUND PROOF BOARD	1	CWH151230	
	3	FAN MOTOR BRACKET	1	CWD541127	
	4	SCREW-BRACKET FAN MOTOR	3	CWH551217	
	5	CONDENSER COMPLETE	1	CWB32C4269	
⚠	6	FAN MOTOR	1	EHDS80CAC	O
	7	SCREW-FAN MOTOR MOUNT	4	CWH551323	
	8	PROPELLER FAN ASSY	1	CWH00K1006	
	9	NUT - PROPELLER FAN	1	CWH561092	
⚠	10	COMPRESSOR	1	5KD184XAB21	O
	11	PACKING-COMP. MOUNT	3	CWB81043	
	12	BUSHING-COMP. MOUNT	3	CWH50055	
	13	NUT-COMPRESSOR MOUNT	3	CWH561049	
	14	HEATER	1	CWA341067	
	15	TUBE ASS'Y (CAP TUBE)	1	CWT01C4955	
	16	ACCUMULATOR	1	CWB131050	
	17	3-WAY VALVE (3/8)	1	CWB011601	
	18	3-WAY VALVE (5/8)	1	CWB011602	
	19	HOLDER COUPLING	1	CWH351303	
	20	STRAINER	1	CWB111062	
	21	STRAINER	3	CWB111063	
	22	EXPANSION VALVE	3	CWB051029	O
	23	4-WAYS VALVE	1	CWB001057	O
	24	DISCHARGE MUFFLER	1	CWB121042	
	25	HEATING PRESSURE SWITCH	1	CWA101013	O
	26	FLARE NUT (1/4)	3	CWT251030	
	27	FLARE NUT (3/8)	3	CWT251031	
	28	SOUND PROOF MATERIAL	1	CWG302246	
	29	SOUND PROOR MATERIAL	1	CWG302520	
	30	SOUND PROOR MATERIAL	1	CWG302521	
	31	SOUND PROOR MATERIAL	1	CWG302955	
	32	SENSOR COMPLETE (DISCHARGE TEMP - CN-DIS)	1	CWA50C2722	O
⚠	33	V-COIL COMPLETE (4 WAY VALVE - CN-HOT)	1	CWA43C2392	O
⚠	34	V-COIL COMPLETE (EXPAND VALVE-WHITE CN-EV1)	1	CWA43C2334	O
⚠	35	V-COIL COMPLETE (EXPAND VALVE-YELLOW CN-EV2)	1	CWA43C2335	O
⚠	36	V-COIL COMPLETE (EXPAND VALVE-BLUE CN-EV3)	1	CWA43C2336	O
	38	SENSOR COMPLETE (DEFROST TEMP - CN-TH2)	1	CWA50C2723	O
	39	SENSOR COMPLETE (HEAT EXCHANGER , OUTDOOR TEMP)	1	CWA50C2710	O
	40	SENSOR COMPLETE (GAS PIPE CN-TH4)	1	CWA50C2620	O
	41	SENSOR COMPLETE (LIQUID PIPE CN-TH3)	1	CWA50C2622	O
⚠	43	ELECTRONIC CONTROLLER-MAIN	1	CWA73C9207R	O
⚠	44	ELECTRONIC CONTROLLER-NOISE FILTER	1	CWA745975	O
⚠	45	ELECTRONIC CONTROLLER-DISPLAY	1	CWA746115	O
⚠	47	REACTOR	2	G0C403J00001	O
⚠	48	TERMINAL BOARD ASSY (L1, L2)	1	CWA28K1195	O
⚠	49	TERMINAL BOARD ASSY (1, 2, 3)	3	CWA28K1196	O
	50	CONTROL BOARD COVER	1	CWH131333	

SAFETY	REF. NO.	DESCRIPTION & NAME	QTY.	CU-3E19RBU	REMARK
	52	CABINET TOP PLATE	1	CWE031131A	
	53	CONTROL BOARD COVER CO.	1	CWH13C1209	
	54	CABINET FRONT PLATE ASSY	1	CWE06K1071	
	55	CABINET SIDE PLATE (L)	1	CWE041490A	
	56	CABINET SIDE PLATE	1	CWE041499A	
	57	WIRE NET	1	CWD041128A	
	58	HANDLE	1	CWE161010	
	59	TERMINAL COVER	1	CWH171035	
	60	NUT-TERMINAL COVER	1	CWH7080300J	
	61	INSTALLATION INSTRUCTION	1	CWF615715	
	62	INSTALLATION INSTRUCTION	1	CWF615716	
	74	ACCESSORY CO. (DRAIN ELBOW)	1	CWG87C900	
	75	TUBE ASSY (LIQUID 1)	1	CWT030577	
	76	TUBE ASSY (LIQUID 2)	1	CWT030578	
	77	TUBE ASSY (LIQUID 3)	1	CWT030579	
	79	MANIFOLD TUBE ASSY (GAS)	1	CWT07K1835	
	85	SPRING - SENSOR	5	CWH711010	
	86	HOLDER-SENSOR	4	CWH32074	
	87	CONTROL BOARD COVER	1	CWH131364	

(Note)

- All parts are supplied from PAPAMY, Malaysia (Vendor Code: 00029488).
- "O" marked parts are recommended to be kept in stock.

18.2 CU-4E24RBU

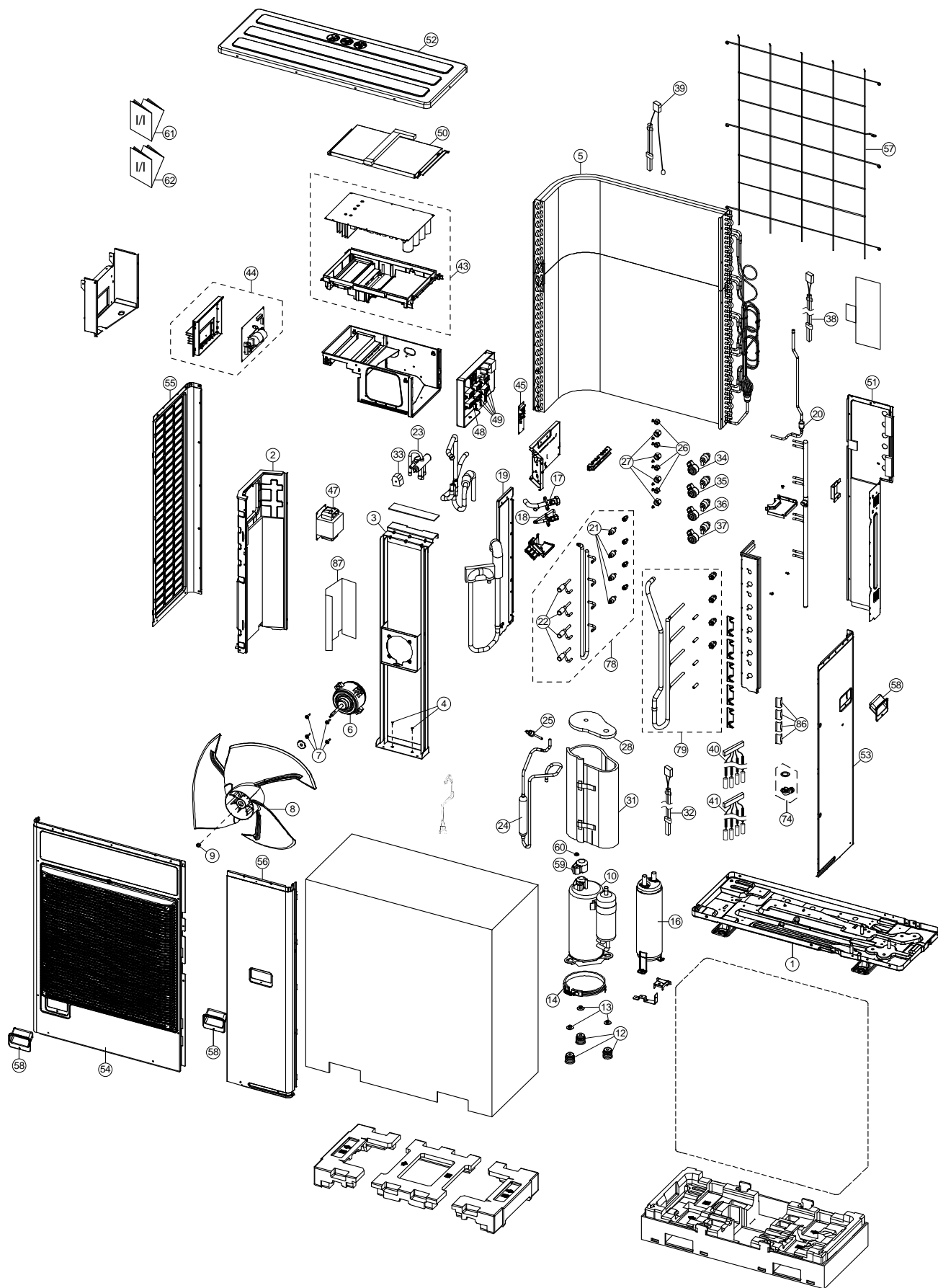

Note
The above exploded view is for the purpose of parts disassembly and replacement.
The non-numbered parts are not kept as standard service parts.

SAFETY	REF.NO.	DESCRIPTION & NAME	QTY.	CU-4E24RBU	REMARK
	1	CHASSIS ASS'Y	1	CWD52K1364A	
	2	SOUND-PROOF BOARD	1	CWH151367	
	3	FAN MOTOR BRACKET	1	CWD54K1081	
	4	SCREW-BRACKET FAN MOTOR	3	CWH551217	
	5	CONDENSER COMPLETE	1	CWB32C3961	
⚠	6	FAN MOTOR	1	L6CBYYL0116	O
	7	SCREW-FAN MOTOR MOUNT	4	CWH551323	
	8	PROPELLER FAN ASSY	1	CWH03K1075	
	9	NUT	1	CWH561092	
⚠	10	COMPRESSOR	1	5KD240XAL21	O
	12	BUSHING - COMPRESSOR MOUNT	3	CWH50055	
	13	NUT-COMPRESSOR MOUNT	3	CWH561049	
	14	CRANKCASE HEATER	1	CWA341098	
	16	ACCUMULATOR	1	CWB131064	
	17	3-WAYS VALVE (GAS)	1	CWB011769	O
	18	3-WAY VALVE (LIQUID)	1	CWB011770	O
	19	HOLDER COUPLING	1	CWH351262	
	20	STRAINER	1	CWB111062	
	21	STRAINER	4	CWB111081	
	22	EXPANSION VALVE	4	CWB051029	O
	23	4-WAYS VALVE	1	CWB001057	O
	24	DISCHARGE MUFFLER	1	CWB121042	
	25	HEATING PRESSURE SWITCH	1	CWA101013	
	26	FLARE NUT (1/4)	4	CWT251030	
	27	FLARE NUT (3/8)	4	CWT251031	
	28	SOUND PROOF MATERIAL	1	CWG302804	
	31	SOUND PROOF MATERIAL	1	CWG302801	
	32	SENSOR-COMPLETE (DISCHARGE TEMP SENSOR CN-DIS)	1	CWA50C3091	O
⚠	33	V-COIL CO. (4 WAY VALVE CN-HOT)	1	CWA43C2392	O
⚠	34	V-COIL CO. (EXPAND VALVE-WHITE CN-EV1)	1	CWA43C2587	O
⚠	35	V-COIL CO. (EXPAND VALVE-YELLOW CN-EV2)	1	CWA43C2588	O
⚠	36	V-COIL CO. (EXPAND VALVE-BLUE CN-EV3)	1	CWA43C2589	O
⚠	37	V-COIL CO. (EXPAND VALVE-RED CN-EV4)	1	CWA43C2590	O
	38	SENSOR-COMPLETE (DEFROST TEMP SENSOR CN-TH2)	1	CWA50C3205	O
	39	SENSOR-COMPLETE (OUTDOOR TEMP SENSOR CN-TH1)	1	CWA50C3206	O
	40	SENSOR-COMPLETE (CN-TH4)	1	CWA50C3328	O
	41	SENSOR-COMPLETE (CN-TH3)	1	CWA50C3329	O
⚠	43	ELECTRONIC CONTROLLER-MAIN	1	CWA73C9208R	O
⚠	44	ELECTRONIC CONTROLLER (NOISE FILTER)	1	CWA73C8058	O
⚠	45	ELECTRONIC CONTROLLER (DISPLAY)	1	CWA747833	O
⚠	47	REACTOR	1	G0C602J00009	O
⚠	48	TERMINAL BOARD ASS'Y (L, N)	1	CWA28K1195	O
⚠	49	TERMINAL BOARD ASS'Y (1, 2, 3)	4	CWA28K1196	O
	50	CONTROL BOARD COVER (TOP PCB)	1	CWH131613	
	51	CABINET REAR PLATE-COMPLETE	1	CWE02C1082	
	52	CABINET TOP PLATE	1	CWE03C1159	
	53	CABINET SIDE PLATE-COMPLETE	1	CWE04C1497	

SAFETY	REF.NO.	DESCRIPTION & NAME	QTY.	CU-4E24RBU	REMARK
	54	CABINET FRONT PLATE-COMPLETE	1	CWE06C1510	
	55	CABINET SIDE PLATE	1	CWE041792A	
	56	CABINET FRONT PLATE-COMPLETE	1	CWE06C1511	
	57	WIRE NET	1	CWD041203A	
	58	HANDLE	2	CWE161021	
	59	TERMINAL COVER	1	CWH171039A	
	60	NUT - TERMINAL COVER	1	CWH7080300J	
	61	INSTALLATION INSTRUCTION	1	CWF616781	
	62	INSTALLATION INSTRUCTION	1	CWF616782	
	74	ACCESSORY CO. (DRAIN ELBOW)	1	CWG87C900	
	78	TUBE ASSY (LIQUID)	1	CWT029448	
	79	TUBE ASSY (GAS)	1	CWT029449	
	86	HOLDER-SENSOR	4	CWH321111	
	87	SOUND PROOF MATERIAL	1	CWG302802	

(Note)

- All parts are supplied from PAPAMY, Malaysia (Vendor Code: 00029488).
- "O" marked parts are recommended to be kept in stock.