

TECHNICAL & SERVICE MANUAL

Panasonic







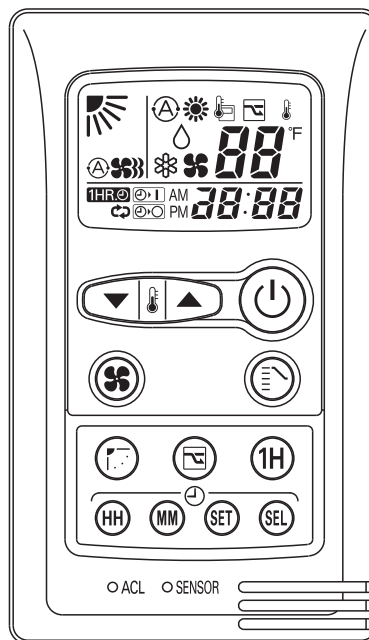

CZ-RD515U















WIRED REMOTE CONTROLLER









| Model No. | Product Code No. |
|-----------|------------------|
| CZ-RD515U | 1 852 361 14 |



SAFETY PRECAUTIONS

- Before doing repair work, please read the " SAFETY PRECAUTIONS" carefully and fully understand them.
- The precautionary items here are divided into " Warning" and " Caution" items.
Items in particular which may cause death or serious injury to the service personnel if the work is not performed correctly, are included in the " Warning" table.
However, even precautionary items identified as " Caution" also have the potential for serious consequences if not performed correctly.
Important safety precautions are described for all items in both categories. Be sure to carefully follow all of them.
- Symbol Indication
 -  : This symbol indicates items to which we need to pay attention.
In this triangle, a definite precautionary item is described.
 -  : This symbol indicates the item to be prohibited.
In or close to this circle, a prohibited item is described.
 -  : This symbol indicates the items requiring special attention or instruction.
In or close to this circle, a prohibited item is described.
- After doing repair work, perform a test run to confirm that there are no abnormalities.
At the same time, explain the precautions in use to the user.

|  Warning | |
|------------------------------------------------------------------------------------------------------------------------------------------------------------------------------------------------------------------------------------------------------------------------------------------------------|---------------------------------------------------------------------------------------------------|
| Before performing an overhaul, disconnect the power plug or power cable from the unit. Performing the work with the power supplied to the unit, may cause an electric shock. |  |
| When repair work or circuit inspection that requires power supply for the air conditioner, is to be performed, do not touch the charging section. Doing so may cause an electric shock. |  Prohibit |
| For the step-up capacitor attached to the electric section, perform the repair work after sufficiently discharging it. Insufficient capacitor discharge may cause an electric shock. |  |
| Do not perform repair work on the electric sections with wet hands. Doing so may cause an electric shock. |  Prohibit |
| Do not start or stop the air conditioner by means of connecting or disconnecting the power plug. Doing so may cause an electric shock or fire. |  Prohibit |
| When conducting repair work only use components included in the parts list for the corresponding unit and perform the work with the appropriate tools. Incorrect or poor repair work may cause an electric shock or fire. |  |
| Never modify the unit. Doing so may cause an electric shock or fire. |  Prohibit |
| Perform all electric work according to local applicable regulations related to electrical equipment or interior wiring regulation and make sure to use the exclusive circuit. Insufficient capacity to the electric circuit or defective arrangement results may cause an electric shock or fire. |  |
| Make sure to replace any power cable or lead wire showing any signs of scratch or deterioration. Failure to do so may cause an electric shock, overheating or fire. |  |
| Make sure that there is no dust on or slack in the power plug and insert fully into the socket. Dust or incomplete connections may cause an electric shock or fire. |  |
| Do not damage or process the power cord, as it may cause an electric shock or fire. |  Prohibit |
| For the wiring between the indoor unit and outdoor unit, securely fix the specified cable onto the terminal plate. Poorly fixed wiring may cause a heat or fire. |  |
| After connecting the wiring between the indoor unit and outdoor unit, attach the terminal cover securely. Incomplete attachment of the terminal cover may cause overheating or fire. |  |

|  Warning | |
|----------------------------------------------------------------------------------------------------------------------------------------------------------------------------------------------------------------------------------------------------------------------------------------|-------------------------------------------------------------------------------------------------|
| If refrigerant gas blows off during the work, do not touch the refrigerant gas as it may cause frostbite. |  Prohibit |
| If refrigerant gas leaks during the work, ventilate the room. If refrigerant gas catches fire, harmful gas may be generated. |  |
| Do not mix any gas other than the specified refrigerant gas in the refrigerating cycle. If air or other contaminants mix with the gas, pressure will become extremely high in the refrigerating cycle, which may cause a unit breakdown." |  Prohibit |
| When the welded section of the compressor intake or discharge pipe is to be disconnected, perform it in a well-ventilated place after sufficiently recovering the refrigerant gas. Any residue gas may jet out refrigerant or refrigerating machine oil, which may cause an injury. |  |
| When the work is to be performed in a high place (About 2 meters or more), make sure to wear a safety helmet, gloves and safety belt. Insufficient safety gear may cause a serious injury in case of a fall. |  |
| When the unit is to be relocated, confirm that the new installation location has sufficient strength for the weight of the unit. Insufficient strength of the installation location and incomplete installation work may cause an injury due to the unit falling. |  |
| When the remote controller batteries are replaced, dispose of the old batteries out of the reach of children. If a child swallows a battery, make sure that the child gets immediate medical attention. |  |













|  Caution | |
|--------------------------------------------------------------------------------------------------------------------------------------------------------------------------|---------------------------------------------------------------------------------------------------|
| Do not wash the air conditioner with water, as this may cause an electric shock or fire. |  Prohibit |
| For the repair work in places with high humidity or moisture, make sure to ground the unit. Failure to do so may cause an electric shock. |  |
| Confirm that the component attachment position, wiring condition, soldering condition and connector connection are normal. If not, it may cause overheating or fire. |  |
| Confirm that the temperature around the compressor is not too high, and then perform the repair work. Failure to do so may cause a burn. |  |
| Perform welding work in a place with good ventilation. If the work is performed in a poorly ventilated area, it might cause a lack of oxygen. |  |
| If the installation plate or attachment frame has deteriorated due to corrosion, etc., replace it. Failure to do so may cause an injury due to the unit falling. |  |
| When the cleaning is to be performed, make sure to turn off the power and pull out the plug. Touching the fan that is rotating at high speed may result in an injury. |  |
| When the indoor unit is to be removed, do not place it on an incline. Doing so may cause wet furniture because water left inside may trickle down. |  Prohibit |
| Do not hold the sharp end of the unit or the aluminum fins, as it may cause an injury to your hand or finger. |  Prohibit |
| After repairs, make sure to measure the insulation resistance and confirm that the value is 1 Mohm or more. Any insulation error may cause an electric shock. |  |
| After repairs, make sure to check the drainage of the indoor unit. Inappropriate drainage may cause wet furniture and floors due to water leakage. |  |

Table of Contents

| | Page |
|----------------------------------------------------------------|------|
| ⚠ SAFETY PRECAUTIONS | 2 |
| TABLE OF CONTENTS | 4 |
| 1. SPECIFICATIONS | 5 |
| 2. APPLICABLE INDOOR UNITS | 6 |
| 3. FUNCTIONS | 6 |
| 4. SELF-DIAGNOSTICS | 7 |
| 4-1. Self-Diagnostics Procedure | 7 |
| 4-2. Self-Diagnostics Table (Ceiling Cassette Type) | 8 |
| 4-3. Self-Diagnostics Table (Wall Mounted Type 1) | 9 |
| 4-4. Self-Diagnostics Table (Wall Mounted Type 2) | 10 |
| APPENDIX A Operating Instructions | A-1 |
| APPENDIX B INSTALLATION INSTRUCTIONS | A-2 |
| (CZ-RD515U) | |
| APPENDIX C INSTALLATION INSTRUCTIONS | A-3 |
| (Installing the Connection Kit for Wall Mounted Type 1) | |
| APPENDIX D INSTALLATION INSTRUCTIONS | A-4 |
| (Installing the Connection Kit for Wall Mounted Type 2) | |

1. SPECIFICATIONS

| Item | Description | |
|----------------------------|-------------------------------------------------------------------------------------------------------------------------------------------------------------------|-----------------------------------------------------------------|
| Signal Transmission Method | Dedicated Remote Controller Cable | |
| Power Source | DC5V supplied from Indoor Unit | |
| Display Panel Type | Liquid Crystal | |
| Display Items | Temperature | Set Temperature Indication (68 °F to 86 °F) |
| | Airflow Direction | Six Directions Indication |
| | Time | AM and PM 12-Hour Indication (Minute Indication Unit: 1 minute) |
| | Temperature Sensor | Displayed when indoor unit sensor is in use |
| Functions | AUTO, HEAT, DRY and FAN Operation NOTE 2 | |
| Operation Section | Push Switch NOTE 2 | |
| Room Temperature Detection | Detection using the Sensor in the Remote Controller or Indoor Unit Temperature Sensor (The detection result is transmitted to the indoor unit every 5 minutes) | |

- NOTE**
- When the indoor unit is modified from one for wireless remote controller to that for wired remote controller, some of the functions becomes unavailable. Therefore, before such modification, make sure to receive an approval of the client. Also, the self-diagnostics procedure is changed.
 - Unavailable Functions : Refer to "3. FUNCTIONS".
 - Self-Diagnostics Procedure : Refer to "4. SELF-DIAGNOSTICS".
 - The mode change or SINGLE/MULTI change-over operation is performed using the slide switch located inside the rear of the remote controller. Refer to "APPENDIX B : INSTALLATION INSTRUCTIONS" for details.

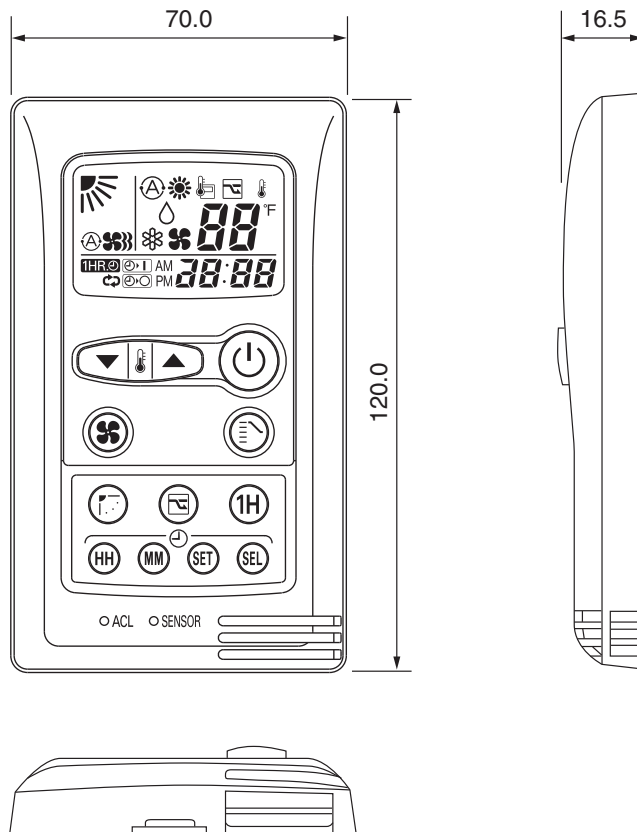

2. APPLICABLE INDOOR UNITS

(1) Ceiling cassette type

| | |
|-----------|------------------------------------------------------|
| Model No. | CS-KE12NB41, CS-KE18NB4UW, CS-KS12NB41, CS-KS18NB4UW |
|-----------|------------------------------------------------------|

(2) Wall mounted type 1

NOTE The connection kit "CZ-RC515U" is required for the installation.

| | |
|-----------|------------------------------------------------------------------------------------------------------------------------------------------------------------------------------------|
| Model No. | CS-KE18NKU, CS-KE24NKU CS-KS18NKU, CS-KS24NKU CS-MKE7NKU, CS-MKE9NKU, CS-MKE12NKU, CS-MKE18NKU, CS-MKE24NKU CS-MKS7NKU, CS-MKS9NKU, CS-MKS12NKU, CS-MKS18NKU, CS-MKS24NKU |
|-----------|------------------------------------------------------------------------------------------------------------------------------------------------------------------------------------|

(3) Wall mounted type 2

NOTE The connection kit "CZ-RC515UA" is required for the installation.

| | |
|-----------|------------------------------------------------|
| Model No. | CS-KE30NKU, CS-KE36NKU, CS-KS30NKU, CS-KS36NKU |
|-----------|------------------------------------------------|

3. FUNCTIONS

When the unit is modified from one for wireless remote controller to that for wired remote controller, the following functions become unavailable.

(1) Ceiling Cassette Type

- Remote Controller
- High Power Operation

(2) Wall Mounted Type

- Remote Controller
- High Power Operation
- Quiet Operation

4. SELF-DIAGNOSTICS

4-1. Self-Diagnostics Procedure

PROCEDURE

After turning on power to the air conditioner, use the remote controller and follow the steps below to execute self-diagnostics.

Step 1: Press and hold the remote controller NIGHT SET BACK (NSB) button and 1 HR TIMER button. Then, press and hold the ACL (reset) button with a pointed object such as the tip of a pen. After 5 seconds, release ACL button first, then release NIGHT SET BACK (NSB) and 1 HR TIMER buttons, "oP-1" (test run) appears, blinking in the remote controller clock display area.

Step 2: Next, press the 1 HR TIMER button once to change the display from "oP-1" to "oP-3" (self-diagnostics). (The display continues to blink.)

Step 3: Finally press the ON/OFF button to engage self-diagnostics mode.

- The self-diagnostics function utilizes the 3 indicator lamps on the main unit, in combinations of ON lamps, blinking lamps, and OFF lamps, to report the existence of sensor trouble or a protective operation. (The lamps blink or remain ON for 5 seconds, then turn OFF for 2 seconds.) Self-diagnostics is completed when the buzzer sounds 3 short beeps.
- A maximum of 3 self-diagnostics reports are displayed, for 5 seconds each, beginning with the most recent report. Following this display the lamps turn OFF. In order to view the self-diagnostics results again, press the ON/OFF button again.
- The 3 lamps remain OFF if no trouble has occurred.

<IMPORTANT> After self-diagnostics is completed, be sure to press the ACL (reset) button to return to normal mode. The air conditioner will not operate if this is not done.

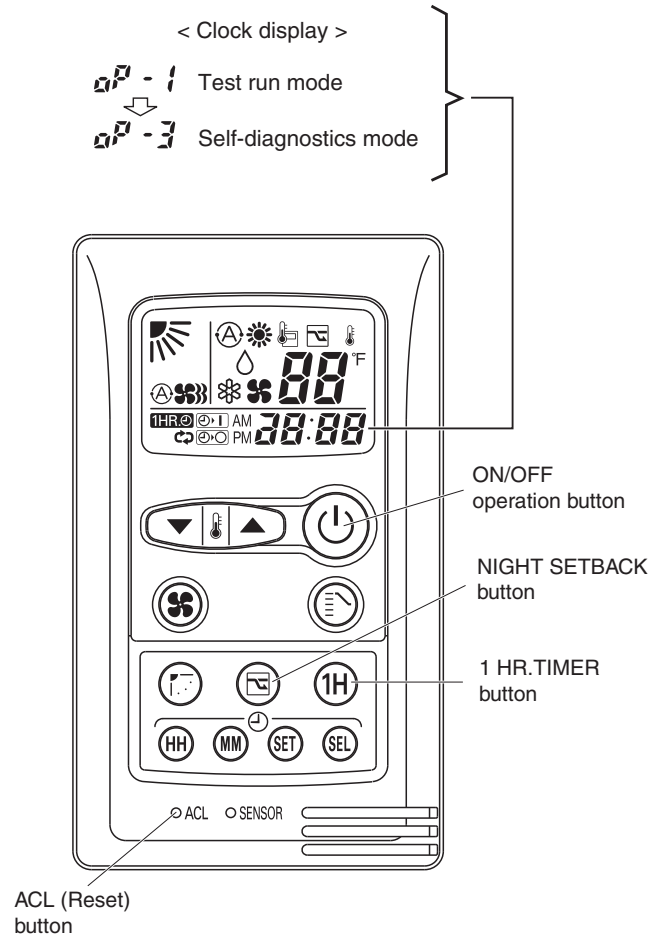

4-2. Self-Diagnostics Table (Ceiling Cassette Type)

INDOOR UNIT

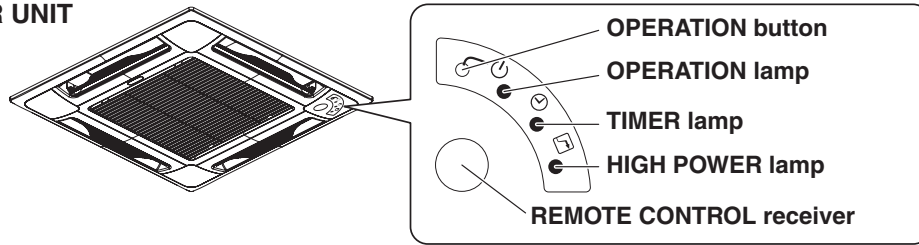

• Since the indications cover various units, the corresponding parts listed below may not be present in some models.

| INDICATION ON INDOOR UNIT | | | × OFF ● BLINKING ☀ ON | | |
|---------------------------|------------|-----------------|--------------------------------------------|----------------------------------------------------------------------------|--------------------------------------------------------------------------------------------------------------------------------------------------------------------------------------------------------------------------------------|
| OPERATION ☀ | TIMER ⌚ | HIGH POWER ⚡ | CODE | DIAGNOSIS CONTENTS | POSSIBLE MALFUNCTION |
| ● | × | × | S01 | ROOM TEMP. SENSOR TROUBLE | (1) OPEN OR SHORT CIRCUIT IN SENSOR (2) POOR CONTACT AT CONNECTOR OR OPEN CIRCUIT AT TERMINAL PRESS-FIT LOCATION. (3) I/D PCB FAILURE (I/D = INDOOR) |
| × | ● | × | S02 | I/D HEAT EXCHANGER TEMP. SENSOR TROUBLE | (1) OPEN OR SHORT CIRCUIT IN SENSOR (2) POOR CONTACT AT CONNECTOR OR OPEN CIRCUIT AT TERMINAL PRESS-FIT LOCATION (3) O/D PCB FAILURE (O/D = OUTDOOR) |
| × | × | ● | S04 | COMPRESSOR TEMP. SENSOR TROUBLE | (1) OPEN OR SHORT CIRCUIT IN SENSOR (2) POOR CONTACT AT CONNECTOR OR OPEN CIRCUIT AT TERMINAL PRESS-FIT LOCATION (3) O/D PCB FAILURE (O/D = OUTDOOR) |
| ● | × | ● | S05 | O/D HEAT EXCHANGER TEMP. SENSOR TROUBLE | (1) OPEN OR SHORT CIRCUIT IN SENSOR (2) POOR CONTACT AT CONNECTOR OR OPEN CIRCUIT AT TERMINAL PRESS-FIT LOCATION (3) O/D PCB FAILURE (O/D = OUTDOOR) |
| × | ● | ● | S06 | O/D AIR TEMP. SENSOR TROUBLE | |
| ● | ● | ● | S07 | O/D CURRENT SENSOR ERROR | O/D PCB FAILURE |
| ☀ | × | × | E01 | I/D-O/D COMMUNICATION TROUBLE (SERIAL COMMUNICATION TROUBLE) | (1) MIS-WIRING (2) AC POWER FAILURE (3) BLOWN FUSE (4) POWER RELAY FAILURE (5) I/D OR O/D PCB FAILURE (6) O/D FAN MOTOR FAILURE (7) REACTOR FAILURE (8) HIGH-PRESSURE SW FAILURE (9) OLR FAILURE (10) MAGNETIC COIL FAILURE |
| × | ☀ | × | E02 | HIC CIRCUIT TROUBLE POWER TR CIRCUIT TROUBLE | (1) HIC OR POWER TR FAILURE (2) O/D FAN NOT OPERATING (3) INSTANTANEOUS POWER STOPPAGE (4) SERVICE VALVE NOT OPENED (5) O/D FAN BLOCKED (6) CONTINUOUS OVERLOAD OPERATION (7) COMPRESSOR FAILURE (8) O/D PCB FAILURE |
| ☀ | ☀ | × | E03 | O/D UNIT EXTERNAL ROM TROUBLE | (1) EXTERNAL ROM DATA FAILURE (2) O/D PCB FAILURE |
| × | × | ☀ | E04 | CURRENT PEAK CUT | (1) INSTANTANEOUS POWER STOPPAGE (2) HIC OR POWER TR FAILURE (3) O/D PCB FAILURE |
| ☀ | × | ☀ | E05 | PAM CIRCUIT TROUBLE ACTIVE CIRCUIT TROUBLE | (1) O/D PCB FAILURE (2) O/D POWER VOLTAGE TROUBLE |
| × | ☀ | ☀ | E06 | COMPRESSOR DISCHARGE TEMP. OVERHEATING PREVENTION | (1) ELECTRIC EXPANSION VALVE FAILURE (2) CHOKED CAPILLARY TUBE (3) INSUFFICIENT GAS (4) CONTINUOUS OVERLOAD OPERATION (5) O/D FAN NOT OPERATING (6) O/D PCB FAILURE |
| ☀ | ☀ | ☀ | E07 | I/D FAN OPERATION TROUBLE | (1) FAN MOTOR FAILURE (2) CONNECTOR CONTACT FAILURE (3) I/D PCB FAILURE |
| ☀ | ● | ● | E08 | 4-WAY VALVE SWITCHING TROUBLE ZERO-CROSS TROUBLE | (1) 4-WAY VALVE FAILURE (HEAT PUMP MODEL ONLY) (2) O/D PCB FAILURE |
| ● | ☀ | ● | E09 | GAS-LOSS PREVENTION | (1) SERVICE VALVE NOT OPENED (2) INSUFFICIENT GAS |
| ☀ | ☀ | ● | E10 | DC COMPRESSOR DRIVE CIRCUIT TROUBLE | (1) OPEN PHASE (2) O/D PCB FAILURE |
| ● | ● | ☀ | E11 | O/D DC FAN OPERATION TROUBLE | (1) FAN MOTOR FAILURE (2) CONNECTOR CONTACT FAILURE (3) O/D PCB FAILURE |
| ☀ | ● | ☀ | E12 | O/D SYSTEM COMM FAILURE, OLR OPERATION, O/D POWER OPEN PHASE, O/D FREEZING | (1) MIS-WIRING (2) BLOWN FUSE (3) POWER RELAY FAILURE (4) O/D PCB FAILURE (5) COMPRESSOR FAILURE |
| ● | ☀ | ☀ | E13 | FREEZING-PREVENTION OPERATION | (1) I/D FAN SYSTEM TROUBLE (2) INSUFFICIENT GAS (3) OPERATION AT LOW TEMPERATURE |
| TIMER LAMP ⌚ | ⌚ | | | FLOAT SWITCH (FS) IS ACTIVATED. | (1) DRAIN PUMP FAILURE (2) FS FAILURE (3) CHOKED DRAIN HOSE |

8512-5261-99100-1

4-3. Self-Diagnostics Table (Wall Mounted Type 1)

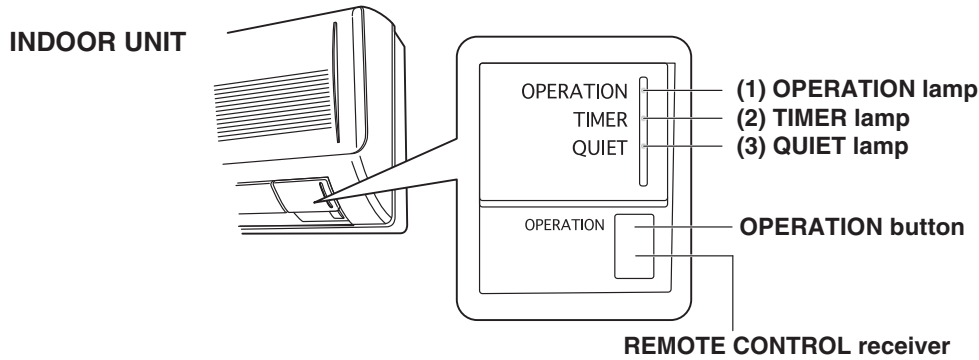

• Since the indications cover various units, the corresponding parts listed below may not be present in some models.

| INDICATION ON INDOOR UNIT | | | × OFF ● BLINKING ☀ ON | | |
|---------------------------|--------------|------------------|--------------------------------------------|----------------------------------------------------------------------------------|--------------------------------------------------------------------------------------------------------------------------------------------------------------------------------------------------------------------------------------|
| QUIET (3) | TIMER (2) | OPERATION (1) | CODE | DIAGNOSIS CONTENTS | POSSIBLE MALFUNCTION |
| × | × | ● | S01 | ROOM TEMP. SENSOR TROUBLE | (1) OPEN OR SHORT CIRCUIT IN SENSOR (2) POOR CONTACT AT CONNECTOR OR OPEN CIRCUIT AT TERMINAL PRESS-FIT LOCATION (FOR HUMIDITY SENSOR, THIS REPRESENTS SHORT-CIRCUIT DETECTION ONLY.) (3) I/D PCB FAILURE (I/D = INDOOR) |
| × | ● | × | S02 | I/D HEAT EXCHANGER TEMP. SENSOR TROUBLE | |
| × | ● | ● | S03 | HUMIDITY SENSOR TROUBLE | |
| ● | × | × | S04 | COMPRESSOR TEMP. SENSOR TROUBLE | (1) OPEN OR SHORT CIRCUIT IN SENSOR (2) POOR CONTACT AT CONNECTOR OR OPEN CIRCUIT AT TERMINAL PRESS-FIT LOCATION (3) O/D PCB FAILURE (O/D = OUTDOOR) |
| ● | × | ● | S05 | O/D HEAT EXCHANGER TEMP. SENSOR TROUBLE | |
| ● | ● | × | S06 | O/D AIR TEMP. SENSOR TROUBLE | |
| ● | ● | ● | S07 | O/D CURRENT SENSOR ERROR | O/D PCB FAILURE |
| × | × | ☀ | E01 | I/D-O/D COMMUNICATION TROUBLE (SERIAL COMMUNICATION TROUBLE) | (1) MIS-WIRING (2) AC POWER FAILURE (3) BLOWN FUSE (4) POWER RELAY FAILURE (5) I/D OR O/D PCB FAILURE (6) O/D FAN MOTOR FAILURE (7) REACTOR FAILURE (8) HIGH-PRESSURE SW FAILURE (9) OLR FAILURE (10) MAGNETIC COIL FAILURE |
| × | ☀ | × | E02 | HIC CIRCUIT TROUBLE POWER TR CIRCUIT TROUBLE | (1) HIC OR POWER TR FAILURE (2) O/D FAN NOT OPERATING (3) INSTANTANEOUS POWER STOPPAGE (4) SERVICE VALVE NOT OPENED. (5) O/D FAN BLOCKED (6) CONTINUOUS OVERLOAD OPERATION (7) COMPRESSOR FAILURE (8) O/D PCB FAILURE |
| × | ☀ | ☀ | E03 | O/D UNIT EXTERNAL ROM TROUBLE | (1) EXTERNAL ROM DATA FAILURE (2) O/D PCB FAILURE |
| ☀ | × | × | E04 | CURRENT PEAK CUT | (1) INSTANTANEOUS POWER STOPPAGE (2) HIC OR POWER TR FAILURE (3) O/D PCB FAILURE |
| ☀ | × | ☀ | E05 | PAM CIRCUIT TROUBLE ACTIVE CIRCUIT TROUBLE | (1) O/D PCB FAILURE (2) O/D POWER VOLTAGE TROUBLE |
| ☀ | ☀ | × | E06 | COMPRESSOR DISCHARGE TEMP. OVERHEATING PREVENTION | (1) ELECTRIC EXPANSION VALVE FAILURE (2) CHOKED CAPILLARY TUBE (3) INSUFFICIENT GAS (4) CONTINUOUS OVERLOAD OPERATION (5) O/D FAN NOT OPERATING (6) O/D PCB FAILURE |
| ☀ | ☀ | ☀ | E07 | I/D FAN OPERATION TROUBLE | (1) FAN MOTOR FAILURE (2) CONNECTOR CONTACT FAILURE (3) I/D PCB FAILURE |
| ● | ● | ☀ | E08 | 4-WAY VALVE SWITCHING TROUBLE ZERO-CROSS TROUBLE | (1) 4-WAY VALVE FAILURE (HEAT PUMP MODEL ONLY) (2) O/D PCB FAILURE |
| ● | ☀ | ● | E09 | GAS-LOSS PREVENTION | (1) SERVICE VALVE NOT OPENED (2) INSUFFICIENT GAS |
| ● | ☀ | ☀ | E10 | DC COMPRESSOR DRIVE CIRCUIT TROUBLE | (1) OPEN PHASE (2) O/D PCB FAILURE |
| ☀ | ● | ● | E11 | O/D DC FAN OPERATION TROUBLE | (1) FAN MOTOR FAILURE (2) CONNECTOR CONTACT FAILURE (3) O/D PCB FAILURE |
| ☀ | ● | ☀ | E12 | O/D SYSTEM COMM FAILURE, OLR OPERATION, O/D POWER OPEN PHASE, O/D FREEZING | (1) MIS-WIRING (2) BLOWN FUSE (3) POWER RELAY FAILURE (4) O/D PCB FAILURE (5) COMPRESSOR FAILURE |
| ☀ | ☀ | ● | E13 | FREEZING-PREVENTION OPERATION | (1) I/D FAN SYSTEM FAILURE (2) INSUFFICIENT GAS (3) OPERATION AT LOW TEMPERATURE |

4-4. Self-Diagnostics Table (Wall Mounted Type 2)

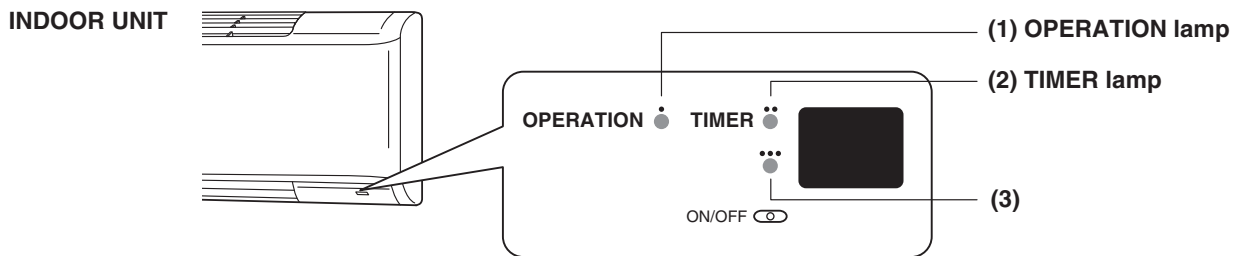

• Since the indications cover various units, the corresponding parts listed below may not be present in some models.

| INDICATION ON INDOOR UNIT | | | | ✕ ... OFF ... BLINKING ... ON | | |
|---------------------------|---------|--------------|-----------------|---------------------------------------|----------------------------------------------------------------------------|-----------------------------------------------------------------------------------------------------------------------------------------------------------------------------------------------------------------------------|
| ALARM CODE | (3) ... | TIMER (2) .. | OPERATION (1) . | ERROR CODE | DIAGNOSIS CONTENTS | POSSIBLE MALFUNCTION |
| F10 | ✕ | ✕ | | S01 | ROOM TEMP. SENSOR TROUBLE | (1) OPEN OR SHORT CIRCUIT IN SENSOR |
| F02 | ✕ | | ✕ | S02 | I/D HEAT EXCHANGER TEMP. SENSOR TROUBLE | (2) POOR CONTACT AT CONNECTOR OR OPEN CIRCUIT AT TERMINAL PRESS-FIT LOCATION (FOR HUMIDITY SENSOR, THIS REPRESENTS SHORT-CIRCUIT DETECTION ONLY.) |
| F13 | ✕ | | | S03 | HUMIDITY SENSOR TROUBLE | (3) I/D PCB FAILURE (I/D = INDOOR) |
| F04/F12 | | ✕ | ✕ | S04 | COMPRESSOR TEMP. SENSOR TROUBLE | (1) OPEN OR SHORT CIRCUIT IN SENSOR |
| F09/F12-F18 | | ✕ | | S05 | O/D HEAT EXCHANGER TEMP. SENSOR TROUBLE | (2) POOR CONTACT AT CONNECTOR OR OPEN CIRCUIT AT TERMINAL PRESS-FIT LOCATION |
| F08/F21-F24 | | | ✕ | S06 | O/D AIR TEMP. SENSOR TROUBLE | (3) O/D PCB FAILURE (O/D = OUTDOOR) |
| F27 | | | | S07 | O/D CURRENT SENSOR ERROR | O/D PCB FAILURE |
| E05 | ✕ | ✕ | | E01 | I/D-O/D COMMUNICATION TROUBLE (SERIAL COMMUNICATION TROUBLE) | (1) MIS-WIRING (2) AC POWER FAILURE (3) BLOWN FUSE (4) POWER RELAY FAILURE (5) I/D OR O/D PCB FAILURE (6) O/D FAN MOTOR FAILURE (7) REACTOR FAILURE (8) HIGH-PRESSURE SW FAILURE (9) OLR FAILURE (10) MAGNETIC COIL FAILURE |
| P26 | ✕ | | ✕ | E02 | HIC CIRCUIT TROUBLE POWER TR CIRCUIT TROUBLE | (1) HIC OR POWER TR FAILURE (2) O/D FAN NOT OPERATING (3) INSTANTANEOUS POWER STOPPAGE (4) SERVICE VALVE NOT OPENED. (5) O/D FAN BLOCKED (6) CONTINUOUS OVERLOAD OPERATION (7) COMPRESSOR FAILURE (8) O/D PCB FAILURE |
| F31 | ✕ | | | E03 | O/D UNIT EXTERNAL ROM TROUBLE | (1) EXTERNAL ROM DATA FAILURE (2) O/D PCB FAILURE |
| P16 | | ✕ | ✕ | E04 | CURRENT PEAK CUT | (1) INSTANTANEOUS POWER STOPPAGE (2) HIC OR POWER TR FAILURE (3) O/D PCB FAILURE |
| P07 | | ✕ | | E05 | PAM CIRCUIT TROUBLE ACTIVE CIRCUIT TROUBLE | (1) O/D PCB FAILURE (2) O/D POWER VOLTAGE TROUBLE |
| P03 | | | ✕ | E06 | COMPRESSOR DISCHARGE TEMP. OVERHEATING PREVENTION | (1) ELECTRIC EXPANSION VALVE FAILURE (2) CHOKED CAPILLARY TUBE (3) INSUFFICIENT GAS (4) CONTINUOUS OVERLOAD OPERATION (5) O/D FAN NOT OPERATING (6) O/D PCB FAILURE |
| P01 | | | | E07 | I/D FAN OPERATION TROUBLE | (1) FAN MOTOR FAILURE (2) CONNECTOR CONTACT FAILURE (3) I/D PCB FAILURE |
| P19 | | | | E08 | 4-WAY VALVE SWITCHING TROUBLE ZERO-CROSS TROUBLE | (1) 4-WAY VALVE FAILURE (HEAT PUMP MODEL ONLY) (2) O/D PCB FAILURE |
| P15 | | | | E09 | GAS-LOSS PREVENTION | (1) SERVICE VALVE NOT OPENED (2) INSUFFICIENT GAS |
| P29 | | | | E10 | DC COMPRESSOR DRIVE CIRCUIT TROUBLE | (1) OPEN PHASE (2) O/D PCB FAILURE |
| P22 | | | | E11 | O/D DC FAN OPERATION TROUBLE | (1) FAN MOTOR FAILURE (2) CONNECTOR CONTACT FAILURE (3) O/D PCB FAILURE |
| E07/P04/P05 P20/P27 | | | | E12 | O/D SYSTEM COMM FAILURE, OLR OPERATION, O/D POWER OPEN PHASE, O/D FREEZING | (1) MIS-WIRING (2) BLOWN FUSE (3) POWER RELAY FAILURE (4) O/D PCB FAILURE (5) COMPRESSOR FAILURE |
| P11 | | | | E13 | FREEZING-PREVENTION OPERATION | (1) I/D FAN SYSTEM TROUBLE (2) INSUFFICIENT GAS (3) OPERATION AT LOW TEMPERATURE |

APPENDIX A Operating Instructions

CZ-RD515U

(852-6-4181-230-00-1)

Operating Instructions Wired Remote Controller

Model No. **CZ-RD515U**

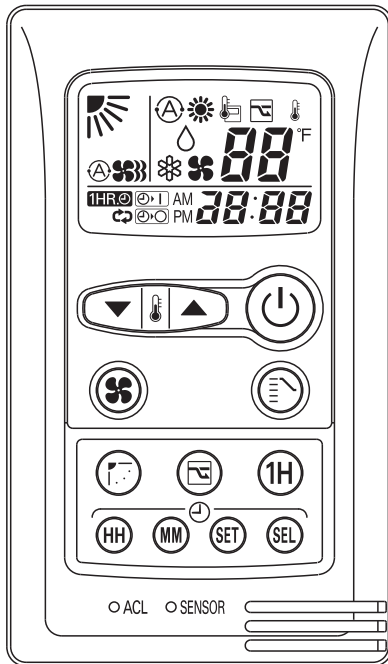

This wired remote controller is designed for both the “COOL/DRY/HEAT Model” and “COOL/DRY Model” indoor unit.

Once the wired remote controller is connected, the wireless remote controller cannot be used.



Before operating the unit, read these operating instructions thoroughly and keep them for future reference.

FEATURES

- Microprocessor Controlled Operation**
 The interior compartment of the remote controller contains several features to facilitate automatic operation, easy logically displayed for easy use.
- 24-Hour ON or OFF Timer**
 This timer can be set to automatically turn the unit on or off at any time within a 24 hour period.
- 1-Hour OFF Timer**
 This timer can be set to automatically turn off the unit at any time after one hour.
- Night Setback**
 This function saves energy by controlling operation to provide a quieter operating sound than normal.
- Automatic and 3-step Fan Speed**
 Auto/High/Medium/Low
- Air Sweep Control**
 This function moves a flap up and down in the air outlet, directing air in a sweeping motion around the room and providing comfort in every corner.
- Automatic Restart Function for Power Failure**
 Even when power failure occurs, preset programmed operation can be reactivated once power resumes.
- Automatic Switching between Cooling and Heating**
 This unit automatically switches between cooling operation and heating operation according to the difference between the room temperature and the temperature setting.
 (This function is available only for "Single use" of COOL/DRY/HEAT Model.)
- Hot Start Heating System**
 Right from the start, the air is warm and comfortable. This system prevents any cold blasts at the beginning while the heat pump is warming up, or even defrosting.
 (This function is available only for COOL/DRY/HEAT Model.)

NOTE

- Since the wired remote controller is designed to be commonly used for various air conditioners, some of the functions of the wireless remote controller supplied with the indoor unit cannot be used.
- "Single use" means that only one indoor unit is connected with one outdoor unit in a one-unit-to-one-unit configuration.
- "Multiple use" (i.e. Flexi-Multi system) means that two or more indoor units are connected with one outdoor unit in a multiple-unit-to-one-unit configuration.

CONTENTS

| | Page |
|-------------------------------------------------------------|------|
| FEATURES | 2 |
| PRODUCT INFORMATION | 2 |
| SAFETY PRECAUTIONS | 2 |
| INSTALLATION LOCATION | 3 |
| ELECTRICAL REQUIREMENTS | 3 |
| SAFETY INSTRUCTIONS | 3 |
| REMOTE CONTROLLER | 4 |
| OPERATION WITH THE REMOTE CONTROLLER | 7 |
| 1. Automatic Operation (only for COOL/DRY/HEAT Model) | 7 |
| 2. Manual Operation | 7 |
| 3. Adjusting the Fan Speed | 8 |
| 4. Fan Only | 8 |
| 5. Night Setback Mode | 8 |
| SPECIAL REMARKS | 8 |
| SETTING THE TIMER | 9 |
| USING THE 1-HOUR OFF TIMER | 10 |
| ADJUSTING THE AIRFLOW DIRECTION | 10 |

PRODUCT INFORMATION

If you have problems or questions concerning your wired remote controller, you will need the following information.

Model No. _____
 Date of purchase _____
 Dealer's address _____
 Phone number _____

SAFETY PRECAUTIONS

The following symbols used in this manual, alert you to potentially dangerous conditions to users, service personnel or the appliance:



WARNING

This symbol refers to a hazard or unsafe practice which can result in severe personal injury or death.



CAUTION

This symbol refers to a hazard or unsafe practice which can result in personal injury or product or property damage.

INSTALLATION LOCATION

We recommend that this wired remote controller be installed properly by qualified installation technicians in accordance with the Installation Instructions provided with the unit.



WARNING

- Do not install this wired remote controller where there are fumes or flammable gases, or in an extremely humid space such as a greenhouse.
- Do not install the wired remote controller where excessively high heat-generating objects are placed.

Avoid:

To protect the air conditioner from heavy corrosion, avoid installing the outdoor unit where salty sea water can splash directly onto it or in sulphurous air near a spa.

ELECTRICAL REQUIREMENTS

1. All wiring must conform to the local electrical codes. Consult your dealer or a qualified electrician for details.
2. Each unit must be properly grounded with a ground (or earth) wire or through the supply wiring.
3. Wiring must be done by a qualified electrician.

NOTE

Pull off the power plug from a receptacle, or switch off the breaker, or switch off the power disconnecting mean to isolate the air conditioner from the main power supply when not in use for a long time.



SAFETY INSTRUCTIONS

- Read this Instruction Manual carefully before using this air conditioner. If you still have any difficulties or problems, consult your dealer for help.
- This air conditioner is designed to give you comfortable room conditions. Use this only for its intended purpose as described in this Instruction Manual.







WARNING

- Confirm to authorized dealer or specialist on usage of specified refrigerant type. Using of refrigerant other than the specified type may cause product damage, burst and injury etc.
- Never touch the unit with wet hands.
- Never use or store gasoline or other flammable vapor or liquid near the air conditioner — it is very dangerous.
- Do not use this appliance in a potentially explosive atmosphere.
- This air conditioner has no ventilator for intaking fresh air from outdoors. You must open doors or windows frequently when you use gas or oil heating appliances in the same room, which consume a lot of oxygen from the air. Otherwise there is a risk of suffocation in an extreme case.
- Do not swallow the battery.
- After removing the battery from remote controller, keep it away from the reach of children. The battery can cause death by suffocation if swallowed.

- To prevent possible hazards from insulation failure, the unit must be grounded. 
- Do not clean inside the indoor and outdoor units by users. Engage authorized dealer or specialist for cleaning.
- In case of malfunction of this appliance, do not repair by yourself. Contact to the sales dealer or service dealer for a repair.
- Refrigerant gas leakage may cause fire.
- For safety, be sure to turn the air conditioner off and also to disconnect the power before cleaning. 
- Pull off the power plug from a receptacle, or switch off the breaker, or switch off the power disconnecting mean to isolate the air conditioner from the main power supply in case of emergency.



CAUTION

- Do not turn the air conditioner on and off from the power mains switch. Use the ON/OFF operation button.
- Do not stick anything into the air outlet of the outdoor unit. This is dangerous because the fan is rotating at high speed. 
- Do not touch the air inlet or the sharp aluminum fins of the outdoor unit. You may get injured. 
- Keep the fire alarm and the air outlet at least 1.5m away from the unit.
- Do not let children play with the air conditioner.
- Do not cool or heat the room too much if babies or invalids are present.
- Do not sit or step on the unit. You may fall down accidentally. 
- Do not stick any object into the FAN CASE. You may be injured and the unit may be damaged. 

NOTICE

- This device complies with part 15 of the FCC Rules. Operation is subject to the following two conditions: (1) This device may not cause harmful interference, and (2) this device must accept any interference received, including interference that may cause undesired operation.
- This equipment has been tested and found to comply with the limits for a Class B digital device, pursuant to part 15 of the FCC Rules. These limits are designed to provide reasonable protection against harmful interference in a residential installation. This equipment generates, uses and can radiate radio frequency energy and, if not installed and used in accordance with the instructions, may cause harmful interference to radio communications. However, there is no guarantee that interference will not occur in a particular installation. If this equipment does cause harmful interference to radio or television reception, which can be determined by turning the equipment off and on, the user is encouraged to try to correct the interference by one or more of the following measures:
 - Reorient or relocate the receiving antenna.
 - Increase the separation between the equipment and receiver.
 - Connect the equipment into an outlet on a circuit different from that to which the receiver is connected.
 - Consult the dealer or an experienced radio/TV technician for help.
- FCC Caution: To assure continued compliance, follow the attached installation instructions. Any changes or modifications not expressly approved by the party responsible for compliance could void the user's authority to operate this equipment.

REMOTE CONTROLLER

NOTE

The descriptions on the AUTO (Ⓐ) or HEAT (☀️) operation mode are only for the “COOL/DRY/HEAT Model,” and not for the “COOL/DRY Model.”

Display

Information on the operating conditions is displayed while the remote controller is switched on. If the unit is turned off, only the mode that was set previously is still displayed.

Temperature setting buttons (TEMP.)

Press the ▲ button to increase the set temperature.
 Press the ▼ button to reduce the set temperature.
 The temperature setting changes by 2 °F each time one of the TEMP. buttons is pressed.

FAN SPEED selector button

- Ⓐ 🌀 : The air conditioner automatically decides the fan speeds.
- 🌀 : High fan speed
- 🌀 : Medium fan speed
- 🌀 : Low fan speed

NIGHT SETBACK button

For details, see “5. Night Setback Mode”. When you press this button in the HEAT, DRY or COOL mode, the 🌙 mark appears in the display, and the remote controller will automatically adjust the set temperature to save energy.

FLAP button

Press this button either to select the setting of the airflow direction to one of the six possible positions manually or to select the sweep function which moves the flap up and down automatically.

- 🌀 : The airflow direction can be set manually. (six positions)
- 🌀 : The flap moves up and down automatically.

NOTE

When you press the FLAP button, the air flow direction will be changed one by one as follows.

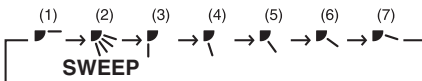

Timer and Present Time setting buttons

First, press the SET button to select the mode (ON, OFF and Present Time settings) you want.

Each time you press the “HH” button, the hours advance by one. (PM0, PM1.....PM11, AM0, AM1.....AM11)

Each time you press the “MM” button, the minutes advance by one when setting Present Time and by ten when setting ON and OFF Time.

SET button

For details, see “SETTING THE TIMER”.

Press this button to select the mode you want to program.

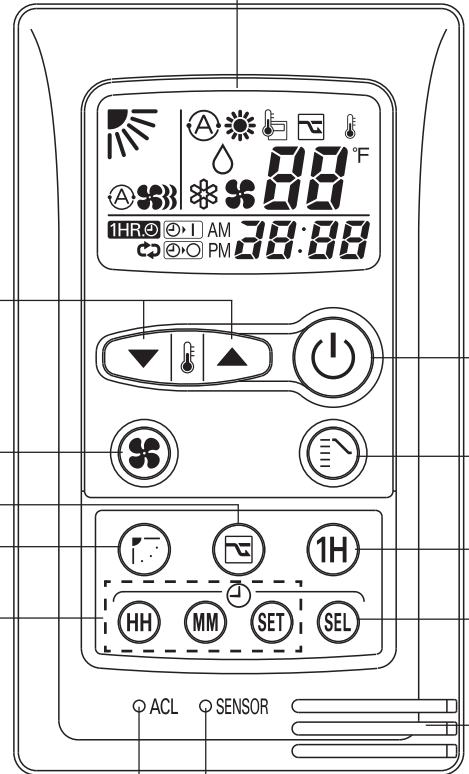

ACL button (ALL CLEAR)

When you press the ACL button while the operation button is ON, all settings are cleared. Press the ACL button if the air conditioner is not operating correctly.

ON/OFF operation button

This button is for turning the air conditioner on and off.

MODE selector button

Use this button to select AUTO, HEAT, DRY, COOL or FAN mode.

(AUTO)  : When this setting is selected, the air conditioner calculates the difference between the thermostat setting and the room temperature and automatically switches to the "COOL" or "HEAT" mode as appropriate. (This function is available only for "Single use" of COOL/DRY/HEAT Model.)

(HEAT)  : The air conditioner makes the room warmer.

(DRY)  : The air conditioner reduces the humidity in the room.

(COOL)  : The air conditioner makes the room cooler.

(FAN)  : The air conditioner works only as a circulation fan except for "Multiple use" of COOL/DRY/HEAT Model.

1 HR. TIMER button (1-HOUR OFF TIMER)

1HR  : When you press this button, regardless of whether the unit is operating or stopping, the unit operates for one hour and then shuts down.

TIMER SELECT button

No display : The timer does not operate.

 : The air conditioner starts at the set time.

 : The air conditioner stops at the set time.

 : The air conditioner stops and starts, or starts and stops, at the set times every day.

Sensor

A temperature sensor inside the remote controller senses the room temperature.

SENSOR button

When you press this button (use a small-tipped object such as a ballpoint pen), the  mark will disappear at the display. And the room temperature is detected by the sensor which is built into the remote controller and the air conditioner is controlled accordingly.

NOTE

If the remote controller is located near a heat source, such as a space heater or in direct sunlight, press the SENSOR button to switch to the sensor on the indoor unit.

NOTE

The indoor fan runs continuously when the system is in normal operation. It does not turn off when the desired room temperature is reached. If Night Set Back mode is selected, the fan will turn off intermittently during cooling operation in order to control air flow.

REMOTE CONTROLLER (DISPLAY)

Displayed when indoor unit sensor is in use

Displayed when operating NIGHT SETBACK mode

Displayed when setting temperature

Displayed when temperature is shown

Displayed when setting timer

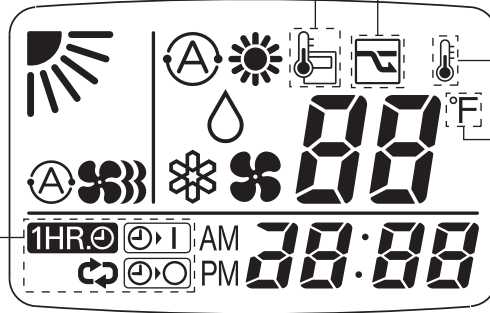

Symbols

(1) Operation mode

AUTO
(only for COOL/DRY/HEAT Model)
HEAT
(only for COOL/DRY/HEAT Model)



MILD DRY



COOL



FAN



(2) Fan speed

Automatic operation



HIGH



MEDIUM



LOW



(3) Temperature setting

60 – 86 °F



When set to 80 °F temperature indication



(4) Timer

24-hour clock with ON/OFF program Timer



ON Timer.



OFF Timer.

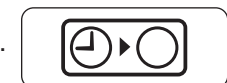

1-hour OFF Timer.



(5) NIGHT SETBACK



(6) Flap angle indication



Sweep indication



OPERATION WITH THE REMOTE CONTROLLER

1. Automatic Operation (only for COOL/DRY/HEAT Model)

- Single use
This unit automatically switches between cooling operation and heating operation according to the difference between the room temperature and the temperature setting.
- Multiple use
The air conditioner calculates the difference between the thermostat setting and room temperature, and automatically determines the mode to operate under cooling or heating. Then, the air conditioner continuously operates under the mode selected at initial operation.

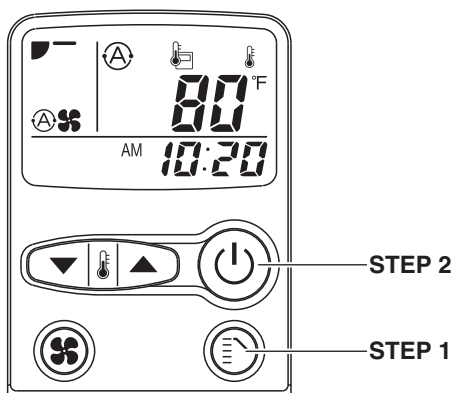

NOTE Check that the circuit breaker on the power panel is turned on.

Once mode is selected and the unit is preset by following the steps below, you can have the air conditioner automatically bring the room to the desired temperature simply by pressing the ON/OFF operation button.

| | |
|---------------|-------------------------------------|
| STEP 1 | Press the MODE selector button to . |
| STEP 2 | Press the ON/OFF operation button. |

To stop the air conditioner, press the ON/OFF operation button again.

NOTE To change the temperature setting; press the temperature setting buttons and change the setting to the desired temperature.

2. Manual Operation

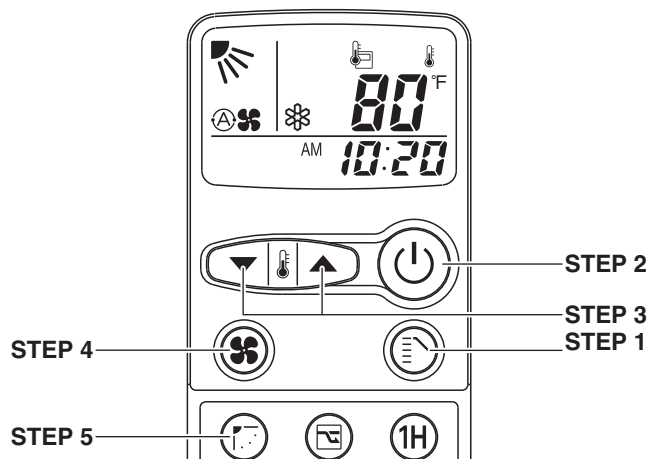

NOTE Check that the circuit breaker on the power panel is turned on.

If the automatic operation settings of the unit do not meet your needs, press the setting buttons as described below and change the settings as desired.

| | |
|---------------|------------------------------------------------------------------------------------------------------------------------------------------------------------------------------------------------------------------------------------------|
| STEP 1 | Press the MODE selector button and select the desired mode. For heating operation → For dehumidifying operation → For cooling operation → For fan only operation → (No Fan mode in "Multiple use" of COOL/DRY/HEAT Model) |
| STEP 2 | To start the air conditioner, press the ON/OFF operation button. |
| STEP 3 | Press the TEMP. setting buttons to change the temperature setting to the desired temperature. Adjustable temperature range: 86 °F max. 60 °F min. |
| STEP 4 | Set the FAN SPEED selector button to the setting you want. |
| STEP 5 | Press the FLAP button and set the airflow direction as desired. (Refer to "ADJUSTING THE AIRFLOW DIRECTION" on page 10.) |

To stop the air conditioner, press the ON/OFF operation button again.

- NOTE**
- Choose the best position in the room for the remote controller, which also acts as the sensor for room comfort and transmits the operating instructions. Once you've found this best position, always keep the remote controller there.
 - This appliance has a built-in 5-minute time delay circuit to ensure reliable operation. When the operation button is pressed, the compressor will start running within three minutes. In the event of power failure, the unit will stop.
 - The display on the remote controller shows the setting temperature and not the room temperature.
 - When multiple indoor units are used and units in other rooms are already operating, they will be operating with the same mode as the operating indoor units. (only for "Multiple use" of COOL/DRY/HEAT Model)

EG

3. Adjusting the Fan Speed

A. Automatic fan speed

Simply set the FAN SPEED selector button to the position.

This automatically sets the best fan speed for the room temperature.

B. Manual fan speed

If you want to adjust fan speed manually during operation, just set the FAN SPEED selector button as desired. [, , or]

4. Fan Only

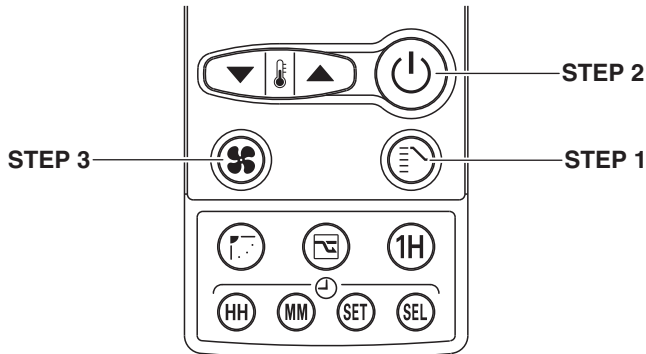

If you want to circulate air without any temperature control, follow these steps:

| | |
|---------------|---------------------------------------------------------------------------------------|
| STEP 1 | Press the MODE selector button to switch to the fan mode . |
| STEP 2 | Press the ON/OFF operation button. |
| STEP 3 | Press the FAN SPEED selector button to select the fan speed of your choice (, , or). |

NOTE There is no FAN only function in "Multiple use" of COOL/DRY/HEAT Model.

5. Night Setback Mode

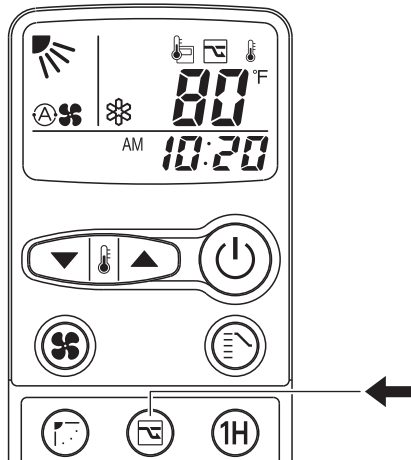

Night Setback Mode is used for saving energy.

Press the NIGHT SETBACK button while unit is operating. The mark appears in the display.

To release the night setback function, press the NIGHT SETBACK button again.

A. In Cooling and DRY Mode: (and)

When the night setback mode is selected, the air conditioner automatically raises the temperature setting 2 °F when 30 minutes have passed after the selection was made, and then another 2 °F after another 30 minutes have passed, regardless of the indoor temperature when night setback was selected. This enables you to save energy without sacrificing comfort. This function is convenient when gentle cooling is needed.

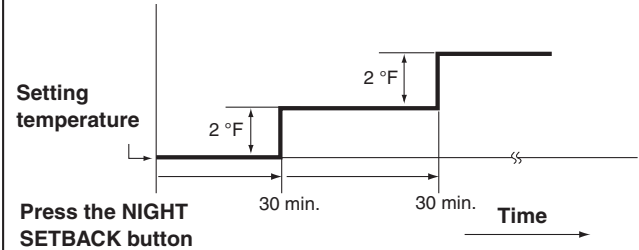

B. In Heating Mode: () (only for COOL/DRY/HEAT Model)

When the night setback mode is selected, the air conditioner automatically lowers the temperature setting 4 °F when 30 minutes have passed after the selection was made, and then another 4 °F after another 30 minutes have passed, regardless of the indoor temperature when night setback was selected. This enables you to save energy without sacrificing comfort. This function is convenient when gentle heating is needed.

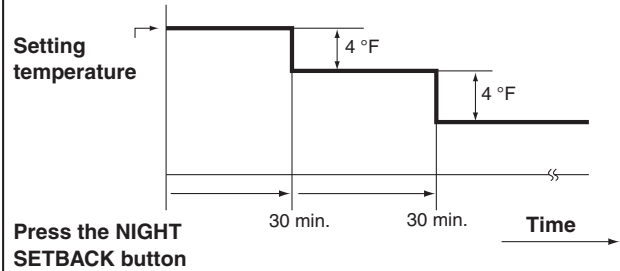

SPECIAL REMARKS

Power failure during operation

In the event of power failure, the unit will stop. When the power is resumed within 8 hours, the unit will restart automatically in approximately five minutes, or 15 minutes in "Multiple use" of COOL/DRY/HEAT Model on AUTO mode by the remote controller.

Remote Controller

The remote controller sends the setting condition to the air conditioner regularly at five minute intervals.

Remote Controller Display

If the display malfunctions, press the ACL button. This resets the remote controller back to the initial settings. Make the settings again.

SETTING THE TIMER

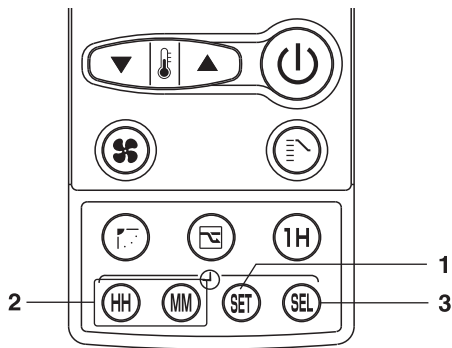

1. How to set the present time

(Example) To set to 9:10 pm.

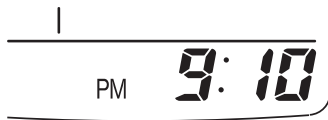

| Operation | Indication |
|---------------------------------------------------------------------------------------------------|-----------------------------------------------------------------------------------------------|
| 1. Press the SET button three times. | The time indication alone flashes. |
| 2. • Press the HH button until PM 9 is displayed. • Press the MM button until 10 is displayed. | The display will flash for 10 sec. and automatically stop flashing except for the “:” symbol. |

2. How to set the OFF time

(Example) To stop the air conditioner at 11:30 pm.

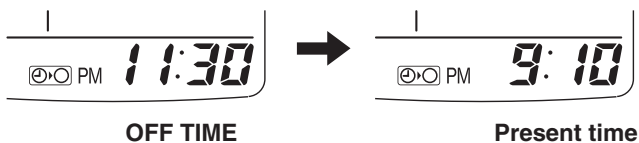

| Operation | Indication |
|----------------------------------------------------------------------------------------------------|-----------------------------------------------------------------------------------------|
| 1. Press the SET button twice. | The timer indication alone flashes and the previous set-time is only displayed. |
| 2. • Press the HH button until PM 11 is displayed. • Press the MM button until 30 is displayed. | The display will change automatically back to show the present time after about 10 sec. |
| 3. Press the TIMER SELECT button twice to set OFF time. | The present time and are displayed. |

To cancel the setting, press the TIMER SELECT button twice.

3. How to set the ON time

(Example) To start operation at 7:10 am.

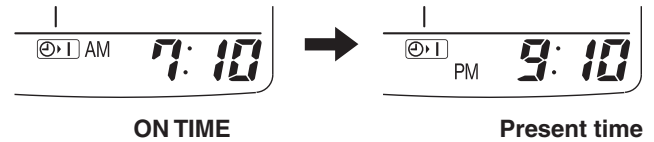

| Operation | Indication |
|---------------------------------------------------------------------------------------------------|-----------------------------------------------------------------------------------------|
| 1. Press the SET button once. | The timer indication alone flashes and the previous set-time is only displayed. |
| 2. • Press the HH button until AM 7 is displayed. • Press the MM button until 10 is displayed. | The display will change automatically back to show the present time after about 10 sec. |
| 3. Press the TIMER SELECT button once to set ON time. | The present time and are displayed. |

To cancel the setting, press the TIMER SELECT button three times.

4. How to set daily ON/OFF repeat timer

(Example) To start operation at 7:10 am. and stop the air conditioner at 11:30 pm.

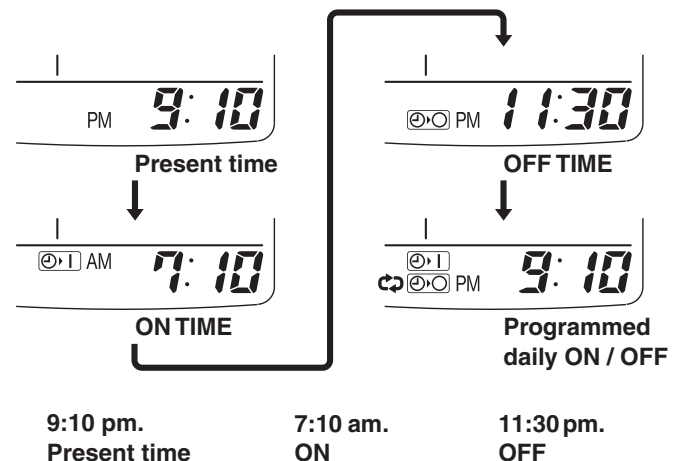

| Operation | Indication |
|-------------------------------------------------|----------------------------------------------|
| Set the timer ON/OFF times as shown in 2 and 3. | The present time PM 9:10 and are displayed. |

To cancel the setting, press the TIMER SELECT button once.

NOTE

You can check the timer ON/OFF times after you have set them by pressing the SET button.

5. Backup function

Even if the main power supply to the unit is turned off, the remote controller will store the previous settings in its internal memory for up to 8 hours. If the power is not turned back on within 8 hours, the previous settings will be lost. In this case, the mode settings must be reset by the user.

USING THE 1-HOUR OFF TIMER

1. 1-Hour OFF Timer

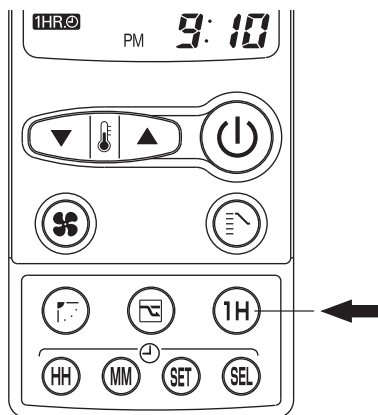

This function causes the unit to operate for one hour and then stop, regardless of whether the unit is on or off when this button is pressed.

The **1HR** indicator in the display indicates that this function is operating.

Setting procedure:

Regardless of whether the unit is operating or stopped, press the 1 HR. TIMER button.

1HR appears in the display.

Cancellation procedure:

Press the ON/OFF operation button to turn the unit off, wait for the unit to stop operating, and then press the ON/OFF operation button again.

The 1-Hour Timer function is now cancelled and the unit operates normally.

NOTE

- If, while the 1-Hour Timer function is operating, the 1HR. TIMER button is pressed once to cancel the function and then again, the unit continues to operate for one hour from that point in time and then stops.
- It is not possible to use the OFF Timer and 1-Hour OFF Timer together. Whichever function is set last takes precedence. If the 1 HR. TIMER button is pressed while the TIMER OFF function operates, the OFF Timer is cancelled and the unit will stop operating one hour later.

2. Operation together with the daily ON/OFF repeat timer

The 1-Hour OFF Timer setting is given priority over the DAILY ON/OFF REPEAT setting.

ADJUSTING THE AIRFLOW DIRECTION

The vertical airflow can be adjusted by moving the flap with the remote controller. Do not move the flap with your hands. Confirm that the remote controller has been turned on. Use the FLAP button to set either the sweep function or one of the six airflow direction settings.

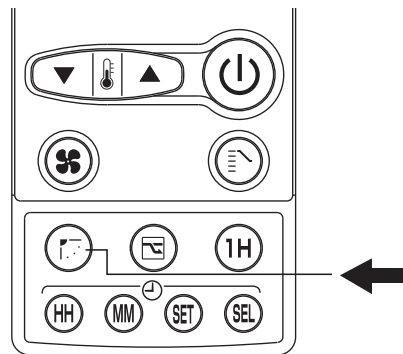

A. Sweep function



The flap starts moving up and down to deliver air over the sweep range.

B. Setting the airflow manually



Referring to the above illustration, use the FLAP button to set the airflow direction within the range used during the heating, cooling, or dehumidifying operation.

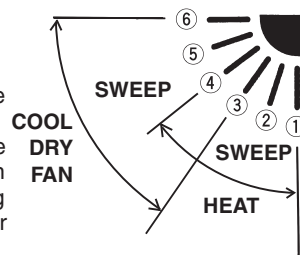

NOTE

- The flap automatically closes when the unit is off.
- During the heating operation, the fan speed will be very low and the flap will be in the horizontal position (position ⑥) until the air being blown out of the unit begins to warm. Once the air warms up, the flap position and fan speed change to the settings specified with the remote controller.



CAUTION

- Use the FLAP button on the remote controller to adjust the position of the flap. If you move the flap by hand, the flap position according to the remote controller and the actual flap position may no longer match. If this should happen, shut off the unit, wait for the flap to close, and then turn on the unit again; the flap position will now be normal again.
- Do not have the flap pointed down during cooling operation. Condensation may begin to form around the air vent and drip down.

APPENDIX B **INSTALLATION INSTRUCTIONS**
(CZ-RD515U)

CZ-RD515U

(852-6-4190-592-00-0)

INSTALLATION INSTRUCTIONS

Wired Remote Controller

IMPORTANT

- In order to install this wired remote controller onto a wall-mounted model, the connection kit (CZ-RC515U or CZ-RC515UA), which must be purchased separately, is required.
- Once the wired remote controller is connected, the wireless remote controller cannot be used.

Parts supplied with the remote controller

See Table 1.

Remote controller installation guidelines

Installation location

- Mount the remote controller 3.3 to 4.9 ft. (1 to 1.5 meters) off the floor where it can sense the average temperature of the room.
- Do not mount the remote controller in a place exposed to direct sunlight or where it is exposed to outside air such as near a window.
- Do not mount the remote controller behind a curtain or other object so that it is separated from the air circulation of the room.
- Mount the remote controller inside the room being air conditioned.

Switching the room temperature sensor

Room temperature sensors are separately incorporated in both the indoor unit and the remote controller. Either sensor can be used to sense the room temperature. The indoor unit sensor is usually used.

If you wish the remote controller to sense the room temperature, press the SENSOR button with a ballpoint pen or tool with a small tip. (Refer to Fig. 9 on page 4 to locate the SENSOR button.)

How to install the remote controller

IMPORTANT

- The remote controller is set to “Cool/Dry/Heat model” at the time of shipment from the factory. If the purchased air conditioner is a COOL/DRY model, follow the instructions on the label and change the switch on the reverse side of the remote controller unit to “Cool/Dry model”. (Fig. 1)
- The remote controller is also set to “Single” at the time of shipment from the factory. For multiple use, set the switch on the reverse side of the remote controller unit to “Multi”. (Fig. 1)
- After all work is completed, if any switches have been changed, then be sure to press the ACL (Reset) button. (Refer to Fig. 9 on page 4 to locate the ACL (Reset) button.)

Table 1

| Parts | Figure | Q'ty | Parts | Figure | Q'ty |
|-------------------------|---------------------------------|------|---------------------------|-------------------|------|
| Wired remote controller | | 1 | Wire harness | 26.2 ft. (8m) | 1 |
| Machine screws | 5/32 × 15/16" (4 × 25mm) | 2 | Instruction manual | | 1 |
| Tapping screws | 5/32 × 15/16" (4 × 25mm) | 2 | Installation Instructions | | 1 |
| Spacers | | 2 | | | |

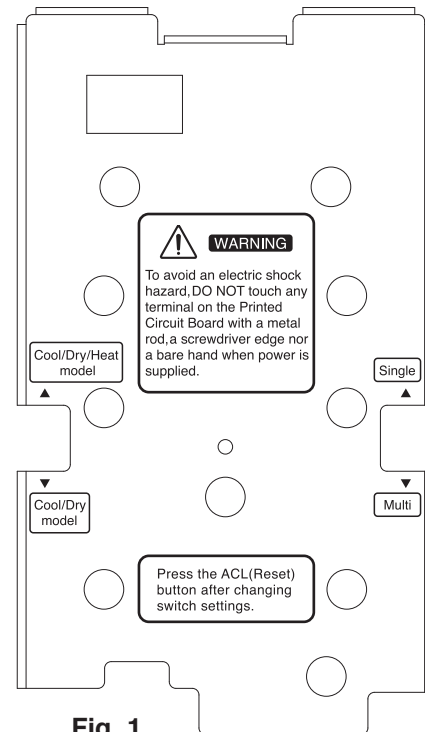

Fig. 1

A. Installing with in-wall junction box

- (1) Install the junction box (locally purchased) into the wall. (Figs. 2-a and 3)
- (2) Pass the wire harness through the junction box and conduit. (Fig. 3)
- (3) Insert a flathead screwdriver into the 5 tab locations and disconnect the back plate of the remote controller by lifting up slightly. (Fig. 2-b)
The tabs are thin; take care not to chip them.
- (4) Pass the wire harness connector through the cord opening on the back plate of the remote controller.
- (5) Use nippers or a similar tool to cut out the slots for the remote controller back plate screws. Insert the spacers and use the machine screws to install the remote controller back plate. (Fig. 3)
- (6) Insert the connector into the PCB of the remote controller unit, and wrap the wire harness around the hook. (Fig. 4)
- (7) Store the excess wire harness inside the junction box, then hook the remote controller unit onto the top of the back plate and install the remote controller unit.
- (8) To remove the remote controller unit after it has been installed, insert a flathead screwdriver into the slot on the bottom of the case and turn it. (Fig. 5)

In-wall junction box (locally purchased)

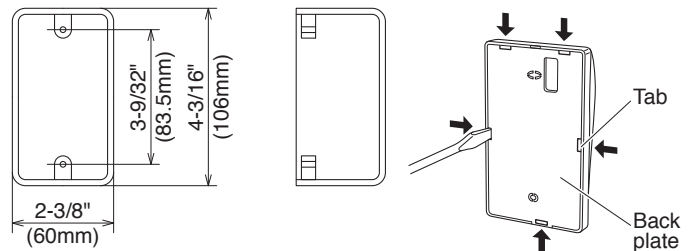

Fig. 2-a

Fig. 2-b

B. Installing directly onto the wall

- (1) Insert a flathead screwdriver into the 5 tab locations and disconnect the back plate of the remote controller by lifting up slightly. (Fig. 2-b)
The tabs are thin; take care not to chip them.
- (2) Use tapping screws to directly fasten the remote controller back plate onto the wall. (Fig. 6)
- (3) Insert the connector into the PCB of the remote controller unit, and wrap the wire harness around the hook. (Fig. 4)
- (4) Use nippers or a similar tool to cut out the slot on the top of the remote controller unit. Pass the wire harness through the slot, then hook the remote controller unit onto the top of the back plate and install the remote controller unit.
- (5) In order to conceal the exposed wiring, use a wire cover (locally purchased) or similar means.

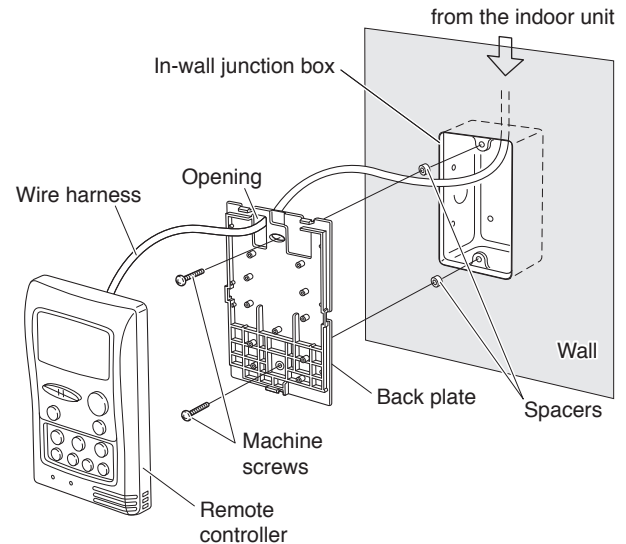

Fig. 3

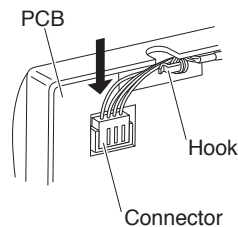

Fig. 4

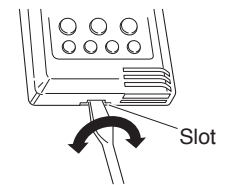

Fig. 5

NOTE

- When installing the remote controller back plate, be sure that it is flat and straight. Do not over-tighten the installation screws.
- Install the remote controller away from all sources of electrical noise.
- Install a noise filter or take other appropriate action if electrical noise affects the power supply circuit of the unit.

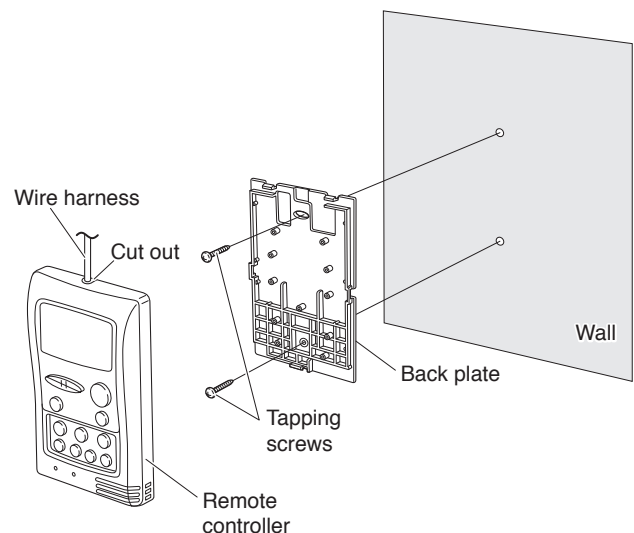

Fig. 6

■ How to wire the remote controller

- (1) Turn OFF the power and remove the ceiling panel air-intake grille. (Refer to **3-6-1 Before Installing the Ceiling Panel** in the Installation Instructions supplied with the indoor unit.)
- (2) Remove the 3 power box cover screws and 2 control box cover screws, then remove both covers. At this time, take care not to drop the covers. (Fig. 7)
- (3) Disconnect the 7P (IND) terminal and 4P (RC) terminal of the 7P IND and 4P RC wiring connectors and the 5P terminal of the 5P FLAP wiring connector from the control box PCB connectors (IND, RC, FLAP). Disconnect each wiring connector from the clamp that fastens it. (Fig. 7)
- (4) Remove the ceiling panel. (To remove the ceiling panel, follow the steps for **3-6 How to Install the Ceiling Panel** in the reverse order. Refer to the Installation Instructions supplied with the indoor unit.)

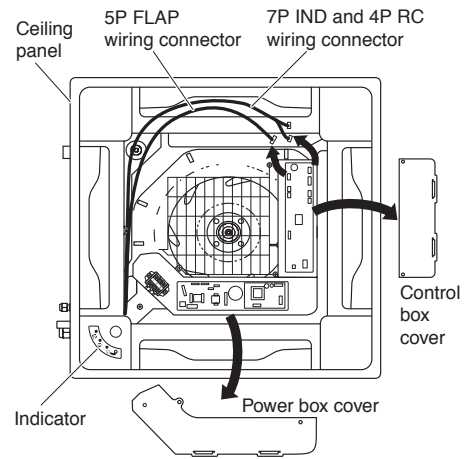

Fig. 7

Fig. 8-a

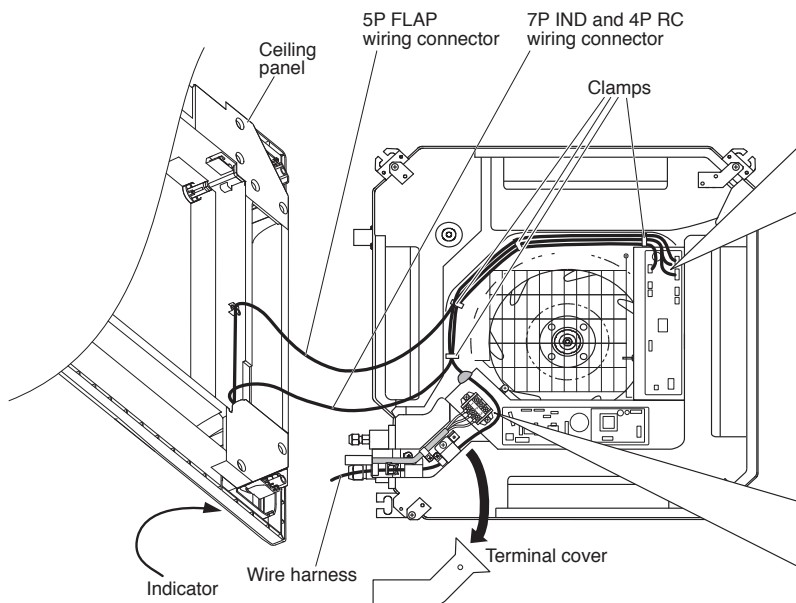

Fig. 8

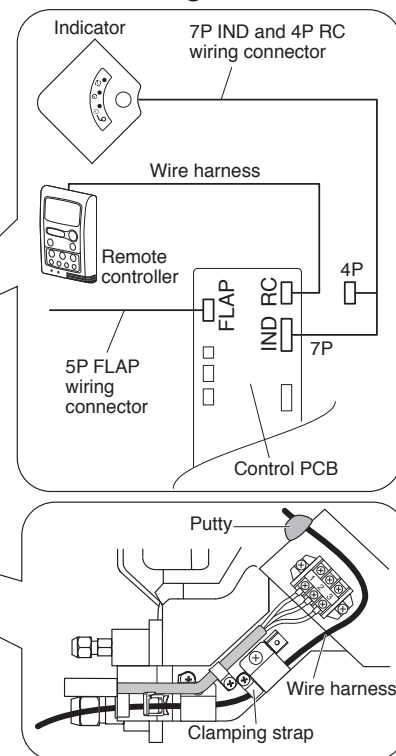

Fig. 8-b

- (5) Remove the terminal cover screws, then remove the cover. At this time, take care not to drop the cover. (Fig. 8)
- (6) Pull in the wire harness from the remote controller as shown in Fig. 8-b.
 - Remove the putty before wiring. After wiring, make sure to restore the putty.
- (7) Insert the wire harness 4P terminal into the control box PCB connector (RC). (Fig. 8-a)
- (8) Install the terminal cover. Then install the ceiling panel. (Refer to **3-6 How to Install the Ceiling Panel** in the Installation Instructions supplied with the indoor unit.)
- (9) Insert only the 7P (IND) terminal of the 7P IND and 4P RC wiring connector into the connector (IND) on the control box PCB. Store the 4P terminal inside the control box. (Fig. 8-a)
- (10) Next, insert the 5P terminal of the 5P FLAP wiring connector into the connector (FLAP) on the control box PCB. (Fig. 8-a)
- (11) When the connections are completed, fasten the wire harness and each wiring connector with the clamps.
- (12) Install the power box cover and control box cover.
- (13) Install the air-intake grille. (Refer to **3-6 How to Install the Ceiling Panel** in the Installation Instructions supplied with the indoor unit.)

■ How to Test Run the Air Conditioner

After turning on the power of the air conditioner, use the remote controller and follow the steps below to conduct the test run.

- (1) Set the remote controller in Test Run mode. (Fig. 9)
 - a) Press and hold the NIGHT SETBACK button and the 1HR. TIMER button.
 - b) Then press and hold the ACL (Reset) button with a pointed object such as the tip of a pen. After 5 seconds, release the ACL button first.
 - c) Then release the NIGHT SETBACK and 1HR. TIMER buttons.
 - d) ❄ appears and “oP-1” blinking in the remote controller clock display area. (Fig. 10)
- (2) Start Cooling mode test run by pressing the ON/OFF operation button of the remote controller. (Fig. 9)
 - This starts the fan producing uncooled forced air with the 3 indicator lamps (OPERATION lamp, TIMER lamp, and HIGH POWER lamp) on the main unit blinking. (Fig. 11)
 - After 3 minutes, the system shifts into cooling operation, and cool air will start to be felt. Cooling mode test run is unaffected by the room temperature.
- (3) Press the ON/OFF operation button of the remote controller again to stop the test run. (Fig. 9)
- (4) Finally press the ACL (Reset) button of the remote controller to release it from Test Run mode to return to normal mode. (Fig. 9)
 - “❄” and “oP-1” will disappear from the remote controller clock display area.

NOTE

Troubleshooting:

In the event that the green OPERATION lamp is blinking upon powering up the system, an error condition exists. In this case, refer to the self-diagnostics procedure which can be seen by opening the air-intake grille.

IMPORTANT

After the test run is completed, be sure to press the ACL (Reset) button to return to normal mode. The air conditioner will not operate correctly if this is not done.

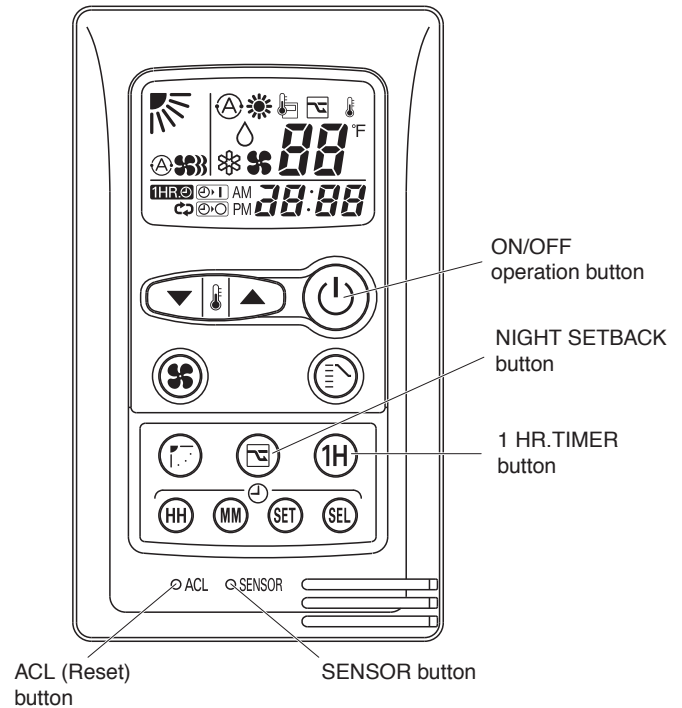

Fig. 9

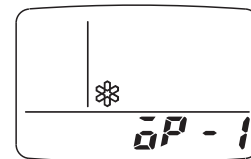

Fig. 10

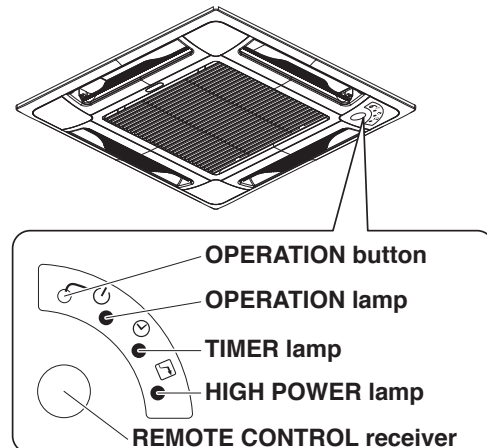

Fig. 11

WI1011-0

Printed in China

APPENDIX C **INSTALLATION INSTRUCTIONS**
(Installing the Connection Kit)
(for Wall-Mounted Models)

CZ-RC515U

(852-6-4190-590-00-0)

INSTALLATION INSTRUCTIONS







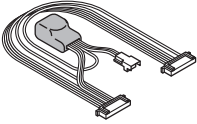

Connection Kit

■ Parts included in the package

See Table 1.

Table 1

| Parts | Figure | Q'ty | Parts | Figure | Q'ty | Parts | Figure | Q'ty |
|----------------------------|-----------------------------------------------------------------------------------|------|---------------|-------------------------------------------------------------------------------------------------------------------------------------|------|----------------|-------------------------------------------------------------------------------------------------------|------|
| Wire (with a noise filter) |  | 1 | Tapping screw |  Truss-head Phillips 5/32×13/32" (4×10mm) | 1 | Clamping strap |  | 1 |
| | | | Clamp |  | 2 | Wire tube |  7-3/32"(180mm) | 1 |
| Installation instructions |  | 1 | Label |  | 1 | | | |

■ Installing the connection kit

A. 7000 BTU, 9000 BTU, and 12000 BTU inverter models

- (1) Remove the air intake grille.
- (2) Remove the terminal cover. Pull out the thermistor, then remove the grille.
 - For details on steps (1) and (2), refer to the Installation Instructions included in the outdoor unit package.
- (3) Disengage the top cover from the tabs on the sides of the component box, then pull the cover toward you to remove it. (Fig. 1)

(To disengage the tabs, pull the sides of the top cover sideways and outward from the component box.)

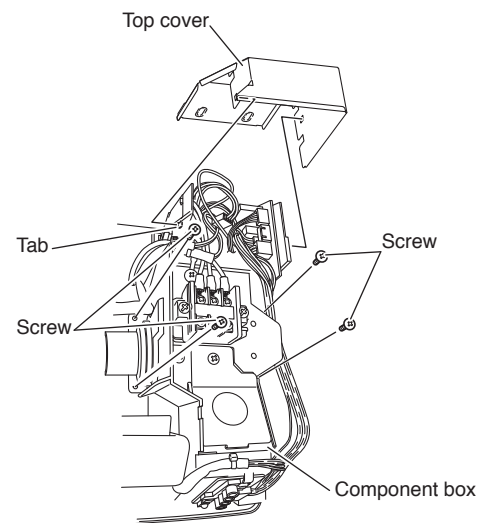

Fig. 1

- (4) Remove the 4 component box installation screws. (Fig. 1)
- (5) Disconnect the indicator-side connector (10P) of the wires that connect the indicator and component box (Fig. 2a). Then disconnect the connector on the component box side (10P) and remove the wires. (Lifting the P.C. board up slightly will make this work easier.) (Fig. 2b)

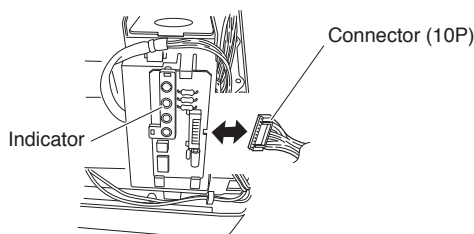

Fig. 2a

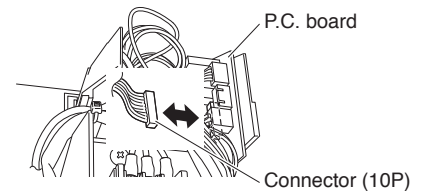

Fig. 2b

- (6) After removing the wires, insert Connector 1 of the wires (Fig. 3a) that were included in the kit package into the indicator (Fig. 2a), then insert Connector 2 into the component box. (Fig. 2b)

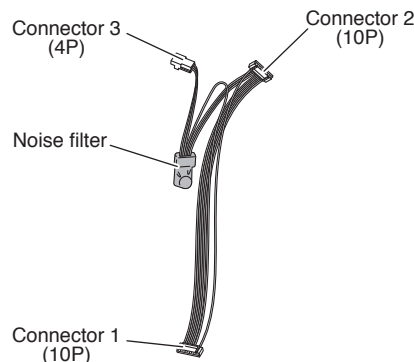

Fig. 3a

At this time, pass the wires through so that they are held inside the 2 holders on the sides of the component box. (Fig. 3b)

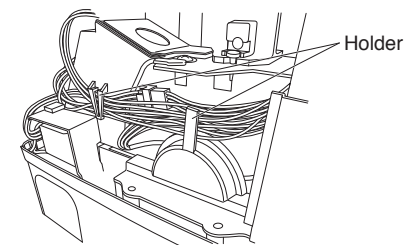

Fig. 3b

- (7) Feed the wire harness that was included in the wired remote controller package into the right lower rear of the unit and route it to the component box. (Fig. 4a)
- When feeding the wire harness through the opening, be careful of the motor cable and be sure to feed the wire harness and motor cable together through the opening. (Fig. 4b)
 - Be careful not to damage the wire harness when installing the conduit during unit installation work.

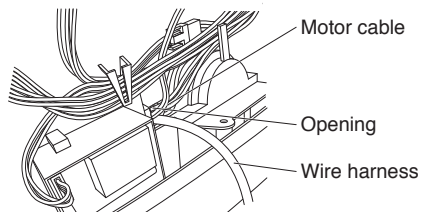

Fig. 4b

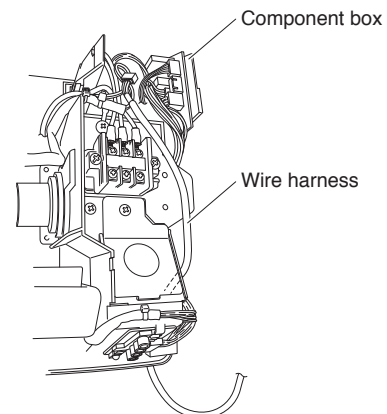

Fig. 4a

- (8) Cut the wire tube that was included in the kit package to a length of approximately 4 inches (100 mm), then feed the wire harness through it. Then connect Connector 3 (Fig. 3a) to the wire harness connector (4P). (Fig. 4c)
- (9) Take the wires (Fig. 3a) and use a wire clamp to bind together the wire for the noise filter and the wire for the thermistor (Fig. 5a). Then position them so that the noise filter is contained within the space of the component box. (Fig. 5b)

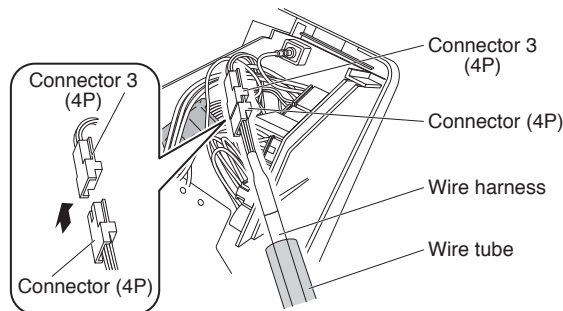

Fig. 4c

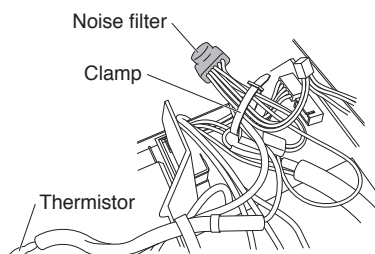

Fig. 5a

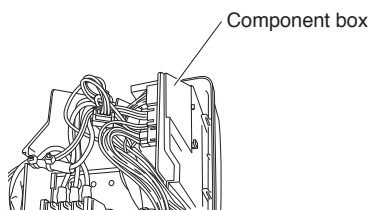

Fig. 5b

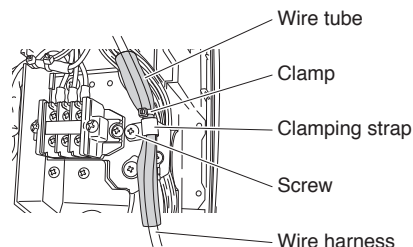

Fig. 6a

- (10) Pass the wire tube through the clamping strap, and temporarily fasten in place with the screw. Next, use a clamp and bind the wires together immediately above the clamping strap, and fasten in place with the screw in order to prevent pulling on the wire harness. (Fig. 6a)
- Install the wire tube so that the wires cannot be damaged by the edge of the metal plate. (Fig. 6a)
 - When re-installing the grille, confirm that there is no slack in the wire harness wires.

- (11) Tighten the 4 screws to install the component box, taking care not to pinch any of the wires, then install the top cover. (Fig. 6b)

- (12) Route the wire harness out through the small cut-out located at the bottom right side of the indoor unit frame. (Fig. 7a)

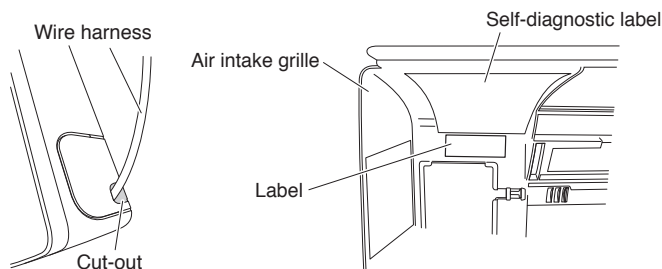

Fig. 7a

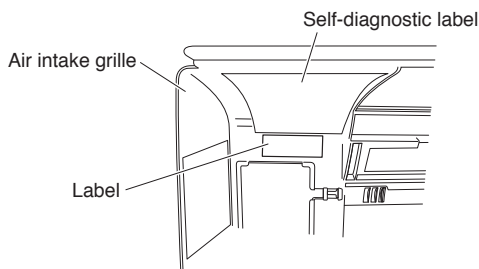
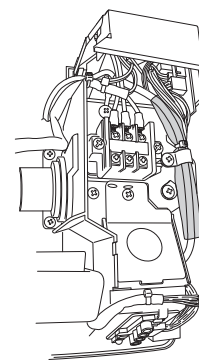

Fig. 7b

- (13) Apply the label that was included in the package at a location close to the self-diagnostic label applied to the air intake grille. (Fig. 7b)

- (14) Refer to the Installation Instructions that were included in the outdoor unit package and re-install the grille, thermistor, terminal cover, and air intake grille.



< Completion drawing >

Fig. 6b

B. 18000 BTU and 24000 BTU inverter models

- (1) Remove the air intake grille.
- (2) Remove the terminal cover. Pull out the thermistor, then remove the grille.
 - For details on steps (1) and (2), refer to the Installation Instructions included in the outdoor unit package.
- (3) Disengage the top cover from the tabs on the sides of the component box, then pull the cover toward you to remove it. (Fig. 1)
(To disengage the tabs, pull the sides of the top cover sideways and outward from the component box.)
- (4) Disconnect the indicator-side connector (10P) of the wires that connect the indicator and component box (Fig. 2a). Then disconnect the connector on the component box side (10P) and remove the wires. (Lifting the P.C. board up slightly will make this work easier.) (Fig. 2b)
- (5) After removing the wires, insert Connector 1 of the wires (Fig. 3a) that were included in the kit package into the indicator (Fig. 2a), then insert Connector 2 into the component box. (Fig. 2b)
At this time, pass the wires through so that they are held inside the 2 holders on the sides of the component box. (Fig. 3b)
- (6) Feed the wire harness that was included in the wired remote controller package into the right lower rear of the unit. (Fig. 4a)
 - Be careful not to damage the wire harness when installing the conduit during unit installation work.
- (7) Pass the wire harness through the wire tube that was included in the kit package. Then connect Connector 3 (Fig. 3a) to the wire harness connector (4P). (Fig. 4c)
- (8) Take the wires (Fig. 3a) and use a wire clamp to bind together the wire for the noise filter and the wire for the thermistor (Fig. 5a). Then position them so that the noise filter is contained within the space of the component box. (Fig. 5b)
- (9) Pass the wire tube through the clamping strap, and temporarily fasten in place with the screw. Next, use a clamp and bind the wires together immediately above the clamping strap, and fasten in place with the screw in order to prevent pulling on the wire harness. (Fig. 6a)
 - Install the wire tube so that the wires cannot be damaged by the edge of the metal plate. (Fig. 6a)
 - When re-installing the grille, confirm that there is no slack in the wire harness wires.
- (10) Install the top cover on the component box. (Fig. 8)
- (11) Route the wire harness out through the small cut-out located at the bottom right side of the indoor unit frame. (Fig. 7a)
- (12) Apply the label that was included in the package at a location close to the self-diagnostic label applied to the air intake grille. (Fig. 7b)
- (13) Refer to the Installation Instructions that were included in the outdoor unit package and re-install the grille, thermistor, terminal cover, and air intake grille.

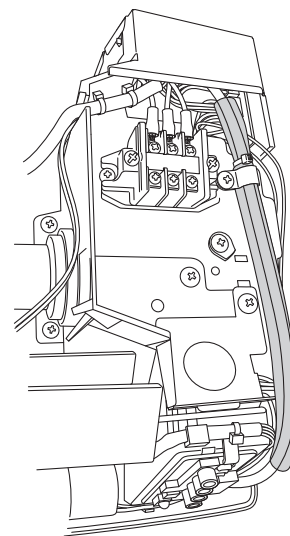

< Completion drawing >

Fig. 8

■ How to Test Run the Air Conditioner

After turning on the power of the air conditioner, use the remote controller and follow the steps below to conduct the test run.

- (1) Set the remote controller in Test Run mode. (Fig. 9)
 - a) Press and hold the NIGHT SETBACK button and the 1HR. TIMER button.
 - b) Then press and hold the ACL (Reset) button with a pointed object such as the tip of a pen. After 5 seconds, release the ACL button first.
 - c) Then release the NIGHT SETBACK and 1HR. TIMER buttons.
 - d) ❄️ appears with “oP-1” blinking in the remote controller clock display area. (Fig. 10)
- (2) Start Cooling mode test run by pressing the ON/OFF operation button of the remote controller. (Fig. 9)
 - This starts the fan producing uncooled forced air with the 3 indicator lamps (OPERATION lamp, TIMER lamp, and QUIET lamp) on the main unit blinking. (Fig. 11)
 - After 3 minutes, the system shifts into cooling operation, and cool air will start to be felt. Cooling mode test run is unaffected by the room temperature.
- (3) Press the ON/OFF operation button of the remote controller again to stop the test run. (Fig. 9)
- (4) Finally press the ACL (Reset) button of the remote controller to release it from Test Run mode to return to normal mode. (Fig. 9)
 - “❄️” and “oP-1” will disappear from the remote controller clock display area.

NOTE

Troubleshooting:

In the event that the green OPERATION lamp is blinking upon powering up the system, an error condition exists. In this case, refer to the self-diagnostics procedure on the inside of the air-intake grille.

IMPORTANT

After the test run is completed, be sure to press the ACL (Reset) button to return to normal mode. The air conditioner will not operate correctly if this is not done.

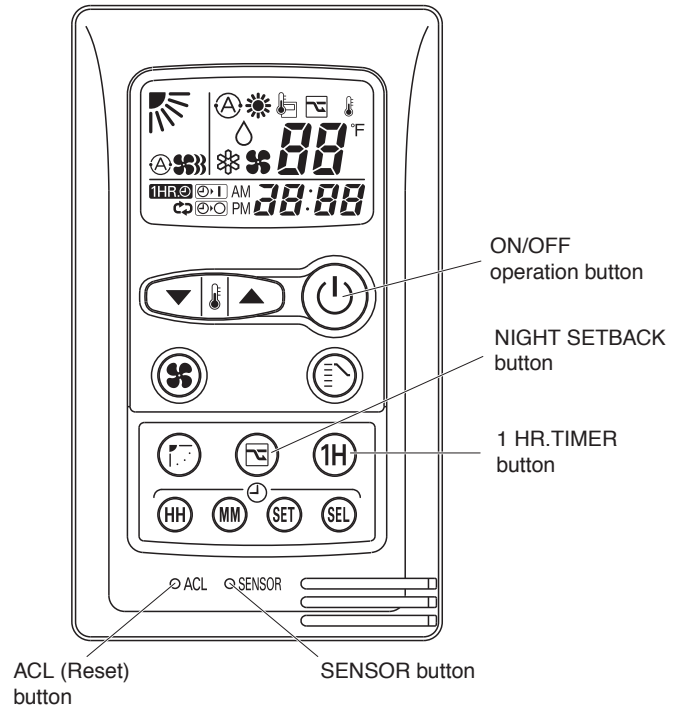

Fig. 9

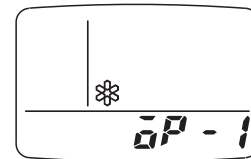

Fig. 10

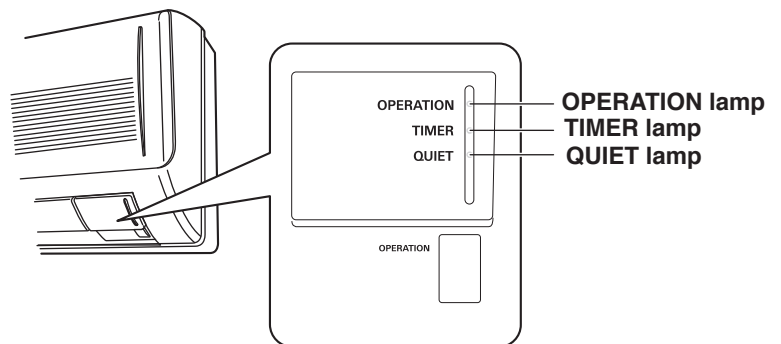

Fig. 11

WI1011-0

Printed in Japan

APPENDIX D **INSTALLATION INSTRUCTIONS**
(Installing the Connection Kit)
(for Wall Mounted Type 2)

CZ-RC515UA

(852-6-4190-591-00-0)

INSTALLATION INSTRUCTIONS







Connection Kit

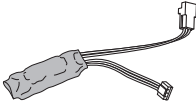

■ Parts included in the package

See Table 1.

Table 1

| Parts | Figure | Q'ty | Parts | Figure | Q'ty | Parts | Figure | Q'ty |
|--------------|-----------------------------------------------------------------------------------|------|---------------|-----------------------------------------------------------------------------------|------|---------------------------|-------------------------------------------------------------------------------------|------|
| Noise filter |  | 1 | Tapping screw |  | 1 | Clamping strap |  | 1 |
| Label |  | 1 | Clamp |  | 2 | Installation instructions |  | 1 |

■ Installing the connection kit

- (1) Remove the air intake grille.
 - For the details of step (1), refer to the Installation Instructions that were provided with the outdoor unit.
- (2) Disengage the tab on the bottom of the electrical box cover, then lift up the cover and disengage the tab on the top of the cover. Then remove the electrical box cover. (Fig. 1)
- (3) Disconnect Connector 1 (7P), Connector 2 (9P), and Connector 3 (5P) from the PC board (PCB). (Fig. 2)
- (4) Draw the PCB approximately half-way out of the electrical box. When drawing it out, push the retainer tab that fastens the PCB in place slightly toward the outside. (Fig. 3)

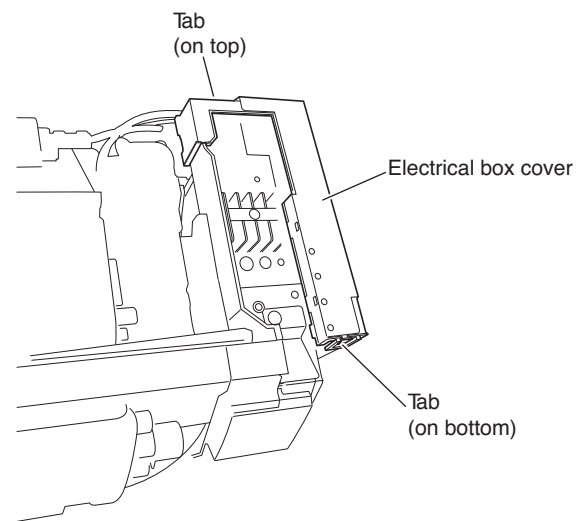

Fig. 1



CAUTION

Draw the PCB out carefully so that the wiring inside the electrical box does not damage the capacitor, IC, or other components.

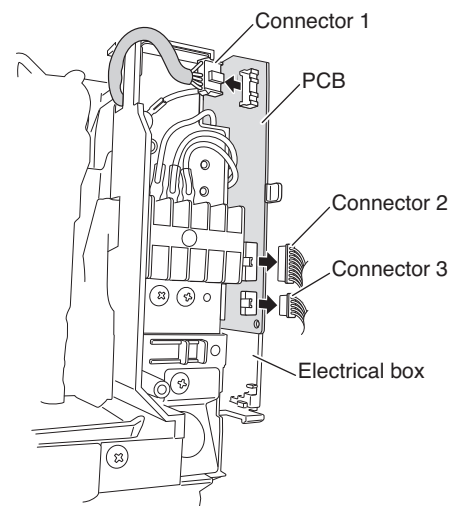

Fig. 2

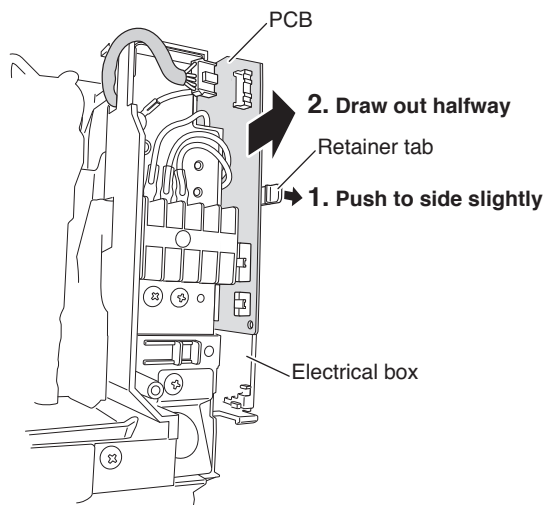

Fig. 3

- (5) Move the jumper cap to WD (Fig. 4), then connect the noise filter Connector A (3P) to the PCB socket (LAMP-1) and connect the other noise filter Connector B (4P) to the wire harness connector (4P) on the wired remote controller. (Fig. 5)

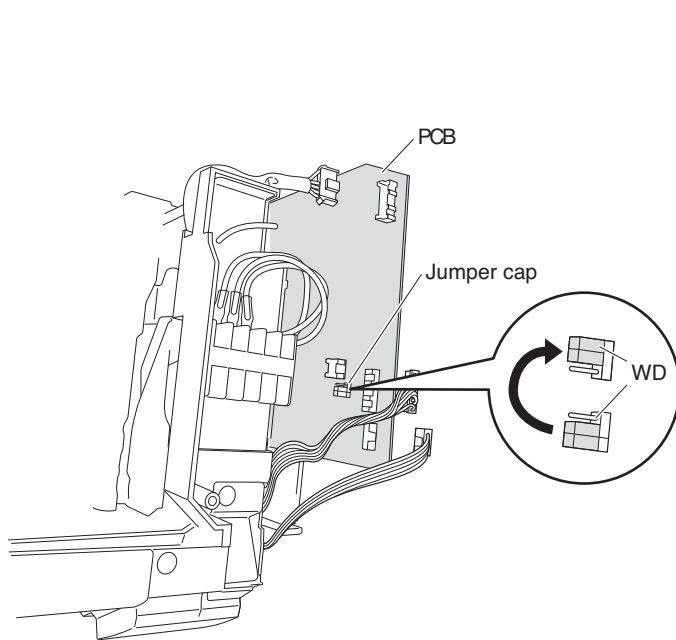

Fig. 4

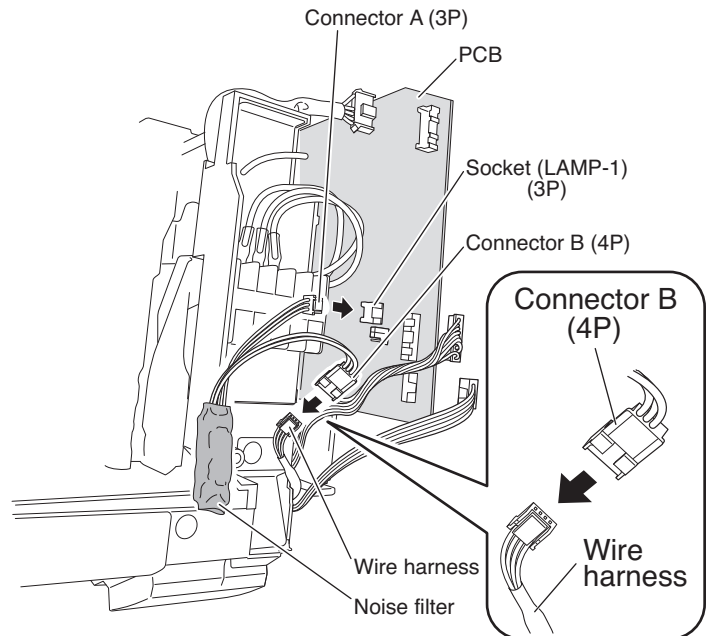

Fig. 5

- (6) Insert the PCB back into its original location in the electrical box.
- (7) Reconnect the three connectors that were removed in step (3).
- (8) Pass the wire harness from the wired remote controller through the clamping strap, and tighten the clamping strap screw. (Fig. 6)

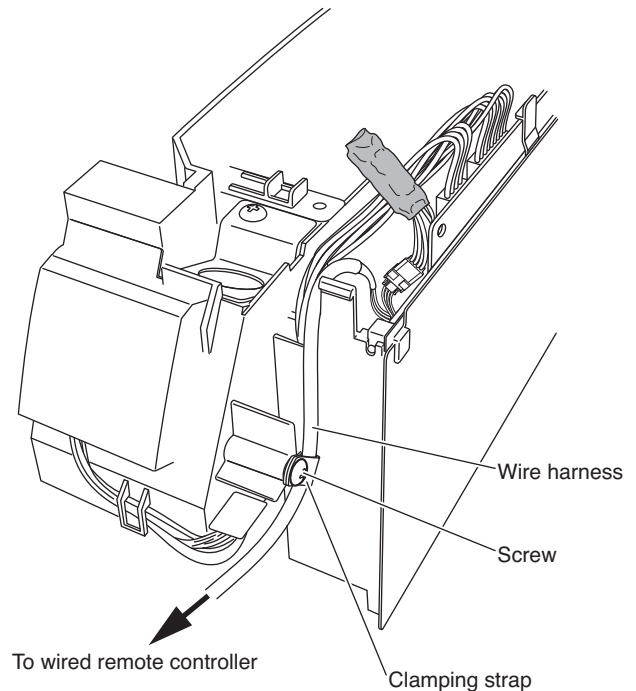

Fig. 6

(9) Insert the noise filter into the electrical box, then fasten the noise filter Connector B wire and the wire harness of the wired remote controller as shown in the figure. (Fig. 7)

(10) In order to prevent pulling on the harness, fasten the part immediately above the strap with a clamp. (Fig. 8)

NOTE After fastening, cut away the excess part of the clamp.

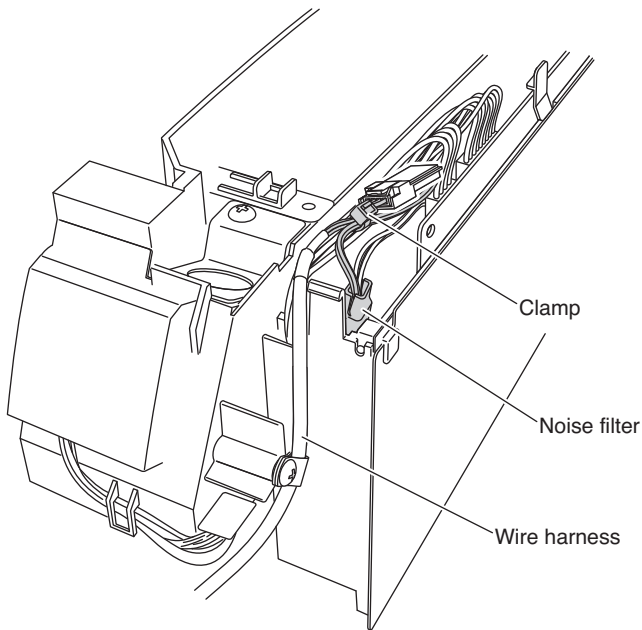

Fig. 7

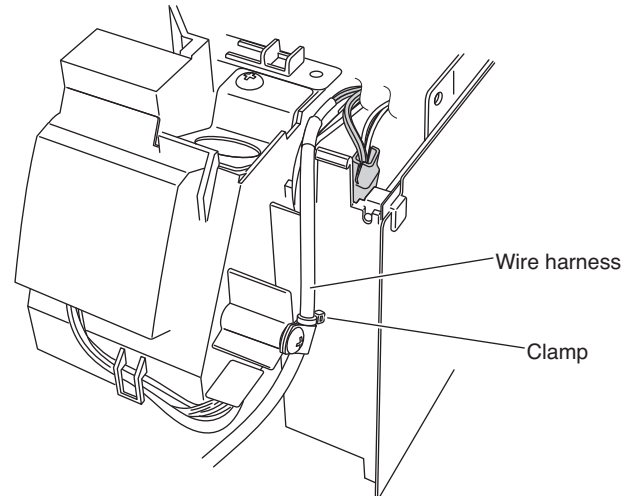

Fig. 8

(11) Reinstall the electrical box cover.

(12) Apply the supplied label close to the self-diagnostics label on the inside of the removed air-intake grille. (Fig. 9)

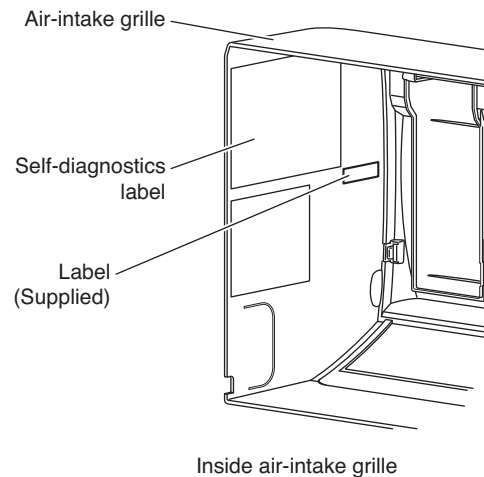

Fig. 9

(13) Reinstall the air-intake grille.

- For the details of step (13), refer to the Installation Instructions that were provided with the outdoor unit.

When installing the air-intake grille, install it so that the wire harness for the wired remote controller emerges from the small open hole on the right side of the grille. (Fig. 10)

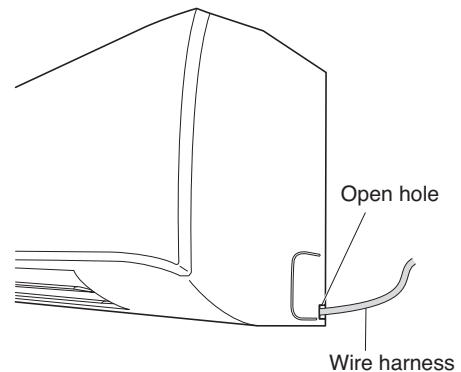

Fig. 10

■ How to Test Run the Air Conditioner

After turning on the power of the air conditioner, use the remote controller and follow the steps below to conduct the test run.

- (1) Set the remote controller in Test Run mode. (Fig. 11)
 - a) Press and hold the NIGHT SETBACK button and the 1HR. TIMER button.
 - b) Then press and hold the ACL (Reset) button with a pointed object such as the tip of a pen. After 5 seconds, release the ACL button first.
 - c) Then release the NIGHT SETBACK and 1HR. TIMER buttons.
 - d) ❄️ appears with “oP-1” blinking in the remote controller clock display area. (Fig. 12)
- (2) Start Cooling mode test run by pressing the ON/OFF operation button of the remote controller. (Fig. 11)
 - This starts the fan producing uncooled forced air with the 3 indicator lamps (OPERATION lamp, TIMER lamp, and ❄️) on the main unit blinking. (Fig. 13)
 - After 3 minutes, the system shifts into cooling operation, and cool air will start to be felt. Cooling mode test run is unaffected by the room temperature.
- (3) Press the ON/OFF operation button of the remote controller again to stop the test run. (Fig. 11)
- (4) Finally press the ACL (Reset) button of the remote controller to release it from Test Run mode to return to normal mode. (Fig. 11)
 - “❄️” and “oP-1” will disappear from the remote controller clock display area.

NOTE

Troubleshooting:

In the event that the green OPERATION lamp is blinking upon powering up the system, an error condition exists. In this case, refer to the self-diagnostics procedure on the inside of the air-intake grille.

IMPORTANT

After the test run is completed, be sure to press the ACL (Reset) button to return to normal mode. The air conditioner will not operate correctly if this is not done.

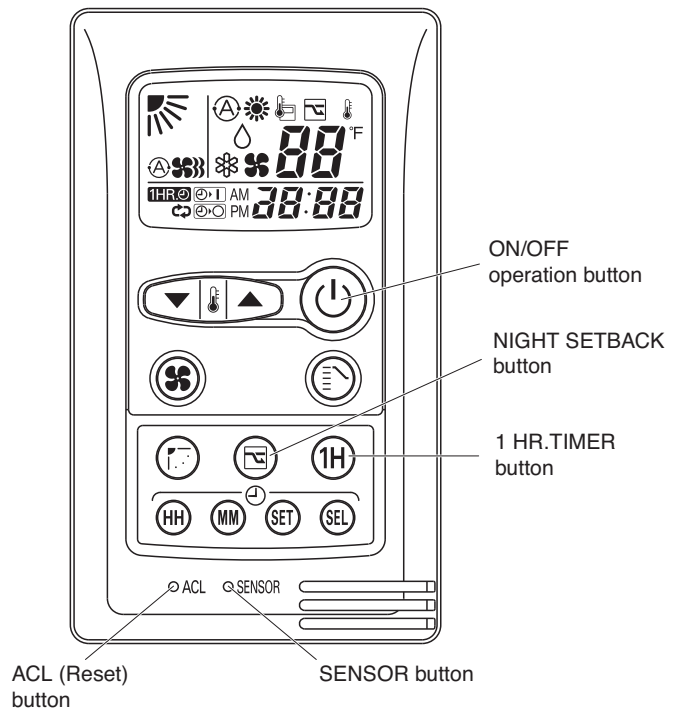

Fig. 11

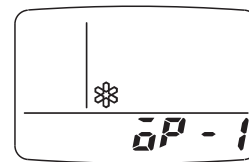

Fig. 12

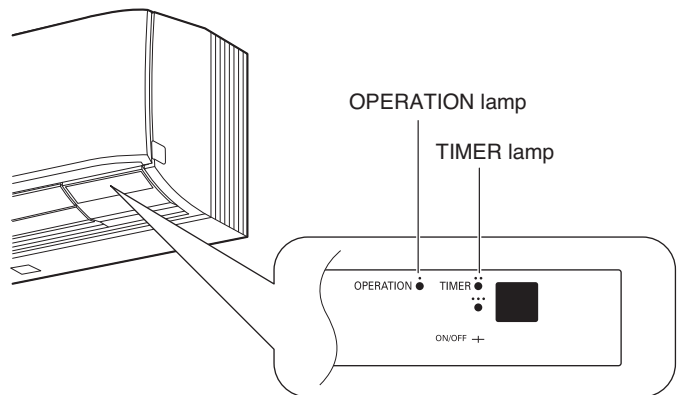

Fig. 13

